

Rampage III Formula

ASUS®

Motherboard

E5997

First Edition
August 2010

Copyright © 2010 ASUSTeK COMPUTER INC. All Rights Reserved.

No part of this manual, including the products and software described in it, may be reproduced, transmitted, transcribed, stored in a retrieval system, or translated into any language in any form or by any means, except documentation kept by the purchaser for backup purposes, without the express written permission of ASUSTeK COMPUTER INC. ("ASUS").

Product warranty or service will not be extended if: (1) the product is repaired, modified or altered, unless such repair, modification or alteration is authorized in writing by ASUS; or (2) the serial number of the product is defaced or missing.

ASUS PROVIDES THIS MANUAL "AS IS" WITHOUT WARRANTY OF ANY KIND, EITHER EXPRESS OR IMPLIED, INCLUDING BUT NOT LIMITED TO THE IMPLIED WARRANTIES OR CONDITIONS OF MERCHANTABILITY OR FITNESS FOR A PARTICULAR PURPOSE. IN NO EVENT SHALL ASUS, ITS DIRECTORS, OFFICERS, EMPLOYEES OR AGENTS BE LIABLE FOR ANY INDIRECT, SPECIAL, INCIDENTAL, OR CONSEQUENTIAL DAMAGES (INCLUDING DAMAGES FOR LOSS OF PROFITS, LOSS OF BUSINESS, LOSS OF USE OR DATA, INTERRUPTION OF BUSINESS AND THE LIKE), EVEN IF ASUS HAS BEEN ADVISED OF THE POSSIBILITY OF SUCH DAMAGES ARISING FROM ANY DEFECT OR ERROR IN THIS MANUAL OR PRODUCT.

SPECIFICATIONS AND INFORMATION CONTAINED IN THIS MANUAL ARE FURNISHED FOR INFORMATIONAL USE ONLY, AND ARE SUBJECT TO CHANGE AT ANY TIME WITHOUT NOTICE, AND SHOULD NOT BE CONSTRUED AS A COMMITMENT BY ASUS. ASUS ASSUMES NO RESPONSIBILITY OR LIABILITY FOR ANY ERRORS OR INACCURACIES THAT MAY APPEAR IN THIS MANUAL, INCLUDING THE PRODUCTS AND SOFTWARE DESCRIBED IN IT.

Products and corporate names appearing in this manual may or may not be registered trademarks or copyrights of their respective companies, and are used only for identification or explanation and to the owners' benefit, without intent to infringe.

Contents

Notices.....	viii
Safety information.....	ix
About this guide.....	xi
Rampage III Formula specifications summary.....	xiii

Chapter 1: Product introduction

1.1	Welcome!.....	1-1
1.2	Package contents.....	1-1
1.3	Special features.....	1-2
1.3.1	Product highlights.....	1-2
1.3.2	ROG Intelligent Performance & Overclocking features... ..	1-3
1.3.3	ROG unique features.....	1-6
1.3.4	ASUS special features.....	1-7

Chapter 2: Hardware information

2.1	Before you proceed.....	2-1
2.2	Motherboard overview.....	2-6
2.2.1	Motherboard layout.....	2-6
2.2.2	Layout contents.....	2-7
2.2.3	Placement direction.....	2-8
2.2.4	Screw holes.....	2-8
2.3	Central Processing Unit (CPU).....	2-9
2.3.1	Installing the CPU.....	2-9
2.3.2	Installing the CPU heatsink and fan.....	2-12
2.3.3	Uninstalling the CPU heatsink and fan.....	2-13
2.4	System memory.....	2-14
2.4.1	Overview.....	2-14
2.4.2	Memory configurations.....	2-15
2.4.3	Installing a DIMM.....	2-25
2.4.4	Removing a DIMM.....	2-25
2.5	Expansion slots.....	2-26
2.5.1	Installing an expansion card.....	2-26
2.5.2	Configuring an expansion card.....	2-26
2.5.3	Interrupt assignments.....	2-27
2.5.4	PCI slot.....	2-28
2.5.5	PCI Express x1 slots.....	2-29
2.5.6	PCI Express x16 slots.....	2-29

Contents

2.6	Jumper	2-30
2.7	I/O shield Installation	2-32
2.8	Connectors	2-33
2.8.1	Rear panel connectors	2-33
2.8.2	ROG Connect switch	2-34
2.8.3	Audio I/O connections	2-35
2.8.4	Internal connectors	2-38
2.8.5	Onboard switches	2-48
2.8.6	Probelt	2-51
2.9	Starting up for the first time	2-52
2.10	Turning off the computer	2-53
2.10.1	Using the OS shut down function	2-53
2.10.2	Using the dual function power switch	2-53
 Chapter 3: BIOS Setup		
3.1	Managing and updating your BIOS	3-1
3.1.1	ASUS Update utility	3-1
3.1.2	ASUS EZ Flash 2 utility	3-4
3.1.3	ASUS CrashFree BIOS 3 utility	3-5
3.2	BIOS Setup program	3-6
3.2.1	BIOS menu screen	3-7
3.2.2	Menu bar	3-7
3.2.3	Navigation keys	3-7
3.2.4	Menu items	3-8
3.2.5	Submenu items	3-8
3.2.6	Configuration fields	3-8
3.2.7	Pop-up window	3-8
3.2.8	Scroll bar	3-8
3.2.9	General help	3-8
3.3	Extreme Tweaker menu	3-9
3.3.1	CPU Level Up [Auto]	3-10
3.3.2	Sync Mode [Enabled]	3-10
3.3.3	Ai Overclock Tuner [Auto]	3-10
3.3.4	CPU Ratio Setting [Auto]	3-10
3.3.5	CPU Turbo Power Limit [Disabled]	3-11
3.3.6	CPU Configuration	3-11

Contents

3.3.7	BCLK Frequency [XXX]	3-11
3.3.8	PCIe Frequency [XXX]	3-11
3.3.9	DRAM Frequency [Auto]	3-11
3.3.10	UCLK Frequency [Auto]	3-11
3.3.11	QPI Link Data Rate [Auto]	3-11
3.3.12	DRAM Timing Control	3-12
3.3.13	CPU Differential Amplitude [Auto]	3-13
3.3.14	CPU Clock Skew [Auto]	3-14
3.3.15	IOH Clock Skew [Auto]	3-14
3.3.16	Digi+ PWR Mode [T-Balanced]	3-14
3.3.17	PWM Volt. Control [Auto]	3-14
3.3.18	Load-Line Calibration [Auto]	3-14
3.3.19	CPU Voltage OCP [Enabled]	3-14
3.3.20	CPU PWM Frequency [Auto]	3-14
3.3.21	Extreme OV [Disabled]	3-14
3.3.22	Extreme OC [Disabled]	3-14
3.3.23	CPU Voltage [Auto]	3-15
3.3.24	CPU PLL Voltage [Auto]	3-15
3.3.25	QPI/DRAM Core Voltage [Auto]	3-15
3.3.26	DRAM Bus Voltage [Auto]	3-15
3.3.27	DRAM REF Voltages	3-15
3.3.28	IOH Voltage [Auto]	3-15
3.3.29	IOH PCIe Voltage [Auto]	3-15
3.3.30	ICH Voltage [Auto]	3-16
3.3.31	ICH PCIe Voltage [Auto]	3-16
3.3.32	ASUS O.C. Profile	3-16
3.3.33	CPU Spread Spectrum [Auto]	3-16
3.3.34	PCIe Spread Spectrum [Auto]	3-16
3.4	Main menu	3-17
3.4.1	System Time [xx:xx:xx]	3-17
3.4.2	System Date [Day xx/xx/xxxx]	3-17
3.4.3	Language [English]	3-17
3.4.4	SATA 1-6	3-18
3.4.5	Storage Configuration	3-20
3.4.6	AHCI Configuration	3-21
3.4.7	System Information	3-22

Contents

- 3.5 Advanced menu 3-23**
 - 3.5.1 CPU Configuration 3-23
 - 3.5.2 Chipset 3-26
 - 3.5.3 Onboard Devices Configuration 3-27
 - 3.5.4 USB Configuration 3-29
 - 3.5.5 PCIPnP 3-30
 - 3.5.6 LED Control 3-31
 - 3.5.7 iROG Configuration..... 3-32
 - 3.5.8 ROG Connect 3-32
- 3.6 Power menu 3-33**
 - 3.6.1 Suspend Mode [Auto] 3-33
 - 3.6.2 Repost Video on S3 Resume [No] 3-33
 - 3.6.3 ACPI 2.0 Support [Enabled] 3-33
 - 3.6.6 APM Configuration 3-34
 - 3.6.4 ACPI APIC Support [Enabled]..... 3-34
 - 3.6.5 EuP Ready [Disabled]..... 3-34
 - 3.6.7 Hardware Monitor 3-36
- 3.7 Boot menu 3-39**
 - 3.7.1 Boot Device Priority 3-39
 - 3.7.2 Boot Settings Configuration 3-40
 - 3.7.3 Security 3-41
- 3.8 Tools menu 3-43**
 - 3.8.1 ASUS EZ Flash 2 3-43
 - 3.8.2 ASUS O.C. Profile..... 3-44
 - 3.8.3 GO_Button File 3-46
 - 3.8.4 BIOS FlashBack..... 3-47
 - 3.8.5 Drive Xpert Configuration..... 3-48
- 3.9 Exit menu 3-50**

Chapter 4: Software support

- 4.1 Installing an operating system 4-1**
- 4.2 Support DVD information 4-1**
 - 4.2.1 Running the support DVD 4-1
 - 4.2.2 Drivers menu..... 4-2
 - 4.2.3 Utilities menu 4-3
 - 4.2.4 Make disk menu..... 4-4

Contents

4.2.5	Manual menu	4-4
4.2.6	Video menu	4-5
4.2.7	ASUS Contact information	4-5
4.2.8	Other information	4-6
4.3	Software information	4-8
4.3.1	ASUS AI Suite II	4-8
4.3.2	TurboV EVO	4-9
4.3.3	FAN Xpert	4-11
4.3.4	Probe II	4-12
4.3.5	Sensor Recorder	4-14
4.3.6	Sound Blaster X-Fi MB 2	4-15
4.4	RAID configurations	4-18
4.4.1	RAID definitions	4-18
4.4.2	Installing Serial ATA hard disks	4-19
4.4.3	Setting the RAID item in BIOS	4-19
4.4.4	Intel® Matrix Storage Manager option ROM utility	4-20
4.5	Creating a RAID driver disk	4-25
4.5.1	Creating a RAID driver disk without entering the OS	4-25
4.5.2	Creating a RAID driver disk in Windows®	4-25
 Chapter 5: ATI® CrossFireX™ technology support		
5.1	ATI® CrossFireX™ technology	5-1
5.1.1	Requirements	5-1
5.1.2	Before you begin	5-1
5.1.3	Installing CrossFireX graphics cards	5-2
5.1.4	Installing the device drivers	5-3
5.1.5	Enabling the ATI® CrossFireX™ technology	5-3
5.2	NVIDIA® SLI™ technology	5-5
5.2.1	Requirements	5-5
5.2.2	Installing two SLI-ready graphics cards	5-5
5.2.3	Installing the device drivers	5-6
5.2.4	Enabling the NVIDIA® SLI™ technology	5-6

Notices

Federal Communications Commission Statement

This device complies with Part 15 of the FCC Rules. Operation is subject to the following two conditions:

- This device may not cause harmful interference, and
- This device must accept any interference received including interference that may cause undesired operation.

This equipment has been tested and found to comply with the limits for a Class B digital device, pursuant to Part 15 of the FCC Rules. These limits are designed to provide reasonable protection against harmful interference in a residential installation. This equipment generates, uses and can radiate radio frequency energy and, if not installed and used in accordance with manufacturer's instructions, may cause harmful interference to radio communications. However, there is no guarantee that interference will not occur in a particular installation. If this equipment does cause harmful interference to radio or television reception, which can be determined by turning the equipment off and on, the user is encouraged to try to correct the interference by one or more of the following measures:

- Reorient or relocate the receiving antenna.
- Increase the separation between the equipment and receiver.
- Connect the equipment to an outlet on a circuit different from that to which the receiver is connected.
- Consult the dealer or an experienced radio/TV technician for help.



The use of shielded cables for connection of the monitor to the graphics card is required to assure compliance with FCC regulations. Changes or modifications to this unit not expressly approved by the party responsible for compliance could void the user's authority to operate this equipment.

Canadian Department of Communications Statement

This digital apparatus does not exceed the Class B limits for radio noise emissions from digital apparatus set out in the Radio Interference Regulations of the Canadian Department of Communications.

This class B digital apparatus complies with Canadian ICES-003.

REACH

Complying with the REACH (Registration, Evaluation, Authorization, and Restriction of Chemicals) regulatory framework, we published the chemical substances in our products at ASUS website at <http://green.asus.com/english/REACH.htm>.

Safety information

Electrical safety

- To prevent electrical shock hazard, disconnect the power cable from the electrical outlet before relocating the system.
- When adding or removing devices to or from the system, ensure that the power cables for the devices are unplugged before the signal cables are connected. If possible, disconnect all power cables from the existing system before you add a device.
- Before connecting or removing signal cables from the motherboard, ensure that all power cables are unplugged.
- Seek professional assistance before using an adapter or extension cord. These devices could interrupt the grounding circuit.
- Ensure that your power supply is set to the correct voltage in your area. If you are not sure about the voltage of the electrical outlet you are using, contact your local power company.
- If the power supply is broken, do not try to fix it by yourself. Contact a qualified service technician or your retailer.
- The optical S/PDIF is an optional component (may or may not be included in your motherboard) and is defined as a CLASS 1 LASER PRODUCT.



INVISIBLE LASER RADIATION, AVOID EXPOSURE TO BEAM.

- Never dispose of the battery in fire. It could explode and release harmful substances into the environment.
- Never dispose of the battery with your regular household waste. Take it to a hazardous material collection point.
- Never replace the battery with an incorrect battery type.



-
- RISK OF EXPLOSION IF BATTERY IS REPLACED BY AN INCORRECT TYPE.
 - DISPOSE OF USED BATTERIES ACCORDING TO THE ABOVE BATTERY-RELATED INSTRUCTIONS.
-

Operation safety

- Before installing the motherboard and adding devices on it, carefully read all the manuals that came with the package.
- Before using the product, ensure all cables are correctly connected and the power cables are not damaged. If you detect any damage, contact your dealer immediately.
- To avoid short circuits, keep paper clips, screws, and staples away from connectors, slots, sockets and circuitry.
- Avoid dust, humidity, and temperature extremes. Do not place the product in any area where it may become wet.



This motherboard should only be used in environments with ambient temperatures between 5°C (41°F) and 40°C (104°F).

- Place the product on a stable surface.
- If you encounter technical problems with the product, contact a qualified service technician or your retailer.



DO NOT throw the motherboard in municipal waste. This product has been designed to enable proper reuse of parts and recycling. This symbol of the crossed out wheeled bin indicates that the product (electrical and electronic equipment) should not be placed in municipal waste. Check local regulations for disposal of electronic products.



DO NOT throw the mercury-containing button cell battery in municipal waste. This symbol of the crossed out wheeled bin indicates that the battery should not be placed in municipal waste.

About this guide

This user guide contains the information you need when installing and configuring the motherboard.

How this guide is organized

This guide contains the following parts:

- **Chapter 1: Product introduction**
This chapter describes the features of the motherboard and the new technology it supports.
- **Chapter 2: Hardware information**
This chapter lists the hardware setup procedures that you have to perform when installing system components. It includes description of the switches, jumpers, and connectors on the motherboard.
- **Chapter 3: BIOS setup**
This chapter tells how to change system settings through the BIOS Setup menus. Detailed descriptions of the BIOS parameters are also provided.
- **Chapter 4: Software support**
This chapter describes the contents of the support DVD that comes with the motherboard package and the software.
- **Chapter 5: Multiple GPU technology support**
This chapter describes how to install and configure multiple ATI® CrossFireX™ and NVIDIA® SLI™ graphics cards.

Where to find more information

Refer to the following sources for additional information and for product and software updates.

1. **ASUS websites**
The ASUS website provides updated information on ASUS hardware and software products. Refer to the ASUS contact information.
2. **Optional documentation**
Your product package may include optional documentation, such as warranty flyers, that may have been added by your dealer. These documents are not part of the standard package.

Conventions used in this guide

To ensure that you perform certain tasks properly, take note of the following symbols used throughout this manual.



DANGER/WARNING: Information to prevent injury to yourself when trying to complete a task.



CAUTION: Information to prevent damage to the components when trying to complete a task.



IMPORTANT: Instructions that you **MUST** follow to complete a task.



NOTE: Tips and additional information to help you complete a task.

Typography

Bold text

Indicates a menu or an item to select.

Italics

Used to emphasize a word or a phrase.

<Key>

Keys enclosed in the less-than and greater-than sign means that you must press the enclosed key.

Example: <Enter> means that you must press the Enter or Return key.

<Key1+Key2+Key3>

If you must press two or more keys simultaneously, the key names are linked with a plus sign (+).

Example: <Ctrl+Alt+D>

Command

Means that you must type the command exactly as shown, then supply the required item or value enclosed in brackets.

Example: At the DOS prompt, type the command line:

afudos /iR3F.ROM

Rampage III Formula specifications summary

CPU	LGA1366 socket for Intel® Core™ i7 Processor Extreme Edition / Core™ i7 Processor <ul style="list-style-type: none"> - Support Intel® Turbo Boost Technology * Refer to www.asus.com for Intel® CPU support list
Chipset	Intel® X58/ICH10R
System Bus	Up to 6.4 GT/s with QuickPath Interconnection
Memory	Triple channel memory architecture 6 x DIMM, max. 24GB, DDR3 2200(O.C.)/2133(O.C.)/2000(O.C.)/1800(O.C.)/1600/1333/1066 MHz, non-ECC, un-buffered memory modules <ul style="list-style-type: none"> - Supports Intel® Extreme Memory Profile (XMP) *Hyper DIMM support is subject to the physical characteristics of individual CPUs. *Refer to www.asus.com or this user manual for the Memory QVL (Qualified Vendors Lists).
Expansion Slots	3 x PCIe2.0 x16 slots, support x16; x16/x16; x16/x8/x8 configurations 2 x PCIe x1 1 x PCI 2.2
Multi-GPU Technology	Support NVIDIA 3-Way SLI™ / ATI CrossFireX™ Technology
Storage	ICH10R Southbridge: <ul style="list-style-type: none"> - 6 x SATA 3.0 Gb/s ports - Intel Matrix Storage Technology supports RAID 0, 1, 5 and 10 JMicron® 363 controller: <ul style="list-style-type: none"> - 2 x SATA 3.0 Gb/s port (1 x SATA On-the-Go, 1 x power eSATA port) Marvell® 9128 PCIe SATA 6Gb/s controller <ul style="list-style-type: none"> - 2 x SATA 6.0 Gb/s ports
LAN	Intel® Ethernet 82567V Gigabit LAN GameFirst
High Definition Audio	SupremeFX X-Fi 2 onboard <ul style="list-style-type: none"> - 8-channel High Definition Audio CODEC - EAX® Advanced™ HD 5.0 - THX® TrueStudio PRO™ - X-Fi Xtreme Fidelity™ - Creative ALchemy - Supports Blu-ray audio layer content protection - Supports Jack-detection, Multi-streaming, Front Panel Jack-retasking - Supports Optical S/PDIF out ports on rear
IEEE 1394a	2 x 1394a ports (1 port at back I/O, 1 port onboard)

(continued on the next page)

Rampage III Formula specifications summary

USB	<p>NEC® USB 3.0 controller</p> <ul style="list-style-type: none"> - 2 x USB 3.0/2.0 ports (at back panel) <p>Intel® ICH10R Southbridge</p> <ul style="list-style-type: none"> - 12 x USB 2.0/1.1 ports: 6 +1 (ROG Connect) at I/O, 4 (2 USB connectors for 4 ports) + 1 (USB11 also for OC station header)
ROG Exclusive Overclocking Features	<p>ROG Connect ROG Extreme Engine Digi+</p> <ul style="list-style-type: none"> - 8-phase CPU power - 3-phase QPI/DRAM power - 2-phase NB power - 2-phase Memory power <p>ProBelt iROG Extreme Tweaker BIOS Flashback with onboard BIOS switch button Loadline Calibration ROG Extreme OC kit</p> <ul style="list-style-type: none"> - LN2 Mode - Q Reset <p>Intelligent overclocking tools:</p> <ul style="list-style-type: none"> - ASUS AI Booster Utility - O.C Profile <p>Overclocking Protection:</p> <ul style="list-style-type: none"> - COP EX (Component Overheat Protection - EX) - Voltminder LED - ASUS C.P.R.(CPU Parameter Recall)
Other Special Features	<p>CPU Level Up MemOK! Onboard Switches: Power / Reset / Clr CMOS (at rear) ASUS MyLogo3 ASUS Fan Xpert ASUS EZ Flash 2 ASUS CrashFree BIOS 3 Q-Fan Plus ROG BIOS Wallpaper ASUS Q-Connector ASUS Q-LED (CPU, DRAM, VGA, Boot Device LED) ASUS Q-Slot ASUS Q-DIMM</p>
BIOS Features	<p>16Mb AMI BIOS, PnP, DMI2.0, WfM2.0, SM BIOS 2.5, ACPI2.0a Multi-Language BIOS</p>

(continued on the next page)

Rampage III Formula specifications summary

Manageability	WOL by PME, WOR by PME, PXE
Back Panel I/O Ports	<p>1 x PS/2 Keyboard port (purple) 1 x Clr CMOS switch 1 x Optical S/PDIF out port 1 x IEEE 1394a connector 2 x External SATA ports 1 x LAN (RJ45) port 1 x ROG Connect On/Off switch 2 x USB 3.0/2.0 ports (Blue) 7 x USB 2.0/1.1 ports (1 port also for ROG Connect) 8-channel Audio I/O</p>
Internal I/O Connectors	<p>2 x USB 2.0 connector supports additional 4 USB 2.0 ports 8 x SATA connectors: 2 x SATA 6.0 Gb/s connectors (Red); 6 x SATA 3.0 Gb/s connectors (Grey) 8 x Fan connectors: 1 x CPU / 1 x PWR / 3 x Chassis / 3 x Optional 8 x Probelts Measurement Points 3 x Thermal sensor connectors 1 x QPI Loadline calibration switch jumper (QPI_LL_SW) 1 x IEEE1394a connector 1 x SPDIF_Out Connector 1 x 24-pin ATX Power connector 1 x 8-pin ATX 12V Power connector 1 x En/Dis-able Clr CMOS header 1 x LN2 Mode Header 1 x START (Power On) button 1 x RESET button 1 x EZ Plug connector (4-pin Molex Power connector) 1 x OC Station header (including 1 USB port) 1 x Go Button 1 x BIOS Switch button 1 x Audio front panel 1 x System panel connector</p>
Software	<p>Support DVD: - Drivers and Applications Sound Blaster X-Fi MB2 Utility ROG GameFirst Utility Kaspersky Anti-Virus ASUS TurboV EVO Utility ASUS PC Probe II ASUS Update ASUS AI Suite II</p>
Form Factor	ATX Form Factor, 12"x 9.6" (30.5cm x 24.4cm)

*Specifications are subject to change without notice.

This chapter describes the motherboard features and the new technologies it supports.

1 Product introduction

Chapter summary

1

1.1	Welcome!	1-1
1.2	Package contents.....	1-1
1.3	Special features.....	1-2

1.1 Welcome!

Thank you for buying an ROG Rampage III Formula motherboard!

The motherboard delivers a host of new features and latest technologies, making it another standout in the long line of ASUS quality motherboards!

Before you start installing the motherboard, and hardware devices on it, check the items in your package with the list below.

1.2 Package contents

Check your motherboard package for the following items.

Motherboard	ROG Rampage III Formula
Cables	1 x ROG Connect cable 1 x 3-Way SLI Bridge 1 x SLI Cable 3 x 2-in-1 SATA 3.0 Gb/s cables 1 x 2-in-1 SATA 6.0 Gb/s cables 1 x CrossFire cable
Accessories	1 x 2 in 1 ASUS Q-Connector Kit 1 x I/O Shield 1 x Cable Ties Pack 1 x Optional Fan 1 x 12-in-1 ROG Cable Label
Application DVD	ROG motherboard support DVD
Documentation	User guide



- If any of the above items is damaged or missing, contact your retailer.
- The item illustrations in above table are for reference only. Actual product specifications may vary with different models.

1.3 Special features

1.3.1 Product highlights

Republic of Gamers



The Republic of Gamers consists only the best of the best. We offer the best hardware engineering, the fastest performance, the most innovating ideas, and we welcome the best gamers to join in. In the Republic of Gamers, mercy rules are only for the weak, and bragging rights means everything. We believe in making statements and we excel in competitions. If your character matches our trait, then join the elite club, make your presence felt, in the Republic of Gamers.

Green ASUS



This motherboard and its packaging comply with the European Union's Restriction on the use of Hazardous Substances (RoHS). This is in line with the ASUS vision of creating environment-friendly and recyclable products/packaging to safeguard consumers' health while minimizing the impact on the environment.

LGA1366 Intel® Core™ i7 Ready



This motherboard supports the latest Intel® Core™ i7 processors in LGA1366 package with integrated memory controller to support 3-channel (6 DIMMs) DDR3 memory. Supports Intel® QuickPath Interconnect (QPI) with a system bus of up to 6.4 GT/s and a max bandwidth of up to 25.6 GB/s. Intel® Core™ i7 processor is one of the most powerful and energy efficient CPUs in the world.

Intel® X58 Chipset



The Intel® X58 Express Chipset is one of the most powerful chipset designed to support the Intel® Core™ i7 Processors with LGA1366 package and Intel® next generation system interconnect interface, Intel® QuickPath Interconnect (QPI), providing improved performance by utilizing serial point-to-point links, allowing increased bandwidth and stability. It also supports up to 36 PCI Express 2.0 lanes providing better graphics performance.

SLI/CrossFireX On-Demand



Why choose when you can have both?

SLI or CrossFireX? Fret no longer because with the ROG Rampage III Formula, you'll be able to run both multi-GPU setups. The board features SLI/CrossFireX on Demand technology, supporting SLI or CrossFireX configuration. Whichever path you take, you can be assured of jaw-dropping graphics at a level previously unseen.

Tri-Channel, DDR3 2200(O.C.) MHz

The motherboard supports DDR3 memory that features data transfer rates of 2200(O.C.)/2133(O.C.)/2000(O.C.)/1800(O.C.)/1600/1333/1066 MHz to meet the higher bandwidth requirements of the latest operation system, 3D graphics, multimedia, and Internet applications. The dual-channel DDR3 architecture double the bandwidth of your system memory to boost system performance.

PCIe 2.0

Double Speed; Double Bandwidth

This motherboard supports the latest PCIe 2.0 devices for double speed and bandwidth which enhances system performance.

1.3.2 ROG Intelligent Performance & Overclocking features

ROG Connect

Plug and Overclock - Tweak it the hardcore way!

Monitor the status of your desktop PC and tweak its parameters in real-time via a notebook—just like a race car engineer—with ROG Connect. ROG Connect links your main system to a notebook through a USB cable, allowing you to view real-time POST code and hardware status readouts on your notebook, as well as make on-the-fly parameter adjustments at a purely hardware level. Diagram, power, reset button, flash BIOS through notebook.

GameFirst

The speed you need to pwn

Low Internet latency allows you to frag more, and get fragged less. That's why ROG has introduced GameFirst, a feature that manages the flow of traffic according to your needs so that you can still listen to online music, download and upload files, and engage in Internet chats without sacrificing the low ping times you need to pwn your opponents.

Extreme Engine Digi+



Powerful combination of analog and digital design elements

Extreme Engine Digi+ equipped with high performance digital VRM design can easily achieve the ultimate performance with adjustable CPU PWM frequency. It expedites heat dissipation and achieves better electric conduction keeping critical components reliable. Now you'll be able to push your spanking new Intel CPU to the limit, hitting benchmark scores that others only dream of. Extreme Engine Digi+ balances the need for voltage and the desire for rock solid performance to bring the ultimate user experience.

MemOK!



Any memory is A-OK!

Memory compatibility is among the top concerns when it comes to computer upgrades. Worry no more, MemOK! is the fastest memory booting solution today. This remarkable memory rescue tool requires nothing but a push of a button to patch memory issues and get your system up and running in no time. The technology is able to determine failsafe settings that can dramatically improve system booting success.

iROG



Intelligent multiple control at hand

The iROG is a special IC which enables several ROG highlighted functions that gives users full disposal of the motherboard at any stage! This design allows advanced user control and management to be processed purely at a hardware level. iROG greatly increases fun during overclocking for PC enthusiasts and it offers system maintenance and management with more control and efficiency.

Probelt



Get all hands-on with hardware-based overclocking

Probelt takes the guesswork out of locating the motherboard's measurement points, identifying them clearly in the form of 8 sets of detection points so you'll know exactly where to get quick yet accurate readings using a multimeter.

BIOS Flashback

Two BIOS ROM. Two BIOS settings. Twice the overclocking flexibility.

Overclocker's prayer to have BIOS flexibility is answered! With the new BIOS Flashback, PC enthusiasts can overclock with even more confidence. BIOS Flashback gives overclockers the ability to save two versions of the BIOS simultaneously. Very much like the "SaveGame" function, one BIOS can be used for the overclocking adventure, while the other BIOS is to be stored with any previous version. BIOS Flashback brings the ultimate convenience to overclockers! By pushing BIOS button, overclockers can easily choose which BIOS ROM they want to save & boot from.

CPU Level Up

A simple click for instant upgrade!

Ever wish that you could have a more expansive CPU? Upgrade your CPU at no additional cost with ROG's CPU Level Up! Simply pick the processor you wanted to OC to, and the motherboard will do the rest! See the new CPU speed and enjoy that performance instantly. Overclocking is never as easy as this.

Extreme Tweaker

One stop performance tuning shop

Extreme Tweakers is the one stop shop to fine-tune your system to optimal performance. No matter if you're looking for frequency adjustment, over-voltage options, or memory timing settings, they're all here!

Voltiminder LED

Friendly reminder on Voltage Settings

In the pursuit of extreme performance, overvoltage adjustment is critical but risky. Acting as the "red zone" of a tachometer, the Voltiminder LED displays the voltage status for CPU, IOH/ICH, and Memory in a intuitive color-coded fashion. The voltiminder LED allows quick voltage monitoring for overclockers.

1.3.3 ROG unique features

COP EX

Maximum OC with confidence with burn proof protection to chipsets and GPU!

The COP EX allows overclockers to increase chipset voltage without the worries of overheating. It can also be used to monitor and save an overheating GPU. The COP EX allows more freedom and less constraint for maximum performance achievement.

Loadline Calibration

Optimal power boost for extreme CPU overclocking!

Maintaining ample voltage support for the CPU is critical during overclocking. The Loadline Calibration ensures stable and optimal CPU voltage under heavy loading. It helps overclockers enjoy the motherboard's ultimate OC capabilities and benchmark scores.

Onboard Switches

No more shorting pins or moving jumpers

With an easy press during overclock, this exclusive onboard switch allows gamer to effortlessly fine-tune the performance without having to short the pins or moving jumpers!

ASUS Q-Connector

Make connections quick and accurate

The Q-Connector allows you to connect or disconnect chassis front panel cables in one easy step with one complete module. This unique adapter eliminates the trouble of plugging in one cable at a time, making connection quick and accurate.

SupremeFX X-Fi 2

Play with ultra-real cinematic in-game surround sound!

SupremeFX X-Fi 2 delivers incredible gaming audio experiences to ROG die hards. It features hardware-accelerated EAX 5.0 and OpenAL for ultra-real cinematic in-game audio. It even comes with THX branding, which makes games, music and movies sound way better! SupremeFX X-Fi 2 also implements gold-plated jacks and high quality capacitors to ensure high definition adventures in audio.

1.3.4 ASUS special features

USB 3.0 Support



10X Faster Data Rates!

Experience ultra-fast data transfers at 4.8Gbps with USB 3.0—the latest connectivity standard. Built to connect easily with next generation components and peripherals, USB 3.0 transfers data 10X faster and is also backward compatible with USB 2.0 components.

SATA 6Gb/s Support



Experience the Future of Storage!

Supporting next-generation Serial ATA (SATA) storage interface, this motherboard delivers up to 6.0Gb/s data transfer rates. Additionally, get enhanced scalability, faster data retrieval, double the bandwidth of current bus systems.

O.C. Profile



Conveniently store or load multiple BIOS settings

Freely share and distribute favorite overclocking settings The motherboard features the ASUS O.C. Profile that allows users to conveniently store or load multiple BIOS settings. The BIOS settings can be stored in the CMOS or a separate file, giving users freedom to share and distribute their favorite overclocking settings.

8-channel Audio



Enjoy High-End 8-channel sound system on your PC

The onboard 8-channel HD audio (High Definition Audio, previously code-named Azalia) CODEC enables high-quality 192KHz/24-bit audio output, jack-sensing feature, retasking functions and multi-streaming technology that simultaneously sends different audio streams to different destinations. This motherboard now adopts the future standard to deliver the most vivid audio enjoyment.

Kaspersky® Anti-Virus



The best protection from viruses and spyware

Kaspersky® Anti-Virus Personal offers premium antivirus protection for individual users and home offices. It is based on advanced antivirus technologies. The product incorporates the Kaspersky® Anti-Virus engine, which is renowned for malicious program detection rates that are among the industry's highest.

This chapter lists the hardware setup procedures that you have to perform when installing system components. It includes description of the jumpers and connectors on the motherboard.

Hardware 2 information

2.1	Before you proceed	2-1
2.2	Motherboard overview.....	2-6
2.3	Central Processing Unit (CPU)	2-9
2.4	System memory	2-14
2.5	Expansion slots.....	2-26
2.6	Jumper	2-30
2.7	I/O shield Installation	2-32
2.8	Connectors	2-33
2.9	Starting up for the first time.....	2-52
2.10	Turning off the computer.....	2-53

2.1 Before you proceed

Take note of the following precautions before you install motherboard components or change any motherboard settings.



-
- Unplug the power cord from the wall socket before touching any component.
 - Before handling components, use a grounded wrist strap or touch a safely grounded object or a metal object, such as the power supply case, to avoid damaging them due to static electricity.
 - Hold components by the edges to avoid touching the ICs on them.
 - Whenever you uninstall any component, place it on a grounded antistatic pad or in the bag that came with the component.
 - Before you install or remove any component, ensure that the ATX power supply is switched off or the power cord is detached from the power supply. Failure to do so may cause severe damage to the motherboard, peripherals, or components.
-

Onboard LEDs

The motherboard comes with a set of LEDs that indicate the voltage conditions of CPU, memory, northbridge and southbridge. You may adjust the voltages in BIOS. There are also an LED for hard disk drive activity and an onboard switch for power status. For more information about voltage adjustment, refer to **3.3 Extreme Tweaker menu**.

1. CPU LED

The CPU LED has three voltage displays: CPU Voltage, CPU PLL, and QPI/DRAM Voltage; you can select the voltage to display in BIOS. Refer to the illustration below for the location of the CPU LED and the table below for LED definition.

2. Memory LED

Refer to the illustration below for the location of the memory LED and the table below for LED definition.

3. Northbridge/Southbridge LEDs

Northbridge and southbridge LEDs each have two different voltage displays. The northbridge LED displays either IOH voltage or the IOH PCIE voltage. The southbridge LED shows either the ICH voltage or the ICH PCIE voltage. You can select the voltage to display in BIOS. Refer to the illustration below for the location of the northbridge/southbridge LEDs and the table below for LED definition.

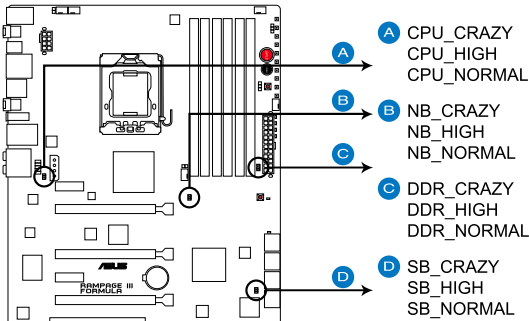

RAMPAGE III FORMULA CPU/ NB/ DDR/ SB LED

	Normal (green)	High (yellow)	Crazy (red)
CPU Voltage (default)	0.85–1.5	1.50625–1.59375	1.6–
CPU PLL	1.20575–1.89475	1.90800–1.94775	1.96100–
QPI/DRAM	1.2–1.39375	1.4–1.69375	1.7–

	Normal (green)	High (yellow)	Crazy (red)
DRAM Bus Voltage	1.20575–1.60325	1.61650–1.802	1.81525–

	Normal (green)	High (yellow)	Crazy (red)
IOH (default)	1.11300–1.39125	1.40450–1.64300	1.65625–
IOH PCIE	1.51050–1.69600	1.70925–1.84175	1.85500–
ICH	1.11300–1.59000	1.60325–1.84175	1.85500–
ICH PCIE	1.51050–1.61650	1.62975–1.80200	1.81525–

4. Hard Disk LED

The hard disk LED is designed to indicate the hard disk activity. It blinks when data is being written into or read from the hard disk drive. The LED does not light up when there is no hard disk drive connected to the motherboard or when the hard disk drive does not function.

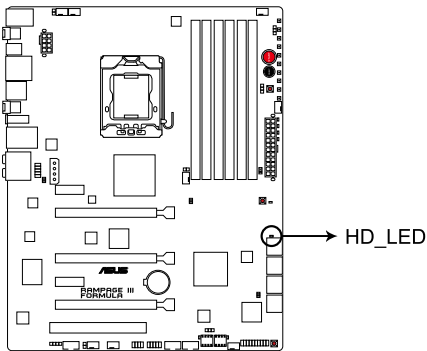

RAMPAGE III FORMULA Hard Disk LED

5. BIOS LED

The BIOS LEDs help indicate the BIOS activity. Press the BIOS button to switch between BIOS1 and BIOS2 and the LED lights up when the corresponding BIOS is in use.

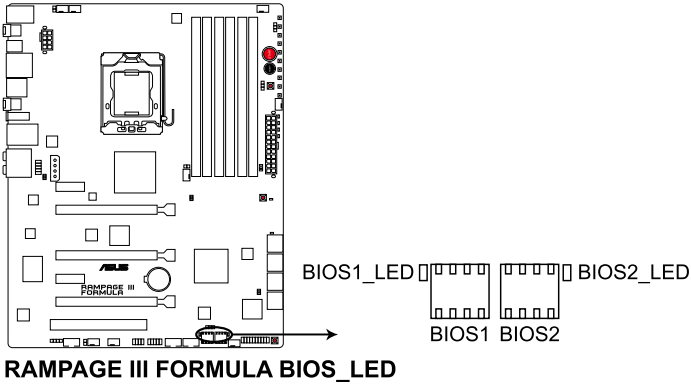

6. GO LED

Blinking: Indicates that MemOK! is enabled before POST.

Lighting: Indicates that the system loads the preset profile (GO_Button file) for temporary overlocking when in OS.

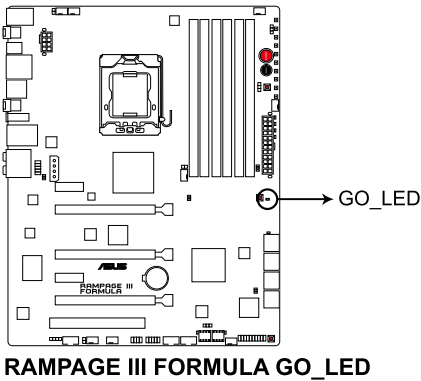

7. Q LED

Q LEDs check key components (CPU, DRAM, VGA card, and booting devices) in sequence during motherboard booting process. If an error is found, the corresponding LED will continue lighting until the problem is solved. This user-friendly design provides an intuitive way to locate the root problem within a second.

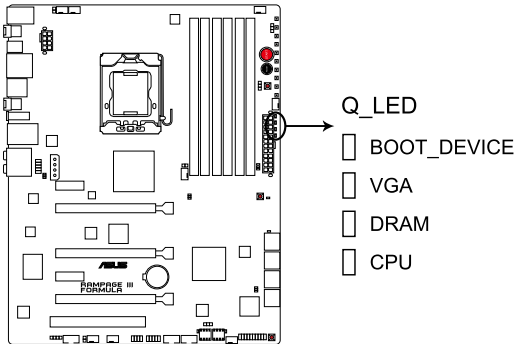

**RAMPAGE III FORMULA CPU/ DRAM/
VGA/ BOOT_DEVICE LED**

8. Power LED

The motherboard comes with a power-on switch that lights up to indicate that the system is ON, in sleep mode, or in soft-off mode. This is a reminder that you should shut down the system and unplug the power cable before removing or plugging in any motherboard component. The illustration below shows the location of the onboard power-on switch.

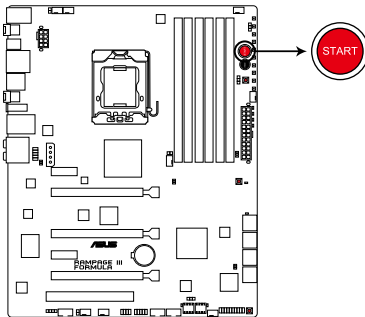

RAMPAGE III FORMULA Power on switch

2.2 Motherboard overview

2.2.1 Motherboard layout

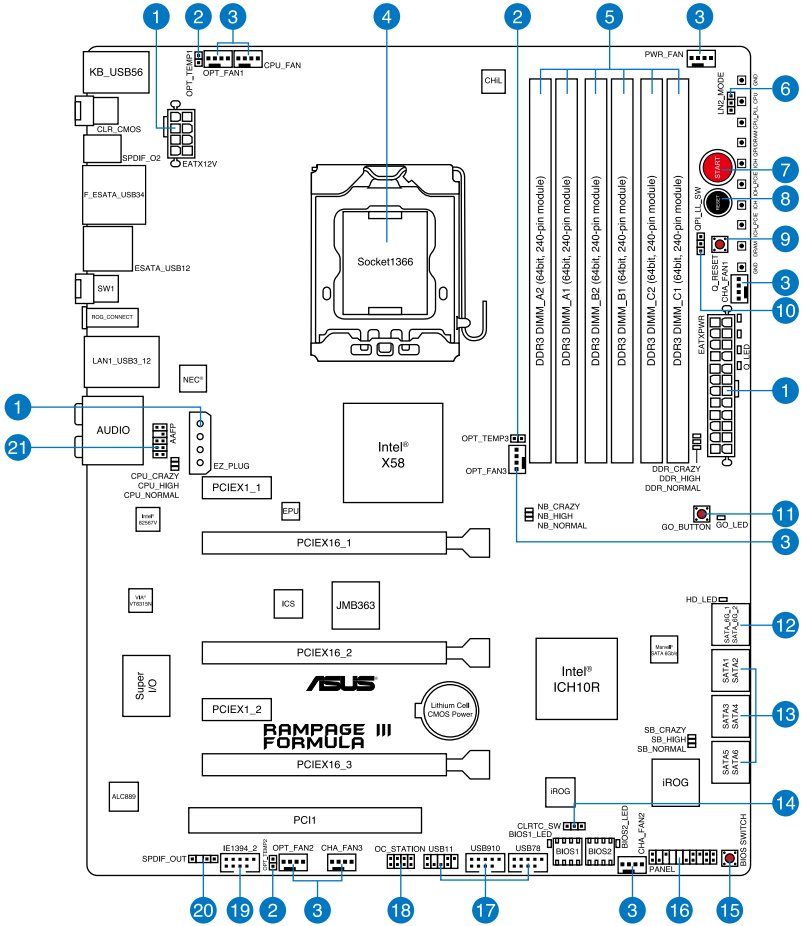

2.2.2 Layout contents

Connectors/Jumpers/Switches/Slots		Page
1.	ATX power connectors (24-pin EATXPWR, 8-pin EATX12V, 4-pin EZ_PLUG1—2)	2-45
2.	Thermal sensor cable connectors (2-pin OPT_TEMP1—3)	2-43
3.	CPU, chassis, and optional fan connectors (4-pin CPU_FAN; 4-pin PWR_FAN; 4-pin CHA_FAN1—3; 4-pin OPT_FAN1—3)	2-42
4.	LGA1366 CPU Socket	2-9
5.	DDR3 DIMM slots	2-14
6.	LN2 Mode jumper (3-pin LN2)	2-31
7.	Power-on switch	2-48
8.	Reset switch	2-48
9.	Q reset button	2-50
10.	QPI_LL (3-pin QPI_LL_SW)	2-31
11.	GO button	2-49
12.	Marvell® Serial ATA 6.0 Gb/s connectors (7-pin SATA_6G_1/2 [red])	2-39
13.	ICH10R Serial ATA connectors (7-pin SATA 1-6 [grey])	2-38
14.	Clear RTC RAM (3-pin CLRTC_SW)	2-30
15.	BIOS switch	2-49
16.	System panel connector (20-8 pin PANEL)	2-46
17.	USB connector (10-1 pin USB78, USB910, USB11)	2-40
18.	OC Station connector (8-pin OC_STATION)	2-40
19.	IEEE 1394a port connector (10-1 pin IE1394_2)	2-41
20.	Digital audio connector (4-1 pin SPDIF_OUT)	2-43
21.	Front panel audio connector (10-1 pin AAFP)	2-44



Refer to **2.9 Connectors** for more information about rear panel connectors and internal connectors.

2.2.3 Placement direction

When installing the motherboard, ensure that you place it into the chassis in the correct orientation. The edge with external ports goes to the rear part of the chassis as indicated in the image below.

2.2.4 Screw holes

Place nine (9) screws into the holes indicated by circles to secure the motherboard to the chassis.



DO NOT overtighten the screws! Doing so can damage the motherboard.

Place this side towards the rear of the chassis

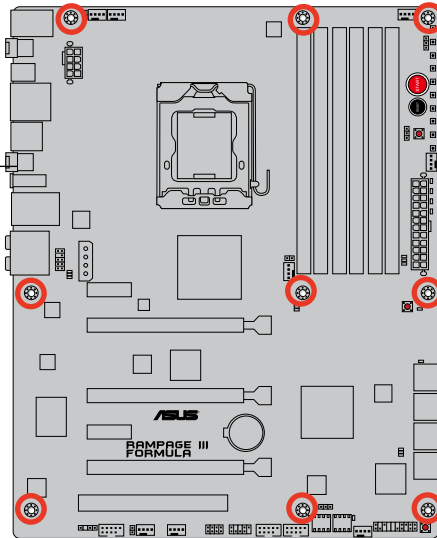

2.3 Central Processing Unit (CPU)

The motherboard comes with a surface mount LGA1366 socket designed for the Intel® Core™ i7 Processors.



Ensure that all power cables are unplugged before installing the CPU.



- Upon purchase of the motherboard, ensure that the PnP cap is on the socket and the socket contacts are not bent. Contact your retailer immediately if the PnP cap is missing, or if you see any damage to the PnP cap/socket contacts/motherboard components. ASUS will shoulder the cost of repair only if the damage is shipment/transit-related.
- Keep the cap after installing the motherboard. ASUS will process Return Merchandise Authorization (RMA) requests only if the motherboard comes with the cap on the LGA1366 socket.
- The product warranty does not cover damage to the socket contacts resulting from incorrect CPU installation/removal, or misplacement/loss/incorrect removal of the PnP cap.

2.3.1 Installing the CPU

To install a CPU:

1. Locate the CPU socket on the motherboard.

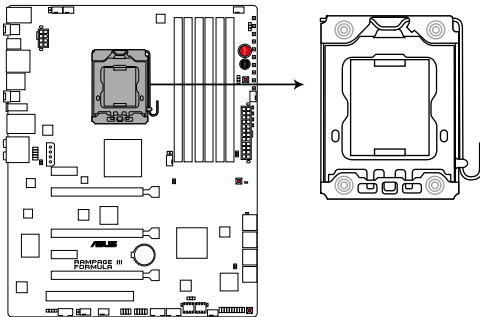

RAMPAGE III FORMULA CPU LGA1366

2. Press the load lever with your thumb (A), then move it to the left (B) until it is released from the retention tab.



To prevent damage to the socket pins, do not remove the PnP cap unless you are installing a CPU.

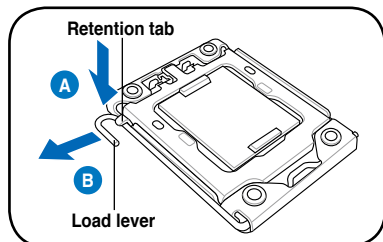

3. Lift the load lever in the direction of the arrow to a 135° angle.
4. Lift the load plate with your thumb and forefinger to a 100° angle.

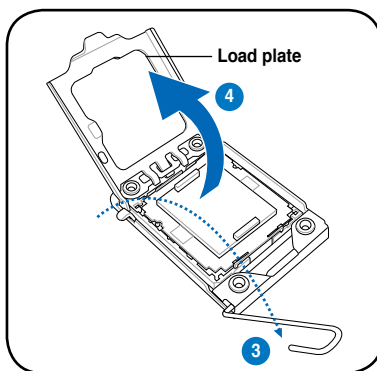

5. Remove the PnP cap from the CPU socket.

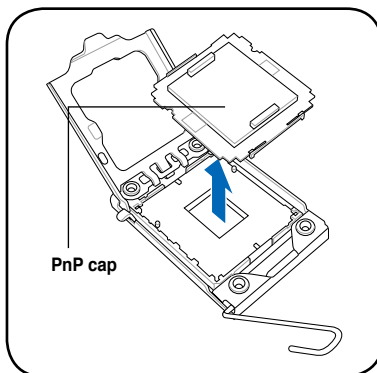

- Position the CPU over the socket, ensuring that the gold triangle is on the bottom-left corner of the socket, and then fit the socket alignment key into the CPU notch.



The CPU fits in only one correct orientation. DO NOT force the CPU into the socket to prevent bending the connectors on the socket and damaging the CPU!

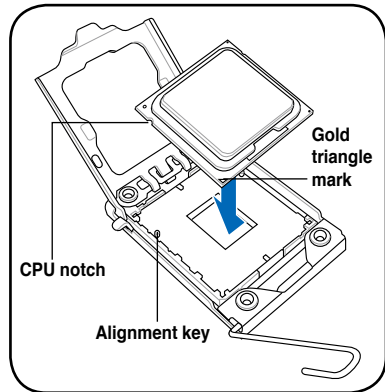

- Apply some Thermal Interface Material to the exposed area of the CPU that the heatsink will be in contact with, ensuring that it is spread in an even thin layer.



Some heatsinks come with pre-applied Thermal Interface Material. If so, skip this step.

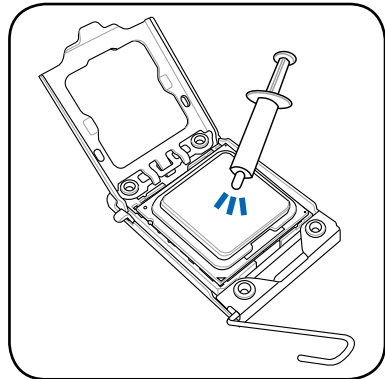

The Thermal Interface Material is toxic. DO NOT eat the Thermal Interface Material. If it gets into your eyes or touches your skin, ensure that you wash it off immediately and seek professional medical help.



To prevent contaminating the Thermal Interface Material, DO NOT spread the Thermal Interface Material with your finger directly.

2.3.2 Installing the CPU heatsink and fan

The Intel® LGA1366 processor requires a specially designed heatsink and fan assembly to ensure optimum thermal condition and performance.



- When you buy a boxed Intel® processor, the package includes the CPU fan and heatsink assembly. If you buy a CPU separately, ensure that you use only Intel®-certified multi-directional heatsink and fan.
- Your Intel® LGA1366 heatsink and fan assembly comes in a push-pin design and requires no tool to install.
- Use an LGA1366-compatible CPU heatsink and fan assembly only. The LGA1366 socket is incompatible with the LGA775 and LGA1366 sockets in size and dimension.



If you purchased a separate CPU heatsink and fan assembly, ensure that the Thermal Interface Material is properly applied to the CPU heatsink or CPU before you install the heatsink and fan assembly.



Ensure that you have installed the motherboard to the chassis before you install the CPU fan and heatsink assembly.

To install the CPU heatsink and fan:

1. Place the heatsink on top of the installed CPU, ensuring that the four fasteners match the holes on the motherboard.
2. Push down two fasteners at a time in a diagonal sequence to secure the heatsink and fan assembly in place.

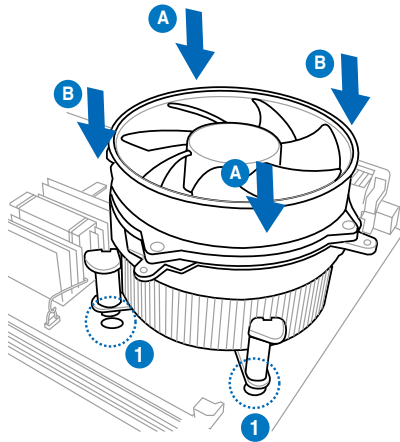
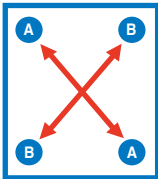

Orient the heatsink and fan assembly such that the CPU fan cable is closest to the CPU fan connector.

3. Connect the CPU fan cable to the connector on the motherboard labeled CPU_FAN.

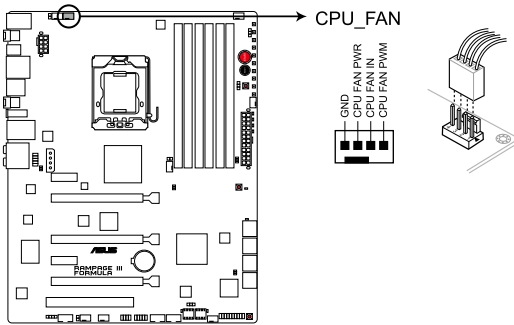

RAMPAGE III FORMULA CPU fan connector



DO NOT forget to connect the CPU fan connector! Hardware monitoring errors can occur if you fail to plug this connector.

2.3.3 Uninstalling the CPU heatsink and fan

To uninstall the CPU heatsink and fan:

1. Disconnect the CPU fan cable from the connector on the motherboard.
2. Rotate each fastener counterclockwise.
3. Pull up two fasteners at a time in a diagonal sequence to disengage the heatsink and fan assembly from the motherboard.

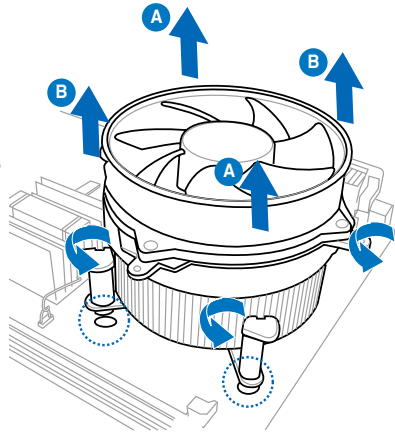
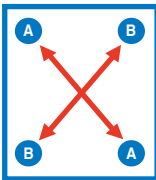

4. Carefully remove the heatsink and fan assembly from the motherboard.

2.4 System memory

2.4.1 Overview

The motherboard comes with six Double Data Rate 3 (DDR3) Dual Inline Memory Modules (DIMM) sockets.

A DDR3 module has the same physical dimensions as a DDR2 DIMM but is notched differently to prevent installation on a DDR2 DIMM socket. DDR3 modules are developed for better performance with less power consumption.

The figure illustrates the location of the DDR3 DIMM sockets:

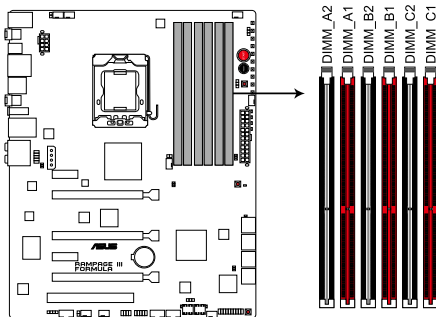

RAMPAGE III FORMULA 240-pin DDR3 DIMM sockets

2.4.2 Memory configurations

You may install 512MB, 1GB, 2GB and 4GB unbuffered and non-ECC DDR3 DIMMs into the DIMM sockets.



-
- You may install varying memory sizes in Channel A, Channel B and Channel C. The system maps the total size of the lower-sized channel for the dual-channel or triple-channel configuration. Any excess memory from the higher-sized channel is then mapped for single-channel operation.
 - Due to Intel spec definition, X.M.P. DIMMs and DDR3-1600 are supported for one DIMM per channel only.
 - According to Intel CPU spec, DIMMs with voltage requirement over 1.65V may damage the CPU permanently. We recommend you install the DIMMs with the voltage requirement below 1.65V.
 - Always install DIMMs with the same CAS latency. For optimum compatibility, we recommend that you obtain memory modules from the same vendor.
 - Due to the memory address limitation on 32-bit Windows OS, when you install 4GB or more memory on the motherboard, the actual usable memory for the OS can be about 3GB or less. For effective use of memory, we recommend that you do any of the following:
 - Use a maximum of 3GB system memory if you are using a 32-bit Windows OS.
 - Install a 64-bit Windows OS when you want to install 4GB or more on the motherboard.For more details, refer to the Microsoft® support site at <http://support.microsoft.com/kb/929605/en-us>.
 - This motherboard does not support DIMMs made up of 512 Mb (64MB) chips or less (Memory chip capacity counts in Megabit, 8 Megabit/Mb = 1 Megabyte/MB).
-



-
- The default memory operation frequency is dependent on its Serial Presence Detect (SPD), which is the standard way of accessing information from a memory module. Under the default state, some memory modules for overclocking may operate at a lower frequency than the vendor-marked value. To operate at the vendor-marked or at a higher frequency, refer to section **3.3 Extreme Tweaker** menu for manual memory frequency adjustment.
 - For system stability, use a more efficient memory cooling system to support a full memory load (6 DIMMs) or overclocking condition.
-

Rampage III Formula Motherboard Qualified Vendors Lists (QVL) DDR3-2400MHz capability

Vendors	Part No.	Size	SS/DS	Timing	Voltage	DIMM socket support (Optional)			
						2 DIMM	3 DIMM	5 DIMM	6 DIMM
CORSAIR	CMGTX3(XMP)	2GB	DS	9-11-9-27	1.65	•			
G.SKILL	F3-19200CL9D-4GBPIS(XMP)	4G (2x 2G)	DS	9-11-11-31	1.65				
G.SKILL	F3-19200CL9D-4GBPIS(XMP)	4G (2x 2G)	DS	9-11-9-28	1.65	•			

Rampage III Formula Motherboard Qualified Vendors Lists (QVL) DDR3-2200MHz capability

Vendors	Part No.	Size	SS/DS	Timing	Voltage	DIMM socket support (Optional)			
						2 DIMM	3 DIMM	4 DIMM	6 DIMM
G.SKILL	F3-17600CL7D-4GBFLS(XMP)	4G (2x 2G)	DS	7-10-10-28	1.65	•	•	•	
G.SKILL	F3-17600CL8D-4GBPS(XMP)	4GB(2 x 2GB)	DS	8-8-8-24	1.65				
G.SKILL	F3-17600CL9D-4GBTDS(XMP)	4GB(2 x 2GB)	DS	9-9-9-24	1.65				
KINGMAX	FLKE85F-B8KHA(XMP)	4G (2x 2G)	DS	-	1.5-1.7				

Rampage III Formula Motherboard Qualified Vendors Lists (QVL) DDR3-2133MHz capability

Vendors	Part No.	Size	SS/DS	Timing	Voltage	DIMM socket support (Optional)			
						2 DIMM	3 DIMM	4 DIMM	6 DIMM
G.SKILL	F3-17066CL9D-4GBTDS(XMP)	4GB (2x 2GB)	DS	-	1.65				
G.SKILL	F3-17066CL8D-4GBPS(XMP)	4GB(2 x 2GB)	DS	8-8-8-24	1.65	•			
G.SKILL	F3-17066CL9D-4GBTD(XMP)	4GB(2 x 2GB)	DS	9-9-9-24	1.65	•			
G.SKILL	F3-17066CL9T-6GB-T	6GB(3 x 2GB)	DS	9-9-9-24	1.65	•			
GEIL	GE34GB2133C9DC(XMP)	4GB(2 x 2GB)	DS	9-9-9-28	1.65				
GEIL	GU34GB2133C9DC(XMP)	4GB(2 x 2GB)	DS	9-9-9-28	1.65				
KINGSTON	KHX2133C8D3T1K2/4GX(XMP)	4GB(2 x 2GB)	DS	8	1.65				
KINGSTON	KHX2133C9D3T1K2/4GX(XMP)	4GB(2 x 2GB)	DS	9	1.65				

Rampage III Formula Motherboard Qualified Vendors Lists (QVL) DDR3-2000MHz capability

Vendor	Part No.	Size	SS/DS	Timing	Voltage	DIMM socket support (Optional)			
						2 DIMM	3 DIMM	4 DIMM	6 DIMM
Apacer	78.AAGD5.9KD(XMP)	6GB(3 x 2GB)	DS	9-9-9-27	-	•	•	•	•
CORSAIR	CMG4GX3M2A2000C8(XMP)	4GB(2 x 2GB)	DS	8-8-8-24	1.65				
CORSAIR	CMT6GX3M3A2000C8(XMP)	6GB (3x 2GB)	DS	8-9-8-24	1.65	•		•	
Crucial	BL12864BE2009.8SFB3(EPP)	1GB	SS	9-9-9-28	2	•	•	•	
G.SKILL	F3-16000CL9Q-4GBRH(XMP)	4GB (4x 1GB)	SS	9-9-9-27	1.6				
G.SKILL	F3-16000CL6Q-8GBPI(XMP)	8GB (4x 2GB)	SS	6-9-6-24	1.65	•			
G.SKILL	F3-16000CL9D-4GBRH(XMP)	4GB(2 x 2GB)	DS	9-9-9-24	1.65				
G.SKILL	F3-16000CL9D-4GBTD(XMP)	4GB(2 x 2GB)	DS	9-9-9-24	1.65	•	•		
G.SKILL	F3-16000CL7T-6GBPS(XMP)	6GB(3 x 2GB)	DS	7-8-7-20	1.65	•			
G.SKILL	F3-16000CL9T-6GBPS(XMP)	6GB(3 x 2GB)	DS	9-9-9-24	1.65	•	•		
G.SKILL	F3-16000CL9T-6GBTD(XMP)	6GB(3 x 2GB)	DS	9-9-9-24	1.6	•			
G.SKILL	F3-16000CL7Q-8GBFLS(XMP)	8GB(4 x 2GB)	DS	7-9-7-24	1.65		•	•	
GEIL	GU34GB2000C9DC(XMP)	4GB(2 x 2GB)	DS	9-9-9-28	2	•	•	•	
GEIL	GU34GB2000C9DC(XMP)	4GB(2 x 2GB)	DS	9-9-9-28	1.65				
GEIL	GE38GB2000C9QC(XMP)	8GB(4 x 2GB)	DS	9-9-9-28	1.65	•			
KINGSTON	KHX2000C9AD3T1K2/4GX(XMP)	4GB (2x 2GB)	DS	9	1.65	•	•	•	•
OCZ	OCZ3FXT20002GK	2GB(2 x 1GB)	SS	8	1.9				
OCZ	OCZ3P20002GK(EPP)	2GB(2 x 1GB)	SS	9	1.9	•			
OCZ	OCZ3P2000EB2GK	2GB(2 x 1GB)	SS	9-8-8	1.8				
OCZ	OCZ3G2000LV6GK	6GB (3x 2GB)	DS	-	1.65				
OCZ	OCZ3B2000LV6GK	6GB(3 x 2GB)	DS	7-8-7	1.65	•			
OCZ	OCZ3G2000LV6GK	6GB(3 x 2GB)	DS	7-8-7	1.65	•	•		
Transcend	TX2000KLU-4GK(XMP)	4GB(2 x 2GB)	DS	9-9-9-24	1.65				
Gingle	9CAASS37AZZ01D1	2GB	DS	9-9-9-24	-	•	•	•	
Patriot	PVS32G2000LLKN	2GB(2 x 1GB)	SS	9-9-9-24	2		•		
Patriot	PVT36G2000LLK(XMP)	6GB(3 x 2GB)	DS	8-8-8-24	1.65	•	•	•	
Silicon Power	SP002GBLYU200S02(XMP)	2GB	DS	-	-	•	•	•	•

Rampage III Formula Motherboard Qualified Vendors Lists (QVL) DDR3-1866MHz capability

Vendors	Part No.	Size	SS/DS	Timing	Voltage	DIMM socket support (Optional)			
						2 DIMM	3 DIMM	4 DIMM	6 DIMM
CORSAIR	CMT6GX3M3A1866C9(XMP)	6GB (3x 2GB)	DS	9-9-9-24	1.65	•	•	•	•
CORSAIR	TR3X6G1866C9DVer4.1(XMP)	6GB(3 x 2GB)	DS	9-9-9-24	1.65	•			
G.SKILL	F3-15000CL9D-4GBRH (XMP)	4GB(2 x 2GB)	DS	9-9-9-24	1.65				
G.SKILL	F3-15000CL9D-4GBTD(XMP)	4GB(2 x 2GB)	DS	9-9-9-24	1.65	•	•	•	
KINGSTON	KHX1866C9D3T1K3/6GX(XMP)	6GB(3 x 2GB)	DS	9	1.65	•	•	•	
OCZ	OCZ3RPR1866C9LV3GK	3GB(3 x 1GB)	SS	9-9-9	1.65		•		
OCZ	OCZ3P1866LV4GK	4GB(2 x 2GB)	DS	9-9-9	1.65	•	•	•	
OCZ	OCZ3P1866C9LV6GK	6GB(3 x 2GB)	DS	9-9-9	1.65	•	•	•	••
OCZ	OCZ3RPR1866C9LV6GK	6GB(3 x 2GB)	DS	9-9-9	1.65	•	•		
Super Talent	W1866UX2G8(XMP)	2GB(2 x 1GB)	SS	8-8-8-24	-	•			
Patriot	PVS32G1866LLK(XMP)	2GB(2 x 1GB)	SS	8-8-8-24	1.9	•			
Patriot	PVS32G1866LLK(XMP)	2GB(2 x 1GB)	SS	8-8-8-24	1.9	•			

Rampage III Formula Motherboard Qualified Vendors Lists (QVL) DDR3-1800MHz capability

Vendors	Part No.	Size	SS/DS	Timing	Voltage	DIMM socket support (Optional)			
						2 DIMM	3 DIMM	4 DIMM	6 DIMM
G.SKILL	F3-14400CL6D-4GBFLS(XMP)	4GB(2 x 2GB)	DS	6-8-6-24	1.65	•	•	•	
G.SKILL	F3-14400CL9D-4GBRL(XMP)	4GB(2 x 2GB)	DS	9-9-9-24	1.6	•	•	•	
KINGSTON	KHX1800C9D3T1K3/6GX(XMP)	6GB(3 x 2GB)	DS	-	1.65	•	•	•	•
OCZ	OCZ3P18002GK	2GB(2 x 1GB)	SS	8	-	•	•		
OCZ	OCZ3P18002GK	2GB(2 x 1GB)	SS	8	-				
OCZ	OCZ3P18004GK	4GB(2 x 2GB)	DS	8	1.9	•	•	•	
Patriot	PVS32G1800LLKN(EPP)	2GB(2 x 1GB)	SS	8-8-8-20	1.9	•	•	•	

Rampage III Formula Motherboard

Qualified Vendors Lists (QVL) DDR3-1600MHz capability

Vendors	Part No.	Size	SS/ DS	Timing	Voltage	DIMM socket support (Optional)			
						2 DIMM	3 DIMM	4 DIMM	6 DIMM
A-DATA	AX3U1600GB2G9-2G	4GB (2x 2GB)	DS	9-9-9-24	1.55-1.75				
A-DATA	AX3U1600GC4G9-2G	8GB (2x 4GB)	DS	9-9-9-24	1.55-1.75				
CORSAIR	TR3X3G1600C8DVer2.1(XMP)	3GB(3 x 1GB)	SS	8-8-8-24	1.65	•	•	•	•
CORSAIR	TR3X3G1600C9Ver1.1(XMP)	3GB(3 x 1GB)	SS	9-9-9-24	1.65	•	•		
CORSAIR	CMG4GX3M2A1600C6	4GB (2x 2GB)	DS	6-6-6-18	1.65	•	•	•	•
CORSAIR	CMD4GX3M2B1600C8	4GB(2x 2GB)	DS	8-8-8-24	1.65			•	
CORSAIR	CMG4GX3M2A1600C6	4GB(2x 2GB)	DS	6-6-6-18	1.65	•	•		
CORSAIR	CMX4GX3M2A1600C8(XMP)	4GB(2x 2GB)	DS	8-8-8-24	1.65	•	•	•	
CORSAIR	CMD4GX3M2A1600C8(XMP)	4GB(2 x 2GB)	DS	8-8-8-24	1.65	•	•		
CORSAIR	CMG4GX3M2A1600C7(XMP)	4GB(2 x 2GB)	DS	7-7-7-20	1.65	•	•		
CORSAIR	CMX4GX3M2A1600C9(XMP)	4GB(2 x 2GB)	DS	9-9-9-24	1.65	•	•	•	
CORSAIR	CMX6GX3M3A1600C9(XMP)	6GB (3x 2GB)	DS	9-9-9-24	1.65				
CORSAIR	TR3X6G1600C8D	6GB(3 x 2GB)	DS	8-8-8-24	1.65	•	•		
CORSAIR	TR3X6G1600C8DVer2.1(XMP)	6GB(3 x 2GB)	DS	8-8-8-24	1.65	•	•		
CORSAIR	TR3X6G1600C9Ver2.1(XMP)	6GB(3 x 2GB)	DS	9-9-9-24	1.65	•	•	•	•
CORSAIR	CMD8GX3M4A1600C8(XMP)	8GB(4 x 2GB)	DS	8-8-8-24	1.65				
CORSAIR	CMX8GX3M4A1600C9(XMP)	8GB(4 x 2GB)	DS	9-9-9-24	1.65	•	•		
Crucial	BL12864BN1608.8FF(XMP)	2GB(2x 1GB)	SS	8-8-8-24	1.65	•	•	•	•
Crucial	BL25664BN1608.16FF(XMP)	2GB	DS	8-8-8-24	1.65	•	•	•	•
Crucial	BL25664BN1608.16FF(XMP)	4GB(2x 2GB)	DS	8-8-8-24	1.65				
G.SKILL	F3-12800CL9D-2GBNQG	2GB(2 x 1GB)	SS	-	1.6				
G.SKILL	F3-12800CL9D-4GBNG	4GB(2x 2GB)	SS	-	1.6				
G.SKILL	F3-12800CL9D-4GBRL	4GB(2 x 2GB)	SS	-	1.6				
G.SKILL	F3-12800CL7D-4GBRM(XMP)	4GB(2x 2GB)	DS	7-8-7-24	1.6				
G.SKILL	F3-12800CL7D-4GBECO(XMP)	4GB(2 x 2GB)	DS	7-8-7-24	-	•	•		
G.SKILL	F3-12800CL7D-4GBRH(XMP)	4GB(2 x 2GB)	DS	7-7-7-24	1.65	•	•	•	•
G.SKILL	F3-12800CL8D-4GBRM(XMP)	4GB(2 x 2GB)	DS	8-8-8-24	1.6	•	•	•	•
G.SKILL	F3-12800CL9D-4GBECO(XMP)	4GB(2 x 2GB)	DS	9-9-9-24	1.35	•	•	•	•
G.SKILL	F3-12800CL8T-6GBP(XMP)	6GB(3 x 2GB)	DS	8-8-8-21	1.6~1.65	•	•	•	•
G.SKILL	F3-12800CL9T-6GBNQG	6GB(3 x 2GB)	DS	9-9-9-24	1.5-1.6	•	•	•	
GEIL	GE34GB1600C9DC(XMP)	4GB (2x 2GB)	DS	9-9-9-28	1.6	•			
GEIL	GE34GB1600C9DC(XMP)	4GB(2x 2GB)	DS	9-9-9-28	1.65				
GEIL	GV34GB1600C8DC(XMP)	4GB(2 x 2GB)	DS	8-8-8-28	1.6	•	•	•	
KINGMAX	FLGD45F-B8MF7(XMP)	1GB	SS		-	•	•	•	•
KINGMAX	FLGE85F-B8MF7(XMP)	2GB	DS		-				
KINGSTON	KHX1600C8D3K2/4GX(XMP)	4GB (2x 2GB)	DS	8	1.65	•	•	•	•
KINGSTON	KHX1600C8D3T1K2/4GX(XMP)	4GB (2x 2GB)	DS	8	1.65				
KINGSTON	KHX1600C9D3K3/6GX(XMP)	6GB (3x 2GB)	DS	9	1.65				
OCZ	OCZ3P1600EB1G	1GB	SS	7-6-6-24	-	•			

OCZ	OCZ3G1600LV3GK	3GB(3 x 1GB)	SS	8-8-8	1.65	*	*	*
OCZ	OCZ3P1600LV3GK	3GB(3 x 1GB)	SS	7-7-7	1.65	*	*	*
OCZ	OCZ3BE1600C8LV4GK	4GB(2x 2GB)	DS	8-8-8	1.65	*	*	*
OCZ	OCZ3BE1600C8LV4GK	4GB(2x 2GB)	DS	8-8-8	1.65	*	*	*
OCZ	OCZ3OB1600LV4GK	4GB(2x 2GB)	DS	9-9-9	1.65	*	*	*
OCZ	OCZ3P16004GK	4GB(2x 2GB)	DS	7-7-7	1.9	*	*	*
OCZ	OCZ3OB1600LV4GK	4GB(2 x 2GB)	DS	9-9-9	1.65	*	*	*
OCZ	OCZ3P1600EB4GK	4GB(2 x 2GB)	DS	7-7-6	1.8	*	*	*
OCZ	OCZ3P1600LV4GK	4GB(2 x 2GB)	DS	7-7-7	1.65	*	*	*
OCZ	OCZ3X16004GK(XMP)	4GB(2 x 2GB)	DS	7-7-7	1.9	*	*	*
OCZ	OCZ3X1600LV4GK(XMP)	4GB(2 x 2GB)	DS	8-8-8	1.65	*	*	*
OCZ	OCZ3FXE1600C7LV6GK	6GB (3x 2GB)	DS	7-7-7	1.65	*	*	*
OCZ	OCZ3FXE1600C7LV6GK	6GB(3 x 2GB)	DS	7-7-7	1.65	*	*	*
OCZ	OCZ3FXE1600C7LV6GK	6GB(3 x 2GB)	DS	7-7-7	1.65	*	*	*
OCZ	OCZ3G1600LV6GK	6GB(3 x 2GB)	DS	8-8-8	1.65	*	*	*
OCZ	OCZ3G1600LV6GK	6GB(3 x 2GB)	DS	8-8-8	1.65	*	*	*
OCZ	OCZ3X1600LV6GK(XMP)	6GB(3 x 2GB)	DS	8-8-8	1.65	*	*	*
OCZ	OCZ3X1600LV6GK(XMP)	6GB(3 x 2GB)	DS	8-8-8	1.65	*	*	*
Super Talent	WP160UX4G8(XMP)	4GB(2 x 2GB)	DS	8	-	*	*	*
Super Talent	WP160UX4G9(XMP)	4GB(2 x 2GB)	DS	9	-	*	*	*
Super Talent	WB160UX6G8(XMP)	6GB(3 x 2GB)	DS	-	-	*	*	*
Super Talent	WB160UX6G8(XMP)	6GB(3 x 2GB)	DS	8	-	*	*	*
Super Talent	WB160UX6G9(XMP)	6GB(3 x 2GB)	DS	9	-	*	*	*
EK Memory	EKM324L28BP8-116(XMP)	4GB(2x 2GB)	DS	9	-	*	*	*
EK Memory	EKM324L28BP8-116(XMP)	4GB(2 x 2GB)	DS	9	-	*	*	*
Elixir	M2Y2G64CB8HA9N-DG(XMP)	2GB	DS	-	-	*	*	*
GoodRam	GR1600D364L9/2G	2GB	DS	-	-	*	*	*
KINGTIGER	KTG2G1600PG3(XMP)	2GB	DS	-	-	*	*	*
Mushkin	996657	4GB(2 x 2GB)	DS	7-7-7-20	-	*	*	*
Mushkin	998659(XMP)	6GB(3 x 2GB)	DS	9-9-9-24	1.5-1.6	*	*	*
Patriot	PVT33G1600ELK	3GB(3 x 1GB)	SS	9-9-9-24	1.65	*	*	*
Patriot	PGS34G1600LLKA2	4GB (2x 2GB)	DS	8-8-8-24	1.7	*	*	*
Patriot	PVV34G1600LLK(XMP)	4GB (2x 2GB)	DS	8-8-8-24	1.65	*	*	*
Patriot	PGS34G1600LLKA	4GB(2x 2GB)	DS	7-7-7-20	1.7	*	*	*
PATRIOT	PGS34G1600LLKA	4GB(2 x 2GB)	DS	7-7-7-20	1.7	*	*	*
Patriot	PVS34G1600ELK	4GB(2 x 2GB)	DS	9-9-9-24	1.8	*	*	*
Patriot	PVS34G1600LLK(XMP)	4GB(2 x 2GB)	DS	7-7-7-20	1.9	*	*	*
Patriot	PVS34G1600LLKN	4GB(2 x 2GB)	DS	7-7-7-20	2.0	*	*	*

Patriot	PVT36G1600ELK	6GB(3 x 2GB)	DS	9-9-9-24	1.65	•	•	•
Patriot	PVT36G1600ELK	6GB(3 x 2GB)	DS	9-9-9-24	1.65	•	•	•
Patriot	PVT36G1600LLK(XMP)	6GB(3 x 2GB)	DS	8-8-8-24	1.65	•	•	•

Rampage III Formula Motherboard Qualified Vendors Lists (QVL) DDR3-1333MHz capability

Vendors	Part No.	Size	SS/ DS	Chip Brand	Chip NO.	Timing	Voltage	DIMM socket support (Optional)			
								2	3	4	6
A-DATA	SU3U1333B1G9-B	1GB	SS	Hynix	H5TQ1G83TFR	-	-	•	•	•	•
A-DATA	SU3U1333B2G9-B	2GB	DS	Hynix	H5TQ1G83TFR	-	-	•	•	•	•
A-DATA	SU3U1333C4G9-B	4GB	DS	Hynix	H5TQ2G83AFR	-	-	•	•	•	•
Apacer	78.01GC6.9L0	1GB	SS	Apacer	AM5D5808DEJSBG	9	-	•	•	•	•
Apacer	78.A1GC6.9L1	2GB	DS	Apacer	AM5D5808DEWSBG	9	-				
CORSAIR	TR3X3G1333C9 (Ver2.1)	3GB(3 x 1GB)	SS	-	-	9-9-9-24	1.5	•	•	•	•
CORSAIR	CM3X1024-1333C9DHX	1GB	DS	-	-	-	1.1	•			
CORSAIR	CM3X2G1333C9	2GB	DS	-	-	9-9-9-24	1.5				
CORSAIR	BoxP/N:TW3X4G1333C9DHX (CM3X2048-1333C9DHX)Ver3.2	4GB(2 x 2GB)	DS	-	-	9-9-9-24	1.70				
CORSAIR	TR3X6G1333C9 (Ver2.1)	6GB(3 x 2GB)	DS	-	-	9-9-9-24	1.5	•	•	•	•
CORSAIR	CMX8GX3M4A1333C9	8GB(4 x 2GB)	DS	-	-	9-9-9-24	1.5	•	•	•	•
Crucial	CT12864BA1339.8FF	1GB	SS	MICRON	D9KPT	9	-	•			•
Crucial	CT12864BA1339.8SFD	1GB	SS	MICRON	MT8JF12864AY-1G4D1	-	-	•	•		
Crucial	CT12872BA1339.9FF	1GB	SS	MICRON	D9KPT(ECC)	9	-	•	•	•	•
Crucial	BL25664BN1337.16FF(XMP)	2GB	DS	-	-	7-7-7-24	1.65	•	•	•	•
Crucial	CT25664BA1339.16FF	2GB	DS	MICRON	D9KPT	9	-	•	•	•	•
Crucial	CT25664BA1339.16SFD	2GB	DS	MICRON	D9JNM	-	-		•	•	
Crucial	CT25672BA1339.18FF	2GB	DS	MICRON	D9KPT(ECC)	9	-	•	•	•	•
ELPIDA	EBJ10UE8BAW0-DJ-E	1GB	SS	ELPIDA	J1108BABG-DJ-E	9	-	•	•	•	•
ELPIDA	EBJ10UE8BDF0-DJ-F	1GB	SS	ELPIDA	J1108BDSE-DJ-F	-	-	•	•	•	•
ELPIDA	EBJ10UE8EDF0-DJ-F	1GB	SS	ELPIDA	J1108EDSE-DJ-F	-	-	•	•	•	•
ELPIDA	EBJ21UE8BAW0-DJ-E	2GB	DS	ELPIDA	J1108BABG-DJ-E	9	-	•	•	•	•
ELPIDA	EBJ21UE8BDF0-DJ-F	2GB	DS	ELPIDA	J1108BDSE-DJ-F	-	-	•	•	•	•
ELPIDA	EBJ21UE8EDF0-DJ-F	2GB	DS	ELPIDA	J1108EDSE-DJ-F	-	-				
G.SKILL	F3-10600CL7D-2GBPI	2GB(2 x 1GB)	SS	-	-	-	1.65				
G.SKILL	F3-10600CL8D-2GBHK	2GB(2 x 1GB)	SS	-	-	-	1.65	•	•	•	
G.SKILL	F3-10666CL7T-6GBPK(XMP)	2GB	DS	-	-	7-7-7-18	1.5-1.6				
G.SKILL	F3-10666CL7D-4GBPI(XMP)	4GB(2 x 2GB)	DS	-	-	7-7-7-21	1.5				

G.SKILL	F3-10666CL7D-4GBRH(XMP)	4GB(2 x 2GB)	DS	-	-	7-7-7-21	1.5	• • •
G.SKILL	F3-10666CL8D-4GBECO(XMP)	4GB(2 x 2GB)	DS	-	-	8-8-8-24	1.35	• • • •
G.SKILL	F3-10666CL8D-4GBHK(XMP)	4GB(2 x 2GB)	DS	-	-	8-8-8-21	1.5-1.6	• • • •
G.SKILL	F3-10666CL8D-4GBRM(XMP)	4GB(2 x 2GB)	DS	-	-	8-8-8-21	1.5-1.6	
G.SKILL	F3-10666CL9T-6GBN9Q	6GB(3 x 2GB)	DS	-	-	9-9-9-24	1.5	• • • •
G.SKILL	F3-10666CL9D-8GBRLL	8GB (2x 4GB)	DS	-	-	9-9-9-24	1.5	• • •
GEIL	GG34GB1333C9DC	4GB (2x 2GB)	DS	GEIL	GL1L128M88BA115FW	9-9-9-24	1.3	• • • •
GEIL	GB34GB1333C7DC	4GB(2 x 2GB)	DS	GEIL	GL1L128M88BA15FW	7-7-7-24	1.5	• •
GEIL	GG34GB1333C9DC	4GB(2 x 2GB)	DS	GEIL	GL1L128M88BA12N	9-9-9-24	1.3	• • • •
GEIL	GV34GB1333C7DC	4GB(2 x 2GB)	DS	-	-	7-7-7-24	1.5	•
GEIL	GV34GB1333C9DC	4GB(2 x 2GB)	DS	-	-	9-9-9-24	1.5	
Hynix	HMT112U6BFR8C-H9	1GB	SS	Hynix	H5TQ1G83BFR	9	-	• • • •
Hynix	HMT112U6TFR8A-H9	1GB	SS	Hynix	H5TC1G83TFR	-	-	• • • •
Hynix	HMT125U6BFR8C-H9	2GB	DS	Hynix	H5TQ1G83BFR	9	-	
Hynix	HMT125U6BFR8C-H9	2GB	DS	Hynix	H5TQ1G83BFRH9C	9	-	• • • •
Hynix	HMT125U6TFR8A-H9	2GB	DS	Hynix	H5TC1G83TFR	-	-	• • • •
KINGMAX	FLFD45F-B8KL9	1GB	SS	KINGMAX	KFB8FNLXF-BNF-15A	-	-	
KINGMAX	FLFE85F-B8KL9	2GB	DS	KINGMAX	KFB8FNLXL-BNF-15A	-	-	• • • •
Kingston	KVR1333D3N9/1G	1GB	SS	Elpida	J1108BDSE-DJ-F	9	1.5	• • • •
Kingston	KVR1333D3N9/2G(□□)	2GB	DS	Elpida	J1108BDBG-DJ-F	-	1.5	
Kingston	KVR1333D3N9/2G	2GB	DS	Kingston	D1288JFNDPLD9U	9	1.5	• • • •
Kingston	KHX1333C9D3UK2/4GX(XMP)	4GB (2x 2GB)	DS	-	-	9	1.25	• •
MICRON	MT8JTF12864AZ-1G4F1	1GB	SS	MICRON	9FF22 D9KPT	9	-	• • • •
MICRON	MT8JTF12864AZ-1G4F1	1GB	SS	MICRON	D9KPT	9	-	
MICRON	MT9JSF12872AZ-1G4F1	1GB	SS	MICRON	D9KPT(ECC)	9	-	
MICRON	MT16JF25664AZ-1G4F1	2GB	DS	MICRON	D9KPT	9	-	
MICRON	MT16JTF25664AZ-1G4F1	2GB	DS	MICRON	9FF22 D9KPT	9	-	• • • •
MICRON	MT18JSF25672AZ-1G4F1	2GB	DS	MICRON	D9KPT(ECC)	9	-	
OCZ	OCZ3RPX1333EB2GK	1GB	SS	-	-	-	-	•
OCZ	OCZ3RPX1333EB2GK	2GB(2 x 1GB)	SS	NANYA	-	6-5-5	1.85	•
OCZ	OCZ3G1333LV3GK	3GB(3 x 1GB)	SS	-	-	9-9-9	1.65	•
OCZ	OCZ3P1333LV3GK	3GB(3 x 1GB)	SS	-	-	7-7-7	1.65	• • • •
OCZ	OCZ3P13332GK	1GB	DS	-	-	7-7-7-20	-	•
OCZ	OCZ3G1333ULV4GK	4GB (2x 2GB)	DS	-	-	8-8-8	1.35	•
OCZ	OCZ3P1333LV4GK	4GB (2x 2GB)	DS	-	-	-	1.65	• •
OCZ	OCZ3G1333ULV4GK	4GB(2 x 2GB)	DS	-	-	8-8-8	1.65	•
OCZ	OCZ3P13334GK	4GB(2 x 2GB)	DS	-	-	7	1.8	• •
OCZ	OCZ3P1333LV4GK	4GB(2 x 2GB)	DS	-	-	7-7-7	1.65	• • •
OCZ	OCZ3RPX1333EB4GK	4GB(2 x 2GB)	DS	-	-	-	1.85	•
OCZ	OCZ3G1333LV6GK	6GB(3 x 2GB)	DS	-	-	9-9-9	1.65	•
OCZ	OCZ3P1333LV6GK	6GB(3 x 2GB)	DS	-	-	7-7-7	1.65	• • •

OCZ	OCZX1333LV6GK(XMP)	6GB(3 x 2GB)	DS	NA	-	8-8-8	1.6
PSC	AL7F8G73D-DG1	1GB	SS	PSC	A3P1GF3DGF	-	-
PSC	AL8F8G73D-DG1	2GB	DS	PSC	A3P1GF3DGF	-	-
SAMSUNG	M378B2873DZ1-CH9	1GB	SS	SAMSUNG	K4B1G0846D	9	-
SAMSUNG	M378B2873EH1-CH9	1GB	SS	SAMSUNG	K4B1G0846E	-	-
SAMSUNG	M378B2873FHS-CH9	1GB	SS	SAMSUNG	K4B1G0846F	-	-
SAMSUNG	M391B2873DZ1-CH9	1GB	SS	SAMSUNG	K4B1G0846D(ECC)	9	-
SAMSUNG	M378B5673DZ1-CH9	2GB	DS	SAMSUNG	K4B1G0846D	9	-
SAMSUNG	M378B5673EH1-CH9	2GB	DS	SAMSUNG	K4B1G0846E	-	-
SAMSUNG	M378B5673FH0-CH9	2GB	DS	SAMSUNG	K4B1G0846F	-	-
SAMSUNG	M391B5673DZ1-CH9	2GB	DS	SAMSUNG	K4B1G0846D(ECC)	9	-
SAMSUNG	M378B5273BH1-CH9	4GB	DS	SAMSUNG	K4B2G0846B-HCH9	9	-
SAMSUNG	M378B5273CH0-CH9	4GB	DS	SAMSUNG	K4B2G0846C	K4B2G0846C	-
Super Talent	W1333UX2G8(XMP)	2GB(2 x 1GB)	SS	-	-	8	1.8
Transcend	JM1333KLU-1G	1GB	SS	Transcend	TK243EDF3	9	-
Transcend	JM1333KLU-2G	2GB	DS	Transcend	TK243EAF3	9	-
Transcend	N/A	2GB	DS	Elpida	J1108BDBG-DJ-F	-	-
Transcend	TS256MLK64V3U	2GB	DS	ELPIDA	J1108B0BG-DJ-F	9	-
ASUS	N/A	1GB	DS	-	-	-	-
ATP	AQ28M64A8BJH9S	1GB	SS	SAMSUNG	K4B1G0846E	-	-
ATP	AQ28M72D8BJH9S	1GB	SS	SAMSUNG	K4B1G0846D(ECC)	-	-
ATP	AQ56M64B8BJH9S	2GB	DS	SAMSUNG	K4B1G0846D	-	-
ATP	AQ56M72E8BJH9S	2GB	DS	SAMSUNG	K4B1G0846D(ECC)	-	-
ATP	AQ12M72E8BKH9S	4GB	DS	SAMSUNG	K4B2G0846B-HCH9(ECC)	-	-
BUFFALO	FSX1333D3G-1G	1GB	SS	-	-	-	-
BUFFALO	FSH1333D3G-T3G(XMP)	3GB(3 x 1GB)	SS	-	-	7-7-7-20	-
BUFFALO	FSX1333D3G-2G	2GB	DS	-	-	-	-
EK Memory	EKM324L28BP8-113	4GB(2 x 2GB)	DS	-	-	9	-
Elixir	M2F2G64CB88B7N-CG	2GB	SS	Elixir	N2CB2G808N-CG	-	-
Elixir	M2Y2G64CB88A5N-CG	2GB	DS	Elixir	N2CB1G80AN-C6	-	-
Elixir	M2Y2G64CB88A9N-CG	2GB	DS	-	-	-	-
Elixir	M2Y2G64CB88C9N-CG	2GB	DS	-	-	-	-
Elixir	M2F4G64CB88B5N-CG	4GB	DS	Elixir	N2CB2G808N-CG	-	-
GoodRam	GR1333D364L9/2G	2GB	DS	Qimonda	IDS1G-03A1F1C-13H	-	-
KINGTIGER	F10DA2T1680	2GB	DS	KINGTIGER	KTG1333PS1208NST-C9	-	-
KINGTIGER	KTG2G1333PG3	2GB	DS	-	-	-	-
Patriot	PDC32G1333LLK	1GB	SS	PATRIOT	-	7	1.7
Patriot	PVT33G1333ELK	3GB(3 x 1GB)	SS	-	-	9-9-9-24	1.65
Patriot	PSD31G13332	1GB	DS	Patriot	PM64M8D3BU-15	-	-
Patriot	PGS34G1333LLKA	4GB(2 x 2GB)	DS	-	-	7-7-7-20	1.7

Patriot	PVS34G1333ELK	4GB(2 x 2GB)	DS	-	-	9-9-9-24	1.5	•
Patriot	PVS34G1333LLK	4GB(2 x 2GB)	DS	-	-	7-7-7-20	1.7	• •
Patriot	PVT36G1333ELK	6GB(3 x 2GB)	DS	-	-	9-9-9-24	1.65	• • •
PQI	MFACR423PA0105	2GB	DS	PQI	PQC32808E15R	-	-	• • •
Silicon Power	SP001GBLTU1333S01	1GB	SS	NANYA	NT5CB128M8AN-CG	-	-	• • • •
Silicon Power	SP001GBLTU1333S02	1GB	SS	S-POWER	I0YT3E0	9	-	• • • •
Silicon Power	SP002GBLTU1333S02	2GB	DS	S-POWER	I0YT3E0	9	-	• • • • •
Silicon Power	SP001GBLTE1333S01	1GB	SS	NANYA	NT5CB128M8AN-CG	-	-	• • • •
Silicon Power	SP002GBLTE1333S01	2GB	DS	NANYA	NT5CB128M8AN-CG	-	-	• • • • •
UMAX	E41302GP0-73BDB	2GB	DS	UMAX	U2S24D30TP-13	-	-	



6 DIMM Slots

- 2 DIMM: Supports two (2) modules inserted into slot A1 and B1 as one pair of Dual-channel memory configuration.
- 3 DIMM: Supports three (3) modules inserted into the red slots (A1, B1 and C1) as one set of Triple-channel memory configuration.
- 4 DIMM: Supports four (4) modules inserted into the red slots (A1, B1 and C1) and the grey slot A2 as one set of Triple-channel memory configuration
- 6 DIMM: Supports six (6) modules inserted into both the red slots and the grey slots as two set of Triple-channel memory configuration.
- When installing total memory of 4GB capacity or more, Windows 32-bit operation system may only recognize less than 3GB. Hence, a total installed memory of less than 3GB is recommended.
- It is recommended to install the memory modules from the red slots for better overclocking capability.
- The default DIMM frequency depends on its Serial Presence Detect (SPD), which is the standard way of accessing information from a memory module. Under the default state, some memory modules for overclocking may operate at a lower frequency than the vendor-marked value.

2.4.3 Installing a DIMM



Ensure to unplug the power supply before adding or removing DIMMs or other system components. Failure to do so may cause severe damage to both the motherboard and the components.

1. Unlock a DIMM socket by pressing the retaining clip outward.
2. Align a DIMM on the socket such that the notch on the DIMM matches the DIMM slot key on the socket.

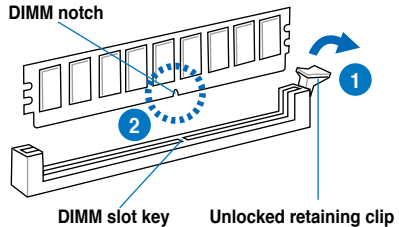

A DIMM is keyed with a notch so that it fits in only one direction. **DO NOT** force a DIMM into a socket in the wrong direction to avoid damaging the DIMM.

3. Hold the DIMM by both of its ends, then insert the DIMM vertically into the socket. Apply force to both ends of the DIMM simultaneously until the retaining clip snaps back into place, and the DIMM cannot be pushed in any further to ensure proper sitting of the DIMM.

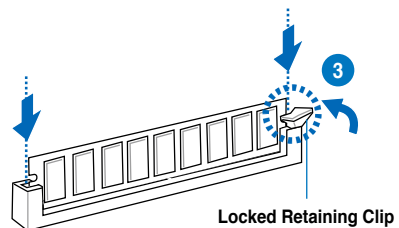

Always insert the DIMM into the socket **VERTICALLY** to prevent DIMM notch damage.

2.4.4 Removing a DIMM

1. Press the retaining clip outward to unlock the DIMM.
2. Remove the DIMM from the socket.

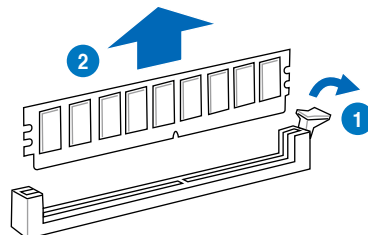

2.5 Expansion slots

In the future, you may need to install expansion cards. The following sub-sections describe the slots and the expansion cards that they support.



Ensure to unplug the power cord before adding or removing expansion cards. Failure to do so may cause you physical injury and damage motherboard components.

2.5.1 Installing an expansion card

To install an expansion card:

1. Before installing the expansion card, read the documentation that came with it and make the necessary hardware settings for the card.
2. Remove the system unit cover (if your motherboard is already installed in a chassis).
3. Remove the bracket opposite the slot that you intend to use. Keep the screw for later use.
4. Align the card connector with the slot and press firmly until the card is completely seated on the slot.
5. Secure the card to the chassis with the screw you removed earlier.
6. Replace the system cover.

2.5.2 Configuring an expansion card

After installing the expansion card, configure it by adjusting the software settings.

1. Turn on the system and change the necessary BIOS settings, if any. See Chapter 3 for information on BIOS setup.
2. Assign an IRQ to the card. Refer to the tables on the next page.
3. Install the software drivers for the expansion card.



When using PCI cards on shared slots, ensure that the drivers support “Share IRQ” or that the cards do not need IRQ assignments. Otherwise, conflicts will arise between the two PCI groups, making the system unstable and the card inoperable. Refer to the table on the next page for details.

2.5.3 Interrupt assignments

Standard interrupt assignments

IRQ	Priority	Standard function
0	1	System Timer
1	2	Keyboard Controller
2	–	Redirect to IRQ#9
4	12	Communications Port (COM1)*
5	13	IRQ Holder for PCI Steering*
6	14	Reserved
7	15	Reserved
8	3	System CMOS/Real Time Clock
9	4	IRQ Holder for PCI Steering*
10	5	IRQ Holder for PCI Steering*
11	6	IRQ Holder for PCI Steering*
12	7	Reserved
13	8	Numeric Data Processor
14	9	Primary IDE Channel

* These IRQs are usually available for PCI devices.

IRQ assignments for this motherboard

	A	B	C	D	E	F	G	H
PCIEX16_1	shared	-	-	-	-	-	-	-
PCIEX16/X1_2	shared	-	-	-	-	-	-	-
PCIEX16/X8_3	shared	-	-	-	-	-	-	-
PCIEX1_1	shared	-	-	-	-	-	-	-
PCIEX1_2	-	shared	-	-	-	-	-	-
USB 1.0#1	-	-	-	-	-	-	-	shared
USB 1.0#2	-	-	-	-	-	shared	-	-
USB 1.0#3	-	-	shared	-	-	-	-	-
USB 1.0#4	shared	-	-	-	-	-	-	-
USB 1.0#5	-	-	-	-	-	shared	-	-
USB 1.0#6	shared	-	-	-	-	-	-	-
USB 1.0#7	-	-	-	shared	-	-	-	-
USB 2.0#1	-	-	-	-	-	-	-	shared
USB 2.0#2	-	-	shared	-	-	-	-	-
Intel 82657V	-	-	-	-	-	-	shared	-
SATA_1	-	-	shared	-	-	-	-	-
SATA_2	-	-	-	-	shared	-	-	-
Marvell 9128	shared	-	-	-	-	-	-	-
JMB36X	shared	-	-	-	-	-	-	-
HD Audio	-	-	-	-	-	-	shared	-
IEEE 1394	-	-	-	shared	-	-	-	-
PCI1	shared	-	-	-	-	-	-	-
NEC USB 3.0	shared	-	-	-	-	-	-	-

2.5.4 PCI slot

The PCI slot supports cards such as a LAN card, SCSI card, USB card, and other cards that comply with PCI specifications. Refer to the figure below for the location of the slot.

2.5.5 PCI Express x1 slots

This motherboard has two PCI Express x1 slots that support PCI Express x1 cards complying with the PCI Express specifications. Refer to the figure below for the location of the slot.

2.5.6 PCI Express x16 slots

This motherboard has three PCI Express x16 slots that support PCI Express x16 cards complying with the PCI Express specifications. Refer to the figure below for the location of the slot.

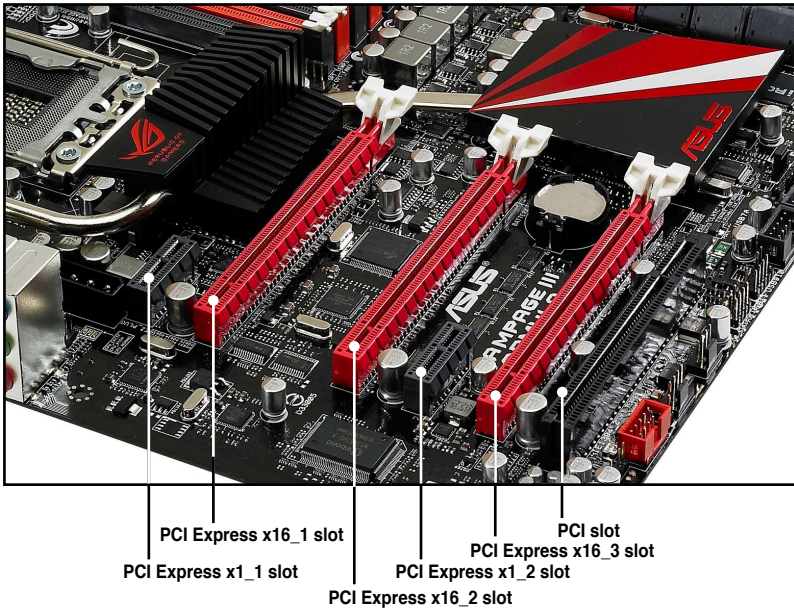

- Refer to the following configuration table for installation.

PCIex16 Slot #	Single VGA	SLI/CF	3 way SLI/CFX
1	x16	x16	x16
2	—	—	x8
3	—	x16	x8

- We recommend that you provide sufficient power when running CrossFireX™ or SLI mode. See page 2-45 for details.
- Connect a chassis fan to the motherboard connector labeled CHA_FAN1/2/3 when using multiple graphics cards for better thermal environment.

2.6 Jumper

1. Clear RTC RAM (3-pin CLRTC_SW)

This jumper allows you to enable the **clr CMOS** switch on the back I/O. You can clear the CMOS memory and system setup parameters by erasing the CMOS RTC RAM data. The **clr CMOS** switch on the back I/O helps you easily clear the system setup information such as system passwords.

To erase the RTC RAM:

1. Press down the **clr CMOS** switch on the back I/O.
2. Hold down the key during the boot process and enter BIOS setup to re-enter data.

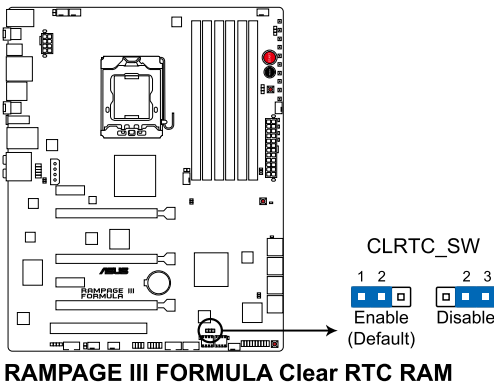

clr CMOS switch behavior

System power state	G3*	S5*	S0 (DOS mode)	S0 (OS mode)	S1	S3	S4
Clearing CMOS	•	•	•**				

*G3: Power off without +5VSB power (AC power loss); S5: Power off with +5VSB power

**The system shuts down immediately.



- The **clr CMOS** switch will not function if the CLRTC_SW jumper is moved to the Disable position.
- Ensure to re-enter your previous BIOS settings after you clear the CMOS.
- You do not need to clear the RTC when the system hangs due to CPU overclocking. With the C.P.R. (CPU Parameter Recall) feature, shut down and reboot the system so the BIOS can automatically reset CPU parameter settings to default values.

2. LN2 Mode jumper (3-pin LN2)

With LN2 mode activated, the ROG motherboard is optimized to remedy the cold-boot bug during POST at an extremely low temperature and help the system boot successfully.

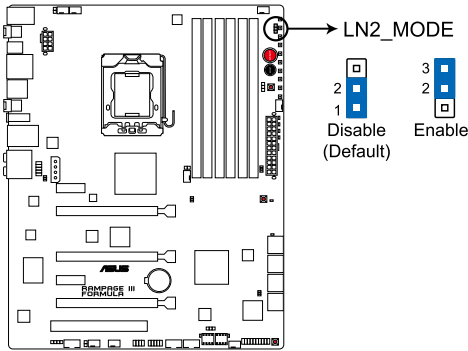

RAMPAGE III FORMULA LN2_MODE

3. QPI_LL (3-pin QPI_LL_SW)

This jumper prevents QPI voltage from dropping too much when you perform overclocking. The low QPI voltage may cause system malfunction. Set the jumper to pin 2—3 to activate this function and pin 1—2 to disable this function.

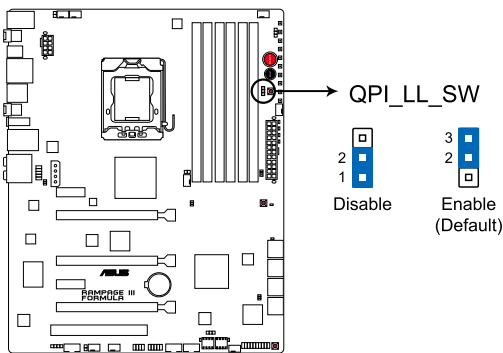

RAMPAGE III FORMULA QPI_LL switch

2.7 I/O shield Installation

1. Install the I/O shield to the chassis by snapping it in place from inside.



2. Orient the motherboard and install it to the chassis. Ensure that the motherboard external ports fit the I/O openings.



Be cautious when installing the motherboard. The I/O shield edge springs may damage the I/O ports.



The photos above are for reference only, the actual I/O shield may differ by models.

2.8 Connectors

2.8.1 Rear panel connectors

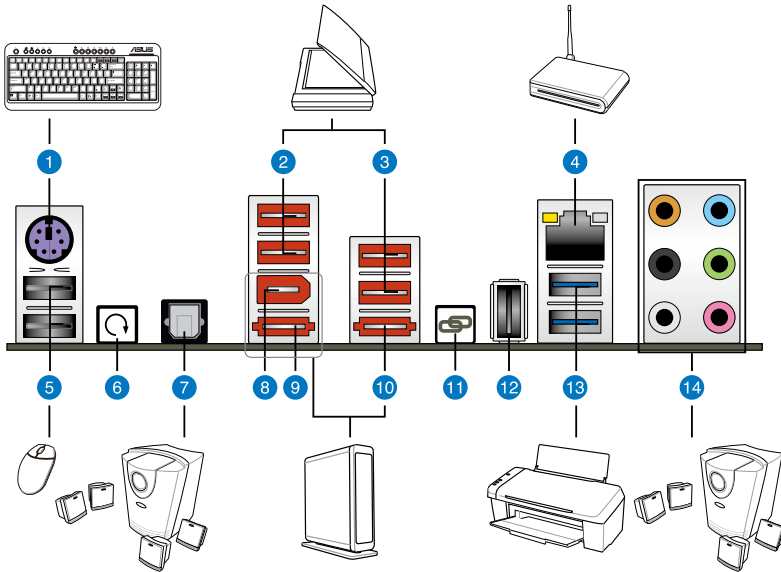

Rear panel connectors

1.	PS/2 keyboard port (purple)	8.	IEEE 1394a port
2.	USB 2.0 ports 3 and 4	9.	Power External SATA port
3.	USB 2.0 ports 1 and 2	10.	External SATA port
4.	LAN (RJ-45) port*	11.	ROG Connect switch
5.	USB 2.0 ports 5 and 6	12.	ROG Connect port
6.	Clear CMOS switch	13.	USB 3.0 ports 1 and 2
7.	Optical S/PDIF Out port	14.	Audio ports



To use hot-plug, set the **Controller Mode** in the BIOS settings to [AHCI] mode. See section **3.5.3 Onboard Devices Configuration** for details.

* LAN port LED indications

Activity/Link	Speed LED	Description
OFF	OFF	Soft-off Mode
Yellow Blinking	OFF	During Power ON/OFF
Yellow Blinking	ORANGE	100 Mbps connection
Yellow Blinking	GREEN	1 Gbps connection

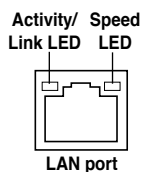

2.8.2 ROG Connect switch

The ROG Connect function allows you to monitor and control remotely with the other computer through the provided ROG Connect cable.

To use ROG Connect:

1. Connect one end of the ROG Connect cable to the ROG Connect port and the other to your notebook or netbook.
2. Press the switch to start to connection.

2.8.3 Audio I/O connections

Audio 2, 4, 6, or 8-channel configuration

Port	Headset 2-channel	4-channel	6-channel	8-channel
Light Blue	Line In	Line In	Line In	Line In
Lime	Line Out	Front Speaker Out	Front Speaker Out	Front Speaker Out
Pink	Mic In	Mic In	Mic In	Mic In
Orange	–	–	Center/ Subwoofer	Center/ Subwoofer
Black	–	Rear Speaker Out	Rear Speaker Out	Rear Speaker Out
Gray	–	–	–	Side Speaker Out

Audio I/O ports

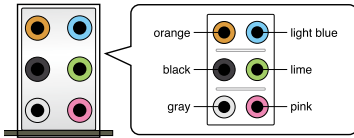

Connect to Headphone and Mic



Connect to Stereo / 2.1-channel Speakers

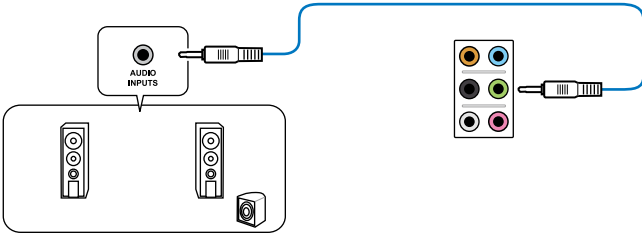

Connect to 4.1-channel Speakers

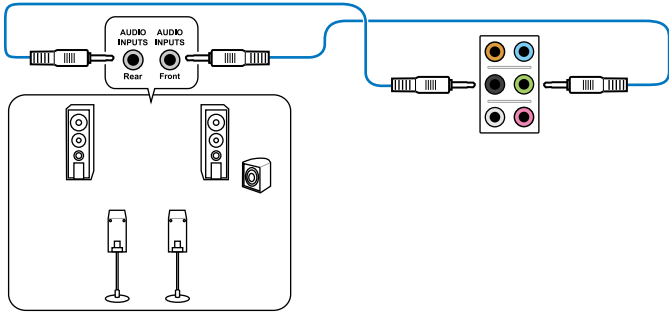

Connect to 5.1-channel Speakers

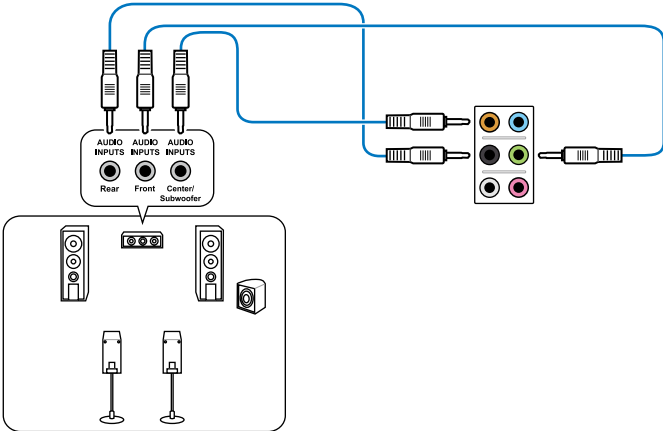

Connect to 7.1-channel Speakers

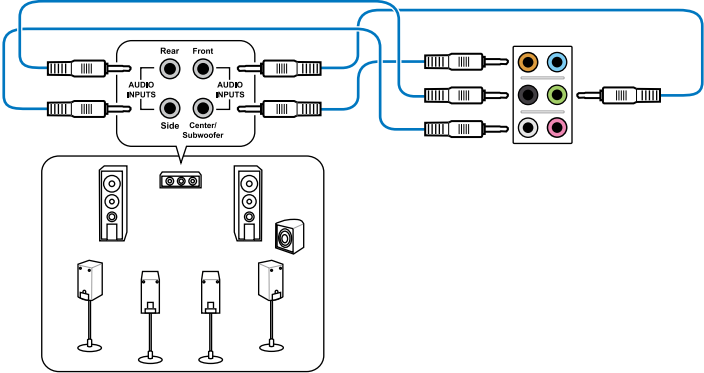

2.8.4 Internal connectors

1. ICH10R Serial ATA connectors (7-pin SATA 1-6 [grey])

These connectors are for the Serial ATA signal cables for Serial ATA hard disk drives and optical disc drives.

If you installed Serial ATA hard disk drives, you can create a RAID 0, 1, 5, and 10 configuration with the Intel® Matrix Storage Technology through the onboard Intel® ICH10R RAID controllers.

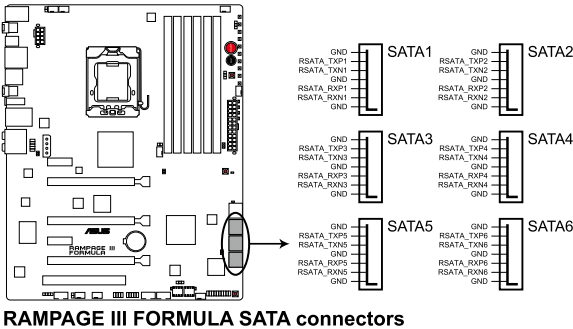

RAMPAGE III FORMULA SATA connectors

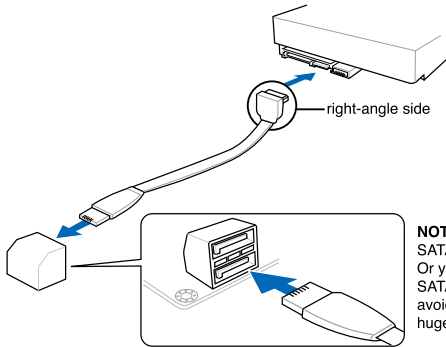

NOTE: Connect the right-angle side of SATA signal cable to SATA device. Or you may connect the right-angle side of SATA cable to the onboard SATA port to avoid mechanical conflict with huge graphics cards.



- These connectors are set to Standard IDE mode by default. In Standard IDE mode, you can connect Serial ATA boot/data hard disk drives to these connectors. If you intend to create a Serial ATA RAID set using these connectors, set the **Configure SATA as** item in the BIOS to [RAID]. See section 3.4.5 Storage Configuration for details.
- Before creating a RAID set, refer to section 4.4 RAID configurations or the manual bundled in the motherboard support DVD.
- You must install Windows® XP Service Pack 2 or later versions before using Serial ATA hard disk drives. The Serial ATA RAID feature is available only if you are using Windows® XP SP2 or later versions.
- When using hot-plug and NCQ, set the **Configure SATA as** in the BIOS to [AHCI]. See section 3.4.5 Storage Configuration for details.

2. Marvell® Serial ATA 6.0 Gb/s connectors (7-pin SATA_6G_1/2 [red])

These connectors connect to Serial ATA 6.0 Gb/s hard disk drives via Serial ATA 6.0 Gb/s signal cables.

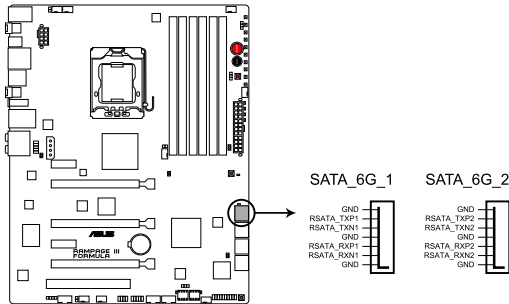

RAMPAGE III FORMULA SATA_6G connectors



- These connectors are set to Standard IDE mode by default. In Standard IDE mode, you can connect Serial ATA data hard disk drives to these connectors.
- You must install Windows® XP Service Pack 2 or later versions before using Serial ATA hard disk drives.
- When using hot-plug and NCQ, set the **Onboard SATA6G Controller** item in the BIOS to [AHCI Mode]. Refer to section **3.5.3 Onboard Devices Configuration** for details.

3. USB connectors (10-1 pin USB78, USB910, USB11)

These connectors are for USB 2.0 ports. Connect the USB module cables to these connectors, then install the modules to the slots opening at the back of the system chassis. These USB connectors comply with USB 2.0 specification that supports up to 480 Mbps connection speed.

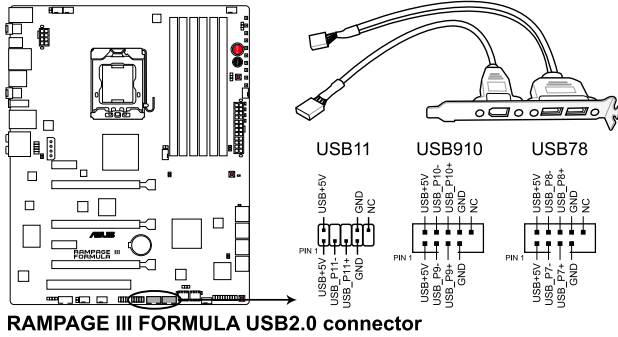

Never connect a 1394 cable to the USB connectors. Doing so will damage the motherboard!



You can connect the USB cable to ASUS Q-Connector (USB, blue) first, and then install the Q-Connector (USB) to the USB connector onboard.

4. OC station connector (8-pin OC_Station)

This connector is for ASUS OC Station connection only. Connect one end of the supplied data cable to the GP connector on the OC Station and the other end to this connector and USB11 on the motherboard to enjoy easier overclocking.

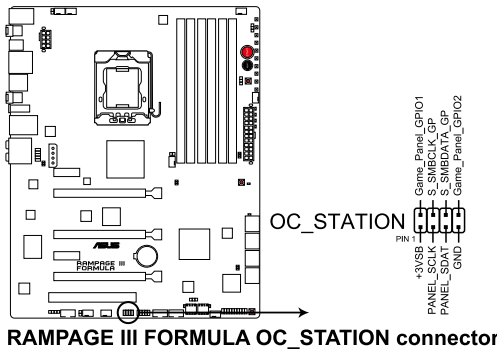

5. IEEE 1394a port connector (10-1 pin IE1394_2)

This connector is for an IEEE 1394a port. Connect the IEEE 1394a module cable to this connector, then install the module to a slot opening at the back of the system chassis.

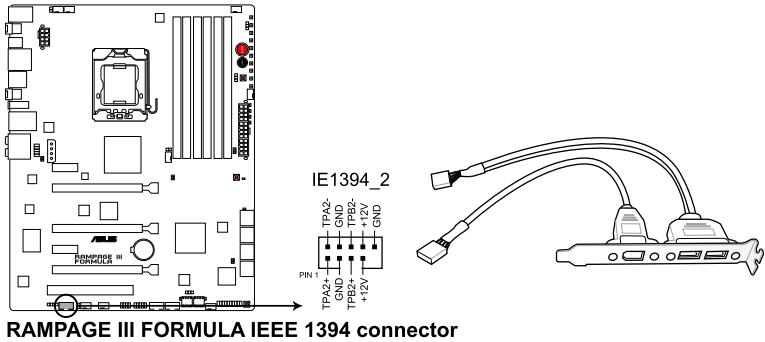

Never connect a USB cable to the IEEE 1394a connector. Doing so will damage the motherboard!



The IEEE 1394a module is purchased separately.

6. CPU, chassis, and optional fan connectors (4-pin CPU_FAN, 4-pin PWR_FAN, 4-pin CHA_FAN1-3, 4-pin OPT_FAN1-3)

The fan connectors support cooling fans of 350 mA–2000 mA (24 W max.) or a total of 1 A–7 A (84 W max.) at +12V. Connect the fan cables to the fan connectors on the motherboard, ensuring that the black wire of each cable matches the ground pin of the connector.



DO NOT forget to connect the fan cables to the fan connectors. Insufficient air flow inside the system may damage the motherboard components. These are not jumpers! DO NOT place jumper caps on the fan connectors!

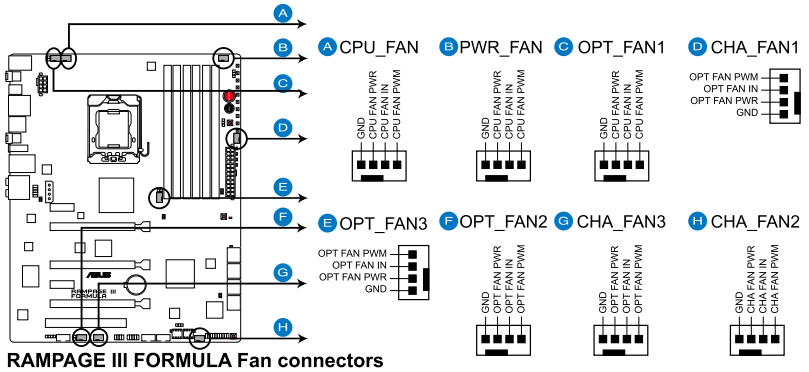

If you install two VGA cards, we recommend that you plug the chassis fan cable to the motherboard connector labeled OPT_FAN1/2/3 for better thermal environment.

7. Thermal sensor cable connectors (2-pin OPT_TEMP1/2/3)

These connectors are for temperature monitoring. Connect the thermal sensor cables to these connectors and place the other ends to the devices which you want to monitor temperature. The optional fan1/2/3 can work with the temperature sensors for a better cooling effect.

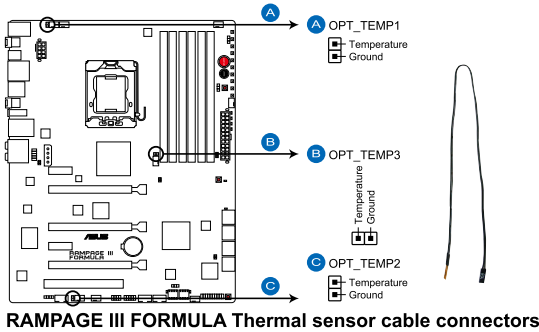

Enable **OPT FAN1/2/3 overheat protection** in BIOS if you connect thermal sensor cables to these connectors.



The thermal sensor cable is purchased separately and is included in the package only on selected models.

8. Digital audio connector (4-1 pin SPDIF_OUT)

This connector is for an additional Sony/Philips Digital Interface (S/PDIF) port(s). Connect the S/PDIF Out module cable to this connector, then install the module to a slot opening at the back of the system chassis.

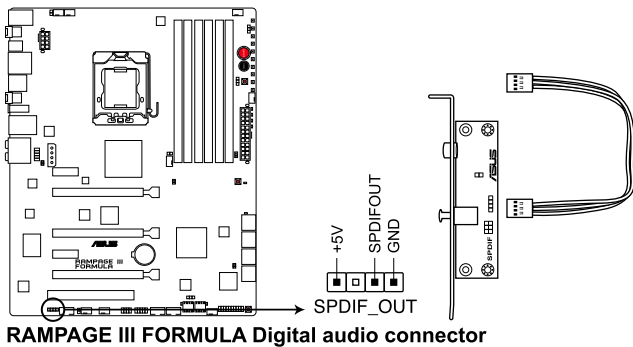

9. Front panel audio connector (10-1 pin AAFP)

This connector is for a chassis-mounted front panel audio I/O module that supports either HD Audio or legacy AC'97 audio standard. Connect one end of the front panel audio I/O module cable to this connector.

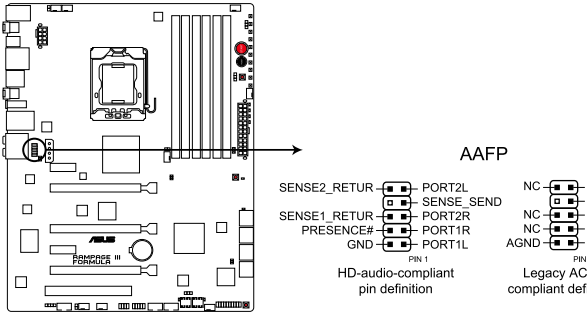

RAMPAGE III FORMULA Analog front panel connector



- We recommend that you connect a high-definition front panel audio module to this connector to avail of the motherboard's high-definition audio capability.
- If you want to connect a high-definition front panel audio module to this connector, set the **Front Panel Type** item in the BIOS setup to **[HD Audio]**; if you want to connect an AC'97 front panel audio module to this connector, set the item to **[AC97]**. By default, this connector is set to **[HD Audio]**.

10. ATX power connectors (24-pin EATXPWR, 8-pin EATX12V, 4-pin EZ_PLUG)

These connectors are for ATX power supply plugs. The power supply plugs are designed to fit these connectors in only one orientation. Find the proper orientation and push down firmly until the connectors completely fit.

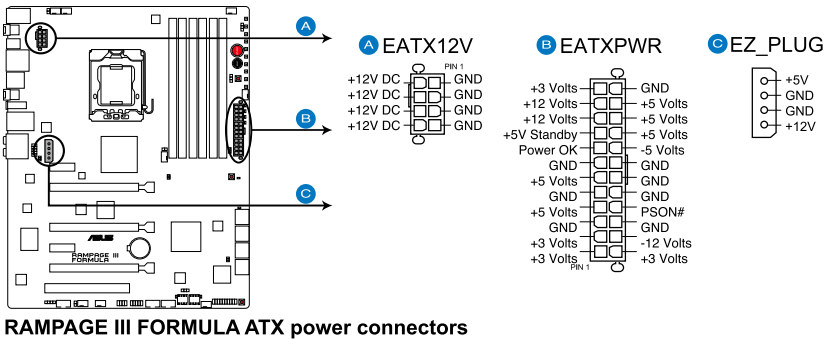

- For a fully configured system, we recommend that you use a power supply unit (PSU) that complies with ATX 12 V Specification 2.0 (or later version) and provides a minimum power of 600 W.
- Do not forget to connect the 8-pin EATX12V power plug; otherwise, the system will not boot.
- Connect the 4-pin EZ_PLUG power plug to ensure sufficient power supply when you install multiple graphics cards.
- Use of a PSU with a higher power output is recommended when configuring a system with more power-consuming devices. The system may become unstable or may not boot up if the power is inadequate.
- If you are uncertain about the minimum power supply requirement for your system, refer to the Recommended Power Supply Wattage Calculator at <http://support.asus.com/PowerSupplyCalculator/PSCalculator.aspx?SLanguage=en-us> for details.

11. System panel connector (20-8 pin PANEL)

This connector supports several chassis-mounted functions.

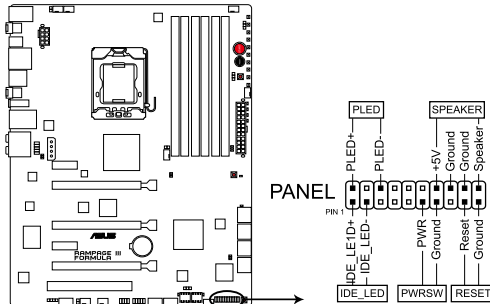

RAMPAGE III FORMULA System panel connector

- **System power LED (2-pin PLED)**

This 2-pin connector is for the system power LED. Connect the chassis power LED cable to this connector. The system power LED lights up when you turn on the system power, and blinks when the system is in sleep mode.

- **Hard disk drive activity LED (2-pin IDE_LED)**

This 2-pin connector is for the HDD Activity LED. Connect the HDD Activity LED cable to this connector. The IDE LED lights up or flashes when data is read from or written to the HDD.

- **System warning speaker (4-pin SPEAKER)**

This 4-pin connector is for the chassis-mounted system warning speaker. The speaker allows you to hear system beeps and warnings.

- **ATX power button/soft-off button (2-pin PWRSW)**

This connector is for the system power button. Pressing the power button turns the system on or puts the system in sleep or soft-off mode depending on the BIOS settings. Pressing the power switch for more than four seconds while the system is ON turns the system OFF.

- **Reset button (2-pin RESET)**

This 2-pin connector is for the chassis-mounted reset button for system reboot without turning off the system power.

12. ASUS Q-Connector (system panel)

Use the ASUS Q-Connector to connect/disconnect the chassis front panel cables.

To install the ASUS Q-Connector:

1. Connect the front panel cables to the ASUS Q-Connector.

Refer to the labels on the Q-Connector to know the detailed pin definitions, and then match them to their respective front panel cable labels.



The labels on the front panel cables may vary depending on the chassis model.

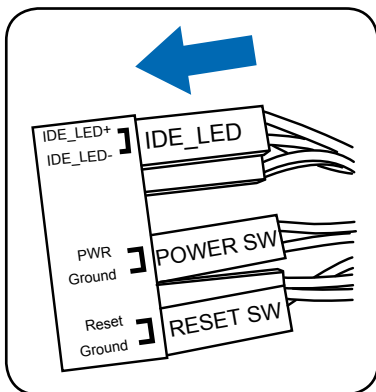

2. Install the ASUS Q-Connector to the system panel connector, ensuring the orientation matches the labels on the motherboard.

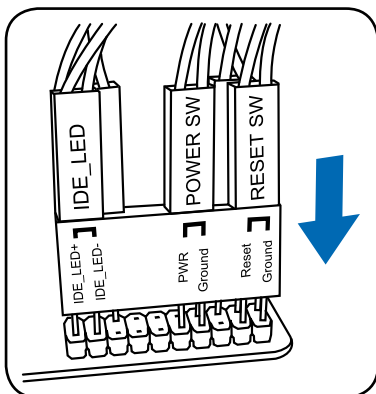

3. The front panel functions are now enabled. The figure shows the Q-Connector is properly installed on the motherboard.

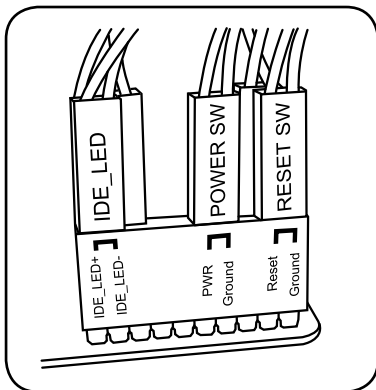

2.8.5 Onboard switches

Onboard switches allow you to fine-tune performance when working on a bare or open-case system. This is ideal for overclockers and gamers who continually change settings to enhance system performance.

1. Power-on switch

Press the power-on switch to wake/power up the system.

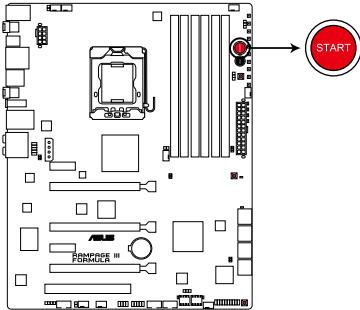

RAMPAGE III FORMULA Power on switch

2. Reset switch

Press the reset switch to reboot the system.

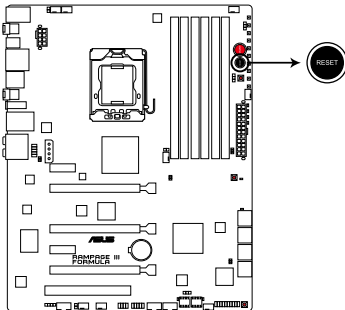

RAMPAGE III FORMULA Reset switch

3. GO button

Press the GO button before POST to enable MemOK! or press it to quickly load the preset profile (GO_Button file) for temporary overclocking when in OS.

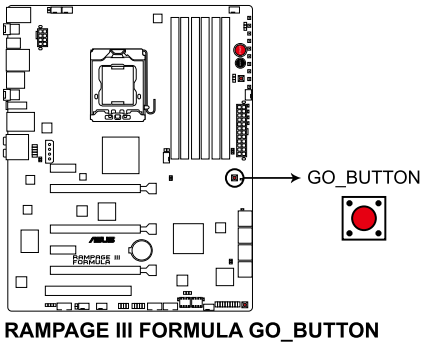

4. BIOS button

The motherboard comes with two BIOS. Press the BIOS button to switch BIOS and load different BIOS settings. The nearby BIOS LEDs indicate the BIOS you are using.

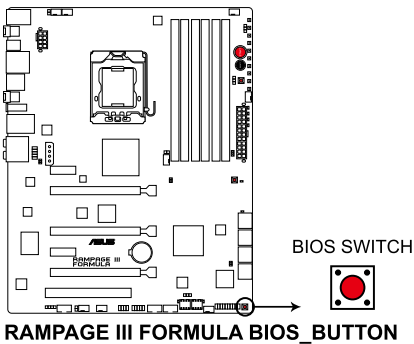

5. Q reset button

When the LN2_Mode jumper does not work and your CPU cannot resume function, press the Q reset button to temporarily stop the power supply to the CPU and help the CPU recover from a frozen condition.

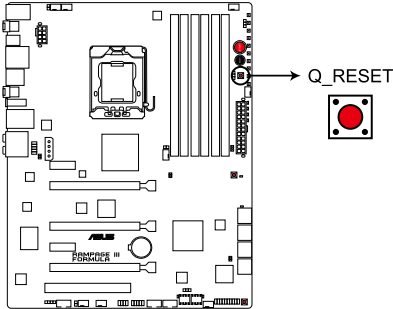

RAMPAGE III FORMULA Q_RESET BUTTON

2.8.6 Probel

The ROG Probel feature provides a nice touch for your convenient and accurate OC settings. No time wasted fumbling around on the complicated motherboard layout, the clearly marked area gives you easier access to the measure points when a multimeter is employed for more accurate measurements during your busy overclocking work.

Refer to the following illustration for Probel location.

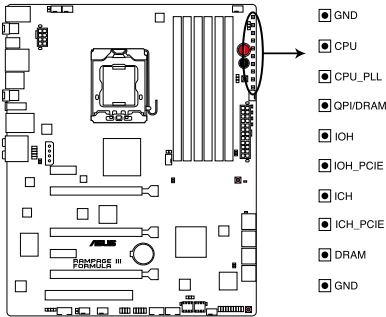

RAMPAGE III FORMULA Probel

Using Probel

You may connect the multimeter to the motherboard as shown.

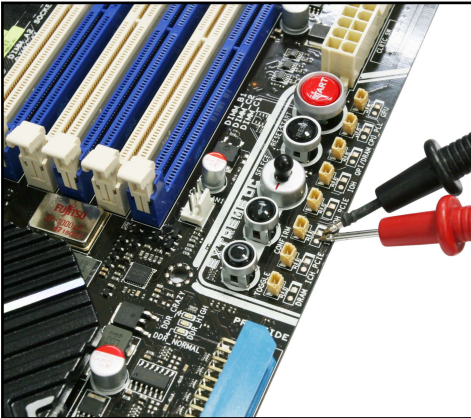

The photos above are for reference only, the actual motherboard layout and measure points location may differ by models.

2.9 Starting up for the first time

1. After making all the connections, replace the system case cover.
2. Be sure that all switches are off.
3. Connect the power cord to the power connector at the back of the system chassis.
4. Connect the power cord to a power outlet that is equipped with a surge protector.
5. Turn on the devices in the following order:
 - a. Monitor
 - b. External SCSI devices (starting with the last device on the chain)
 - c. System power
6. After applying power, the system power LED on the system front panel case lights up. For systems with ATX power supplies, the system LED lights up when you press the ATX power button. If your monitor complies with “green” standards or if it has a “power standby” feature, the monitor LED may light up or switch between orange and green after the system LED turns on.

The system then runs the power-on self tests or POST. While the tests are running, the BIOS beeps (see BIOS beep codes table below) or additional messages appear on the screen. If you do not see anything within 30 seconds from the time you turned on the power, the system may have failed a power-on test. Check the jumper settings and connections or call your retailer for assistance.

BIOS Beep	Description
One short beep	VGA detected Quick boot set to disabled No keyboard detected
One continuous beep followed by two short beeps then a pause (repeated)	No memory detected
One continuous beep followed by three short beeps	No VGA detected
One continuous beep followed by four short beeps	Hardware component failure

7. At power on, hold down the <Delete> key to enter the BIOS Setup. Follow the instructions in Chapter 3.

2.10 Turning off the computer

2.10.1 Using the OS shut down function

If you are using Windows® Vista™/ Windows® 7:

1. Click the **Start** button then select **Shut Down**.
2. The power supply should turn off after Windows® shuts down.

If you are using Windows® XP:

1. Click the **Start** button then select **Turn Off Computer**.
2. Click the **Turn Off** button to shut down the computer.
3. The power supply should turn off after Windows® shuts down.

2.10.2 Using the dual function power switch

While the system is ON, pressing the power switch for less than four seconds puts the system to sleep mode or to soft-off mode, depending on the BIOS setting.

Pressing the power switch for more than four seconds lets the system enter the soft-off mode regardless of the BIOS setting. Refer to section **3.6 Power Menu** in Chapter 3 for details.

This chapter tells how to change the system settings through the BIOS Setup menus. Detailed descriptions of the BIOS parameters are also provided.

BIOS Setup **3**

3.1	Managing and updating your BIOS	3-1
3.2	BIOS Setup program	3-6
3.3	Extreme Tweaker menu	3-9
3.4	Main menu	3-17
3.5	Advanced menu	3-23
3.6	Power menu	3-33
3.7	Boot menu	3-39
3.8	Tools menu	3-43
3.9	Exit menu	3-50

3.1 Managing and updating your BIOS

The following utilities allow you to manage and update the motherboard Basic Input/Output System (BIOS) Setup.

1. **ASUS Update** (Updates the BIOS in Windows® environment.)
2. **ASUS EZ Flash 2** (Updates the BIOS using a floppy disk or USB flash disk.)
3. **ASUS CrashFree BIOS 3 utility:** Restores the BIOS using the motherboard support DVD or a USB flash drive when the BIOS file fails or gets corrupted.

Refer to the corresponding sections for details on these utilities.



Save a copy of the original motherboard BIOS file to a USB flash drive in case you need to restore the BIOS in the future. Copy the original motherboard BIOS using the **ASUS Update** utility.

3.1.1 ASUS Update utility

The ASUS Update is a utility that allows you to manage, save, and update the motherboard BIOS in Windows® environment. The ASUS Update utility allows you to:

- Save the current BIOS file
- Download the latest BIOS file from the Internet
- Update the BIOS from an updated BIOS file
- Update the BIOS directly from the Internet, and
- View the BIOS version information.

This utility is available in the support DVD that comes with the motherboard package.



ASUS Update requires an Internet connection either through a network or an Internet Service Provider (ISP).

Installing ASUS Update

To install ASUS Update:

1. Place the support DVD in the optical drive. The Drivers menu appears.
2. Click the Utilities tab, then click Install ASUS Update VX.XX.XX.
3. The ASUS Update utility is copied to your system.



Quit all Windows® applications before you update the BIOS using this utility.

Updating the BIOS through the Internet

To update the BIOS through the Internet:

1. Launch the ASUS Update utility from the Windows® desktop by clicking **Start > Programs > ASUS > ASUSUpdate > ASUSUpdate**. The ASUS Update main window appears.

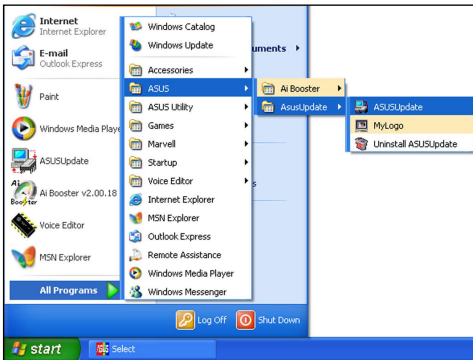

2. Select **Update BIOS** from the Internet option from the drop-down menu, then click **Next**.
3. Select the ASUS FTP site nearest you to avoid network traffic, or click **Auto Select**. Click **Next**.

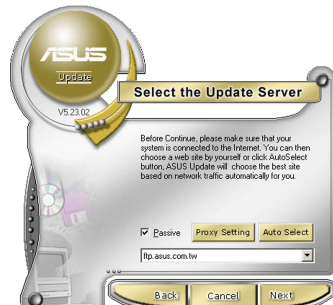
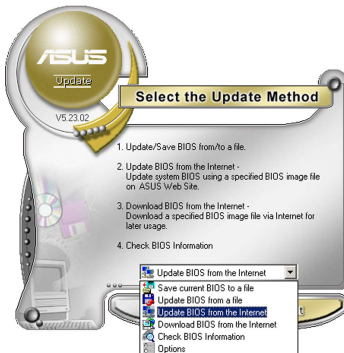

- From the FTP site, select the BIOS version that you wish to download. Click **Next**.
- Follow the screen instructions to complete the update process.



The ASUS Update utility is capable of updating itself through the Internet. Always update the utility to avail all its features.

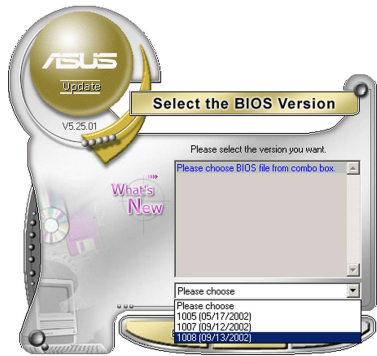

Updating the BIOS through a BIOS file

To update the BIOS through a BIOS file:

- Launch the ASUS Update utility from the Windows® desktop by clicking **Start** > **Programs** > **ASUS** > **ASUSUpdate** > **ASUSUpdate**. The ASUS Update main window appears.
- Select **Update BIOS** from a file option from the drop-down menu, then click **Next**.

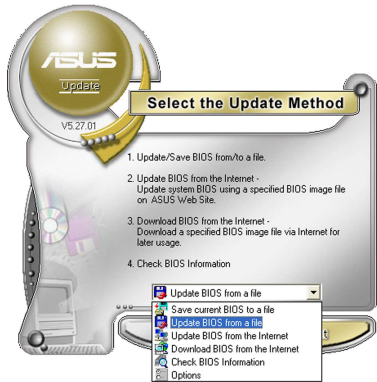

- Locate the BIOS file from the Open window, then click **Open**.
- Follow the screen instructions to complete the update process.

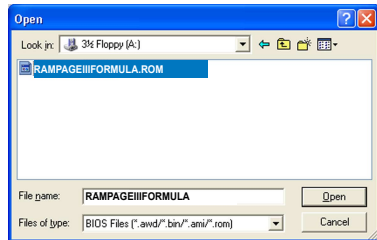

3.1.2 ASUS EZ Flash 2 utility

The ASUS EZ Flash 2 feature allows you to update the BIOS without having to use a DOS-based utility. The EZ Flash 2 utility is built in the BIOS chip so it is accessible by pressing <Alt> + <F2> during the Power-On Self Tests (POST).



Before you start using this utility, download the latest BIOS from the ASUS website at www.asus.com.

To update the BIOS using EZ Flash 2

1. Insert the USB flash disk that contains the latest BIOS file to the USB port, and then launch EZ Flash 2 in any of these two ways:
 - Press <Alt> + <F2> during POST to display the following.
 - Enter the BIOS Setup program. Go to the **Tools** menu to select **EZ Flash 2** and press <Enter> to enable it.

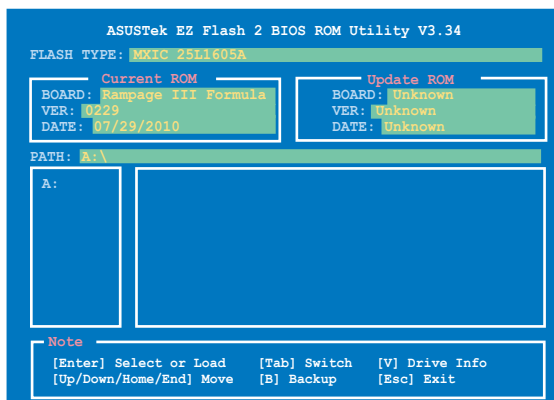

2. Press <Tab> to switch between drives until the correct BIOS file is found. When found, EZ Flash 2 performs the BIOS update process and automatically reboots the system when done.



- This function can support devices such as a USB flash disk with FAT 32/16 format and single partition only.
- DO NOT shut down or reset the system while updating the BIOS to prevent system boot failure!



Ensure to load the BIOS default settings to ensure system compatibility and stability. Select the **Load Setup Defaults** item under the **Exit** menu. See section **3.9 Exit Menu** for details.

3.1.3 ASUS CrashFree BIOS 3 utility

The ASUS CrashFree BIOS 3 utility is an auto recovery tool that allows you to restore the BIOS file when it fails or gets corrupted during the updating process. You can restore a corrupted BIOS file using the motherboard support DVD or a USB flash drive that contains the BIOS file.



The BIOS file in the motherboard support DVD may be older than the BIOS file published on the ASUS official website. If you want to use the newer BIOS file, download the file at support.asus.com and save it to a USB flash drive.

Recovering the BIOS

To recover the BIOS

1. Turn on the system.
2. Insert the motherboard support DVD to the optical drive, or the USB flash drive containing the BIOS file to the USB port.
3. The utility automatically checks the devices for the BIOS file. When found, the utility reads the BIOS file and starts flashing the corrupted BIOS file.
4. Turn off the system after the utility completes the updating process and power on again.
5. The system requires you to enter BIOS Setup to recover BIOS setting. To ensure system compatibility and stability, we recommend that you press <F2> to load default BIOS values.



DO NOT shut down or reset the system while recovering the BIOS! Doing so can cause system boot failure!

3.2 BIOS Setup program

This motherboard supports two programmable firmware chips that you can update using the provided utility described in section 3.1 **Managing and updating your BIOS**.

Use the BIOS Setup program when you are installing a motherboard, reconfiguring your system, or prompted to “Run Setup.” This section explains how to configure your system using this utility.

Even if you are not prompted to use the Setup program, you can change the configuration of your computer in the future. For example, you can enable the security password feature or change the power management settings. This requires you to reconfigure your system using the BIOS Setup program so that the computer can recognize these changes and record them in the CMOS RAM of the firmware chip.

The firmware chip on the motherboard stores the Setup utility. When you start up the computer, the system provides you with the opportunity to run this program. Press during the Power-On Self-Test (POST) to enter the Setup utility; otherwise, POST continues with its test routines.

If you wish to enter Setup after POST, restart the system by pressing <Ctrl+Alt+Delete>, or by pressing the reset button on the system chassis. You can also restart by turning the system off and then back on. Do this last option only if the first two failed.

The Setup program is designed to make it as easy to use as possible. Being a menu-driven program, it lets you scroll through the various sub-menus and make your selections from the available options using the navigation keys.



-
- The default BIOS settings for this motherboard apply for most conditions to ensure optimum performance. If the system becomes unstable after changing any BIOS settings, load the default settings to ensure system compatibility and stability. Select the **Load Setup Defaults** item under the Exit Menu. See section 3.9 **Exit Menu**.
 - The BIOS Setup screens shown in this section are for reference purposes only, and may not exactly match what you see on your screen.
 - Visit the ASUS website at www.asus.com to download the latest BIOS file for this motherboard.
-

3.2.1 BIOS menu screen

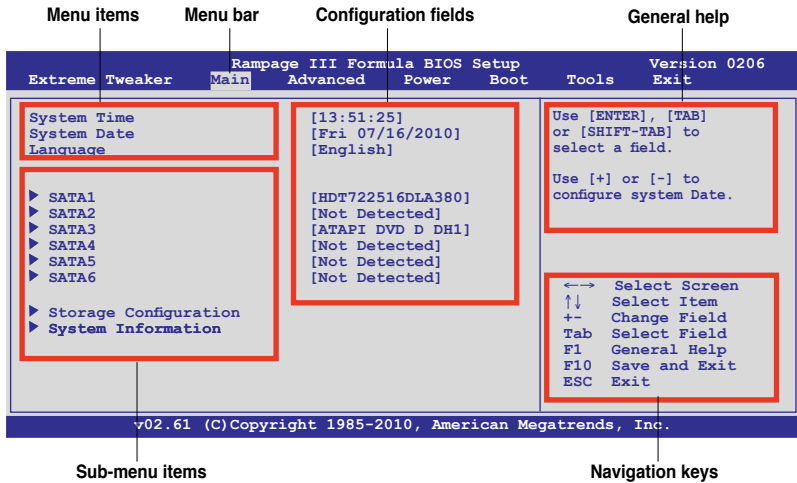

3.2.2 Menu bar

The menu bar on top of the screen has the following main items:

Extreme Tweaker	For changing the overclocking settings
Main	For changing the basic system configuration
Advanced	For changing the advanced system settings
Power	For changing the advanced power management (APM) configuration
Boot	For changing the system boot configuration
Tools	For configuring options for special functions
Exit	For selecting the exit options and loading default settings

3.2.3 Navigation keys

At the bottom right corner of a menu screen are the navigation keys for that particular menu. Use the navigation keys to select items in the menu and change the settings.



Some of the navigation keys differ from one screen to another.

3.2.4 Menu items

The highlighted item on the menu bar displays the specific items for that menu. For example, selecting Main shows the Main menu items.

The other items (Advanced, Power, Boot, and Exit) on the menu bar have their respective menu items.

3.2.5 Submenu items

A solid triangle before each item on any menu screen means that the item has a submenu. To display the submenu, select the item and press <Enter>.

3.2.6 Configuration fields

These fields show the values for the menu items. If an item is user-configurable, you can change the value of the field opposite the item. You cannot select an item that is not user-configurable.

A configurable field is enclosed in brackets, and is highlighted when selected. To change the value of a field, select it then press <Enter> to display a list of options. Refer to 3.2.7 Pop-up window.

3.2.7 Pop-up window

Select a menu item then press <Enter> to display a pop-up window with the configuration options for that item.

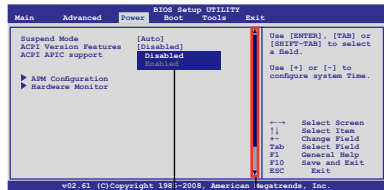

Scroll bar
Pop-up window

3.2.8 Scroll bar

A scroll bar appears on the right side of a menu screen when there are items that do not fit on the screen. Press the Up/Down arrow keys or <Page Up> / <Page Down> keys to display the other items on the screen.

3.2.9 General help

At the top right corner of the menu screen is a brief description of the selected item.

3.3 Extreme Tweaker menu

The Extreme Tweaker menu items allow you to configure overclocking-related items.



Take caution when changing the settings of the **Extreme Tweaker** menu items. Incorrect field values can cause the system to malfunction.



The default values of the following items vary depending on the CPU and memory modules you install on the motherboard.

Rampage III Formula BIOS Setup		Version 0206
Extreme Tweaker	Main Advanced Power Boot	Tools Exit

Configure System Performance Settings Target CPU Frequency: 2793MHZ Target DRAM Frequency: 1066MHZ LN2 Mode: Disabled QPI Loadline Calibration: Disabled CPU Level Up [Auto] ----- Sync mode [Enabled] Ai Overclock Tuner [Auto] CPU Ratio Status: (Min:12, Max:22) CPU Ratio Setting [Auto] CPU Turbo Power Limit [Disabled] ▶ CPU Configuration DRAM Frequency [Auto] UCLK Frequency [Auto] QPI Link Data Rate [Auto] Memory Configuration Protect [Disabled]	Warning: this function belongs to overclocking, and it may cause instability. Select a CPU level, and the rest will be auto-adjusted. If you want to adjust more, set Ai Overclock Tuner to Manual after you select a CPU level. ←→ Select Screen ↑↓ Select Item +- Change Field F1 General Help F10 Save and Exit ESC Exit
--	--

v02.61 (C) Copyright 1985-2010, American Megatrends, Inc.

Scroll down to display the following items:

▶ DRAM Timing Control CPU Differential Amplitude [Auto] CPU Clock Skew [Auto] IOH Clock Skew [Auto] ----- Extreme Engine Digi+ ----- Digi+ PWR Mode [T-Balanced] PWM Volt. Control [Auto] Load-Line Calibration [Auto] CPU Voltage OCP [Enabled] CPU PWM Frequency [Auto] --- Please key in numbers or select voltage! --- Extreme OV [Disabled] Extreme OC [Auto] CPU temp.: 53°C/127°F CPU Voltage 1.230 [Auto] CPU PLL Voltage 1.812 [Auto] QPI/DRAM Core Voltage 1.151 [Auto] DRAM Bus Voltage 1.601 [Auto] ▶ DRAM REF Voltages IOH temp.: 47°C/116.5°F 61°C/141.5°F IOH Voltage 1.111 [Auto] IOH PCIE Voltage 1.508 [Auto] ICH temp.: 61°C/141.5°F ICH Voltage 1.111 [Auto] ICH PCIE Voltage [Auto] ----- O.C. Profile ----- ▶ ASUS O.C. Profile ----- Spread Spectrum Control ----- CPU Spread Spectrum [Auto] PCIE Spread Spectrum [Auto]	←→ Select Screen ↑↓ Select Item +- Change Option F1 General Help F10 Save and Exit ESC Exit
---	--

v02.61 (C) Copyright 1985-2010, American Megatrends, Inc.

3.3.1 CPU Level Up [Auto]

Allows you to select a CPU level, and the related parameters will be automatically adjusted according to the selected CPU level. If you want to manually configure the settings in detail, set **Ai Overclock Tuner** to [Manual] after selecting a CPU level. Configuration options: [Auto] [i7-950-3.06G] [i7-965-3.20G]

3.3.2 Sync Mode [Enabled]

Allows you to enable or disable Sync Mode. Configuration options: [Enabled] [Disabled]

3.3.3 Ai Overclock Tuner [Auto]

Allows selection of CPU overclocking options to achieve desired CPU internal frequency. Select either one of the preset overclocking configuration options:

Manual	Allows you to individually set overclocking parameters.
Auto	Loads the optimal settings for the system.
X.M.P.	If you install memory module(s) supporting the eXtreme Memory Profile (X.M.P.) Technology, choose this item to set the profile(s) supported by your memory module(s) for optimizing the system performance.
CPU Level Up	Allows you to select a CPU level, and the related parameters will be adjusted automatically.
ROG Memory Profile	Allows you to select a memory profile.

eXtreme Memory Profile [Disabled]

This item appears only when you set the **Ai Overclock Tuner** item to [X.M.P.] and allows you to select the X.M.P. mode supported by your memory module. Configuration options: [Enabled] [Disabled]

ROG Memory Profile [Speedy]

This item appears only when you set the **Ai Overclock Tuner** item to [ROG Memory Profile] and allows you to select the X.M.P. mode supported by your memory module. Configuration options: [Speedy] [Flying] [Lighting]



This item may cause system unstable. Select a memory profile and the DDR timing will adjusted automatically.

3.3.4 CPU Ratio Setting [Auto]

Allows you to adjust the ratio between CPU Core Clock and FSB Frequency. Use the <+> and <-> keys to adjust the value. The valid value ranges differently according to your CPU model.

3.3.5 CPU Turbo Power Limit [Disabled]

Allows you to activate or deactivate the CPU Turbo Power Limit. If you want to keep the Turbo mode ratio, remember to disable C1E and TM functions at the same time. Configuration options: [Disabled] [Enabled]

3.3.6 CPU Configuration

The items in this menu show the CPU-related information that the BIOS automatically detects. Refer to **3.5 Advanced menu** for details.



The following two items appear when you set the **Ai Overclock Tuner** item to [X.M.P] or [Manual].

3.3.7 BCLK Frequency [XXX]

Allows you to adjust the Internal Base Clock (BCLK). Use the <+> and <-> keys to adjust the value. You can also type the desired value using the numeric keypad. The values range from 100 to 500.

3.3.8 PCIE Frequency [XXX]

Allows you to adjust the PCI Express frequency. Use the <+> and <-> keys to adjust the value. You can also type the desired value using the numeric keypad. The values range from 100 to 200.

3.3.9 DRAM Frequency [Auto]

Allows you to set the DDR3 operating frequency.

Configuration options: [Auto] [DDR3-800MHz] [DDR3-1066MHz] [DDR3-1333MHz] [DDR3-1600MHz] [DDR3-1866MHz] [DDR3-2133MHz] [DDR3-2400MHz]



For CPU that is locked, only frequency [DDR3-800MHz] or [DDR3-1066MHz] can work.

3.3.10 UCLK Frequency [Auto]

Allows you to adjust the Uncore Clock Ratio.

Configuration options: [Auto] [1600MHz] [1733MHz] [1866MHz] [2000MHz] [2133MHz] [2266MHz] [2400MHz] [2533MHz] [2666MHz] [2800MHz] [2933MHz] [3066MHz] [3200MHz] [3333MHz] [3466MHz]

3.3.11 QPI Link Data Rate [Auto]

Allows you to adjust the QPI link data rate.

Configuration options: [Auto] [Slow Mode] [4800MT/s] [5866MT/s] [6400MT/s]

3.3.12 DRAM Timing Control



The configuration options for some of the following items vary depending on the DIMMs you install on the motherboard.

1st Information:

The values vary depending on your settings of the following sub-items:

CAS# Latency 7 [Auto]

Configuration options: [Auto] [3 DRAM Clock] [4 DRAM Clock] – [10 DRAM Clock] [11 DRAM Clock]

RAS# to CAS# Delay 7 [Auto]

Configuration options: [Auto] [3 DRAM Clock] – [10 DRAM Clock]

RAS# PRE Time 7 [Auto]

Configuration options: [Auto] [3 DRAM Clock] – [10 DRAM Clock]

RAS# ACT Time 20 [Auto]

Configuration options: [Auto] [3 DRAM Clock] [4 DRAM Clock] – [16 DRAM Clock] [17 DRAM Clock]

RAS# to RAS# Delay 4 [Auto]

Configuration options: [Auto] [1 DRAM Clock] – [7 DRAM Clock]

REF Cycle Time 59 [Auto]

Configuration options: [Auto] [30 DRAM Clock] [36 DRAM Clock] [48 DRAM Clock] [60 DRAM Clock] [72 DRAM Clock] [82 DRAM Clock] [88 DRAM Clock] [90 DRAM Clock] [100 DRAM Clock] [110 DRAM Clock]

WRITE Recovery Time 8 [Auto]

Configuration options: [Auto] [1 DRAM Clock] – [15 DRAM Clock]

READ to PRE Time 6 [Auto]

Configuration options: [Auto] [3 DRAM Clock] – [15 DRAM Clock]

FOUR ACT WIN Time 20 [Auto]

Configuration options: [Auto] [1 DRAM Clock] – [63 DRAM Clock]

Back-To-Back CAS# Delay 0 [Auto]

Configuration options: [Auto] [4 DRAM Clock] – [18 DRAM Clock]

2nd Information:

The values vary depending on your settings of the following sub-items:

Timing Mode 1N [Auto]

Configuration options: [Auto] [1N] [2N] [3N]

Round Trip Latency on CHA 46 [Auto]

Configuration options: [Auto] [Advance 15 Clock] – [Advance 1 Clock]

Round Trip Latency on CHB 0 [Auto]

Configuration options: [Auto] [Advance 15 Clock] – [Advance 1 Clock]

Round Trip Latency on CHC 0 [Auto]

Configuration options: [Auto] [Advance 15 Clock] – [Advance 1 Clock]

3rd Information:

The values vary depending on your settings of the following sub-items:

WRITE to READ Delay(DD) 6 [Auto]

Configuration options: [Auto] [1 DRAM Clock] – [8 DRAM Clock]

WRITE to READ Delay(DR) 6 [Auto]

Configuration options: [Auto] [1 DRAM Clock] – [8 DRAM Clock]

WRITE to READ Delay(SR) 14 [Auto]

Configuration options: [Auto] [10 DRAM Clock] – [22 DRAM Clock]

READ to WRITE Delay(DD) 9 [Auto]

Configuration options: [Auto] [2 DRAM Clock] – [14 DRAM Clock]

READ to WRITE Delay(DR) 9 [Auto]

Configuration options: [Auto] [2 DRAM Clock] – [14 DRAM Clock]

READ to WRITE Delay(SR) 9 [Auto]

Configuration options: [Auto] [2 DRAM Clock] – [14 DRAM Clock]

READ to READ Delay(DD) 7 [Auto]

Configuration options: [Auto] [2 DRAM Clock] – [9 DRAM Clock]

READ to READ Delay(DR) 6 [Auto]

Configuration options: [Auto] [2 DRAM Clock] – [9 DRAM Clock]

READ to READ Delay(SR) 4 [Auto]

Configuration options: [Auto] [4 DRAM Clock] [6 DRAM Clock]

WRITE to WRITE Delay(DD) 7 [Auto]

Configuration options: [Auto] [2 DRAM Clock] – [9 DRAM Clock]

WRITE to WRITE Delay(DR) 7 [Auto]

Configuration options: [Auto] [2 DRAM Clock] – [9 DRAM Clock]

WRITE to WRITE Delay(SR) 4 [Auto]

Configuration options: [Auto] [4 DRAM Clock] [6 DRAM Clock]

3.3.13 CPU Differential Amplitude [Auto]

Different AMP might enhance BCLK overclocking ability.

Configuration options: [Auto] [700mV] [800mV] [900mV] [1000mV]

3.3.14 CPU Clock Skew [Auto]

Adjusting this item may help enhancing BCLK overclocking ability. You may need to adjust the IOH Clock Skew item at the same time.

Configuration options: [Auto] [Normal] [Delay 100ps]–[Delay 1500ps]

3.3.15 IOH Clock Skew [Auto]

Adjusting this item may help enhancing BCLK overclocking ability. You may need to adjust the CPU Clock Skew item at the same time.

Configuration options: [Auto] [Normal] [Delay 100ps]–[Delay 1500ps]

3.3.16 Digi+ PWR Mode [T-Balanced]

[X-Power] Unleashes the power system to push the limit for extreme overclcking.

[T-Balanced] Manages to achieve the optimum thermal performance for longer component life.

3.3.17 PWM Volt. Control [Auto]

Allows you to adjust the MOSFET driving voltage.

Configuration options: [Auto] [6V] [7V] [8V] [9V] [10V]

3.3.18 Load-Line Calibration [Auto]

Allows you to select the CPU Load-Line mode.

Configuration options: [Auto] [0% Calibration] [50% Calibration] [Full Calibration]

3.3.19 CPU Voltage OCP [Enabled]

Configuration options: [Disabled] [Enabled]

3.3.20 CPU PWM Frequency [Auto]

Configuration options: [Auto] [250KHz] [500KHz] [750KHz] [1000KHz]

3.3.21 Extreme OV [Disabled]

[Enabled] Enables the Extreme OV function.

[Disabled] Disables this function.

3.3.22 Extreme OC [Disabled]

Configuration options: [Auto] [Mode 1] [Mode 2]

3.3.23 CPU Voltage [Auto]

Allows you to set the CPU voltage. The values range from 0.85000V to 2.30000V with a 0.00625V interval.



Refer to the CPU documentation before setting the CPU Vcore voltage. Setting a high VCore voltage may damage the CPU permanently, and setting a low VCore voltage may make the system unstable.

3.3.24 CPU PLL Voltage [Auto]

Allows you to set the CPU PLL voltage. The values range from 1.20575V to 2.05375V with a 0.01325V interval.

3.3.25 QPI/DRAM Core Voltage [Auto]

Allows you to set the QPI/DRAM core voltage. The values range from 1.20000V to 2.50000V with a 0.00625V interval.

3.3.26 DRAM Bus Voltage [Auto]

Allows you to set the DRAM voltage. The values range from 1.20575V to 2.50425V with a 1.01325V interval.

3.3.27 DRAM REF Voltages

DRAM DATA REF Voltage on CHA/B/C [Auto]

Allows you to set the DRAM DATA Reference Voltage on Channel A/B/C. The values range from -157.5mV to +200mV with a 12.5mV interval. Different ratio might enhance DRAM overclocking ability.

DRAM CTRL REF Voltage on CHA/B/C [Auto]

Allows you to set the DRAM Control Reference Voltage on Channel A/B/C. The values range from -157.5mV to +200mV with a 12.5mV interval. Different ratio might enhance DRAM overclocking ability.

3.3.28 IOH Voltage [Auto]

Allows you to set the IOH voltage. The values range from 1.11300V to 1.90800V with a 0.01325V interval.

3.3.29 IOH PCIE Voltage [Auto]

Allows you to set the IOH voltage. The values range from 1.51050V to 2.78250V with a 0.01325V interval.

3.3.30 ICH Voltage [Auto]

Allows you to set the ICH voltage. The values range from 1.11300V to 2.00075V with a 0.01325V interval.

3.3.31 ICH PCIE Voltage [Auto]

Allows you to set the ICH voltage. The values range from 1.51050V to 2.05375V with a 0.01325V interval.

3.3.32 ASUS O.C. Profile

Refer to **3.8 Tools Menu** for details

3.3.33 CPU Spread Spectrum [Auto]

[Disabled] Enhances the BCLK overclocking ability.

[Auto] Sets to [Auto] for EMI control.

3.3.34 PCIE Spread Spectrum [Auto]

[Disabled] Enhances the PCIE overclocking ability

[Auto] Sets to [Auto] for EMI control.

3.4 Main menu

When you enter the BIOS Setup program, the Main menu screen appears, giving you an overview of the basic system information.



Refer to section **3.2.1 BIOS menu screen** for information on the menu screen items and how to navigate through them.

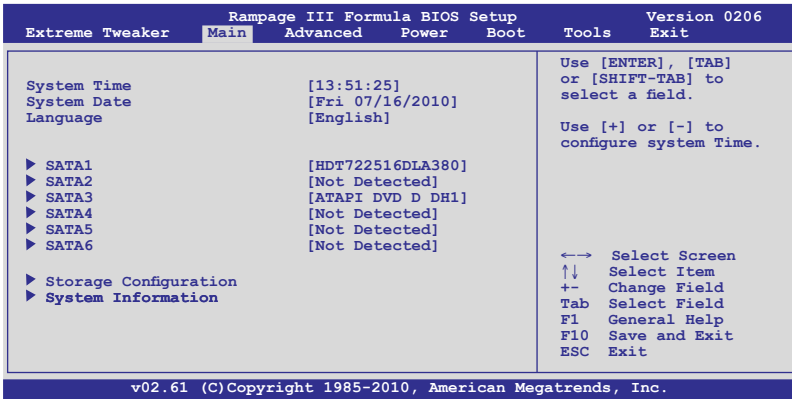

3.4.1 System Time [xx:xx:xx]

Allows you to set the system time.

3.4.2 System Date [Day xx/xx/xxxx]

Allows you to set the system date.

3.4.3 Language [English]

Allows you to choose the BIOS language version from the options.

Configuration options: [繁體中文] [簡體中文] [日本語] [Français] [Deutsch] [English]

3.4.4 SATA 1-6

While entering Setup, the BIOS automatically detects the presence of Serial ATA devices. There is a separate sub-menu for each SATA device. Select a device item then press <Enter> to display the SATA device information.

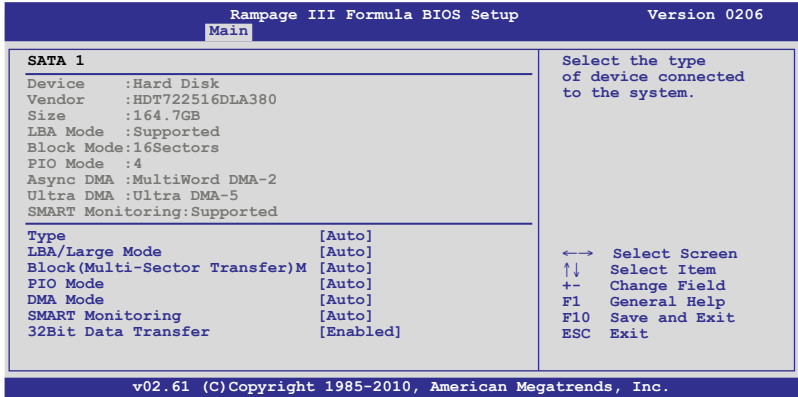

The BIOS automatically detects the values opposite the dimmed items (Device, Vendor, Size, LBA Mode, Block Mode, PIO Mode, Async DMA, Ultra DMA, and SMART monitoring). These values are not user-configurable. These items show [Auto] if no IDE device is installed in the system.

Type [Auto]

Allows you to select the type of IDE drive installed.

[Not Installed] Select this option if no IDE drive is installed.

[Auto] Allows automatic selection of the appropriate IDE device type.

[CDROM] Select this option if you are specifically configuring a CD-ROM drive.

[ARMD] Select [ARMD] (ATAPI Removable Media Device) if your device is either a ZIP, LS-120, or MO drive.

LBA/Large Mode [Auto]

Enables or disables the LBA (Logical Block Addressing) mode.

[Auto] Select [Auto] to enable the LBA mode (Logical Block Addressing mode) if the device supports this mode, and if the device was not previously formatted with LBA mode disabled.

[Disabled] Disable this function.

Block (Multi-Sector Transfer) M [Auto]

Enables or disables data multi-sectors transfers.

[Auto] When set to [Auto], the data transfer from and to the device occurs multiple sectors at a time if the device supports multi-sector transfer feature.

[Disabled] When set to [Disabled], the data transfer from and to the device occurs one sector at a time.

PIO Mode [Auto]

[Auto] Allows automatic selection of the PIO (Programmed input/output) modes, which correspond to different data transfer rates.

[0] [1] – [4] Set the PIO mode to Mode 0, 1, 2, 3, or 4.

DMA Mode [Auto]

DMA (Direct Memory Access) allows your computer to transfer data to and from the hardware devices installed with much less CPU overhead.

The DMA mode consists of SDMA (single-word DMA), MDMA (multi-word DMA), and UDMA (Ultra DMA). Setting to [Auto] allows automatic selection of the DMA mode, or you can select from the following options: [SWDMA1] [SWDMA2] [MWDMA0] [MWDMA1] [MWDMA2] [UDMA0] [UDMA1] [UDMA2] [UDMA3] [UDMA4] [UDMA5]

SMART Monitoring [Auto]

[Auto] Allows automatic selection of the S.M.A.R.T (Smart Monitoring, Analysis, and Reporting Technology).

[Enabled] Enable the S.M.A.R.T feature.

[Disabled] Disable the S.M.A.R.T feature.

32Bit Data Transfer [Enabled]

[Enabled] Sets the IDE controller to combine two 16-bit reads from the hard disk into a single 32-bit double word transfer to the processor. This makes more efficient use of the PCI bus as fewer transactions are needed for the transfer of a particular amount of data.

[Disabled] Disable this function.

3.4.5 Storage Configuration

The items in this menu allow you to set or change the configurations for the SATA devices installed in the system. Select an item then press <Enter> if you want to configure the item.

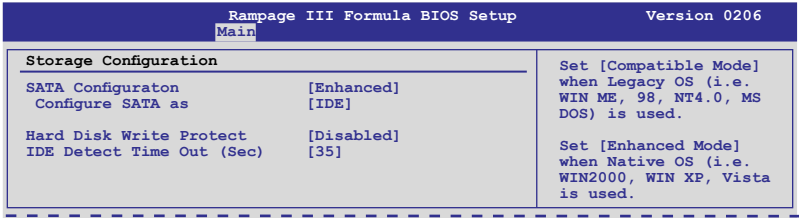

SATA Configuration [Enhanced]

Configuration options: [Disabled] [Compatible] [Enhanced]

Configure SATA as [IDE]

Sets the configuration for the Serial ATA connectors supported by the Southbridge chip. Configuration options: [IDE] [RAID] [AHCI]



- If you want to use the Serial ATA hard disk drives as Parallel ATA physical storage devices, keep the default setting [IDE].
- If you want the Serial ATA hard disk drives to use the Advanced Host Controller Interface (AHCI), set this item to [AHCI]. The AHCI allows the onboard storage driver to enable advanced Serial ATA features that increases storage performance on random workloads by allowing the drive to internally optimize the order of commands.
- If you want to create a RAID 0, RAID 1, RAID 5, RAID 10, or the Intel® Matrix Storage Technology configuration from the Serial ATA hard disk drives, set this item to [RAID].

Hard Disk Write Protect [Disabled]

Disables or enables device write protection. This will be effective only if the device is accessed through BIOS. Configuration option: [Disabled] [Enabled]

IDE Detect Time Out (Sec) [35]

Selects the time out value for detecting ATA/ATAPI devices. Configuration options: [0] [5] [10] [15] [20] [25] [30] [35]

3.4.6 AHCI Configuration

This menu is the section for AHCI configuration. It appears only when you set the item **Configure SATA as** from the sub-menu of **SATA Configuration** to [AHCI].

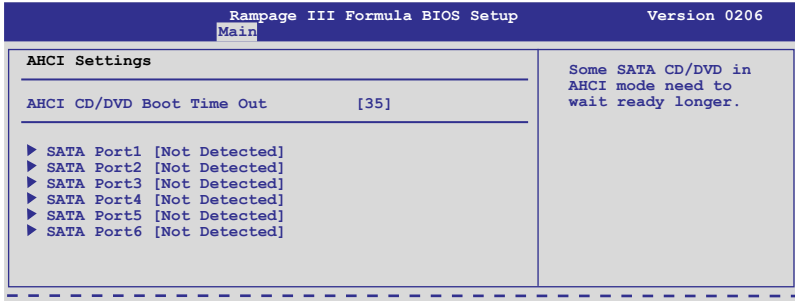

AHCI CD/DVD Boot Time out [35]

Configuration options: [0] [5] [10] [15] [20] [25] [30] [35]

SATA Port1-6 [XXXX]

Displays the status of auto-detection of SATA devices.

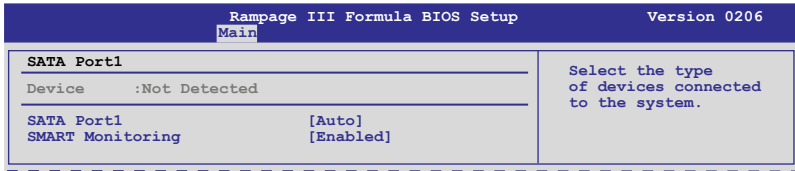

SATA Port1 [Auto]

Allows you to select the type of device connected to the system.

Configuration options: [Auto] [Not Installed]

SMART Monitoring [Enabled]

Allows you to set the Self-Monitoring, Analysis and Reporting Technology.

Configuration options: [Disabled] [Enabled]

3.4.7 System Information

This menu gives you an overview of the general system specifications. The BIOS automatically detects the items in this menu.

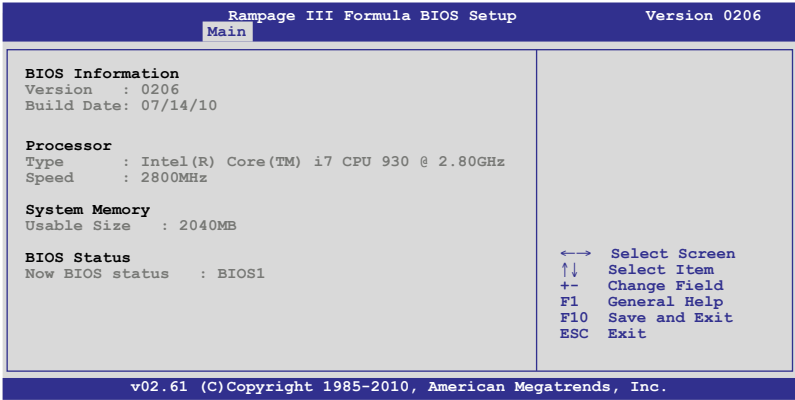

3.5 Advanced menu

The Advanced menu items allow you to change the settings for the CPU and other system devices.

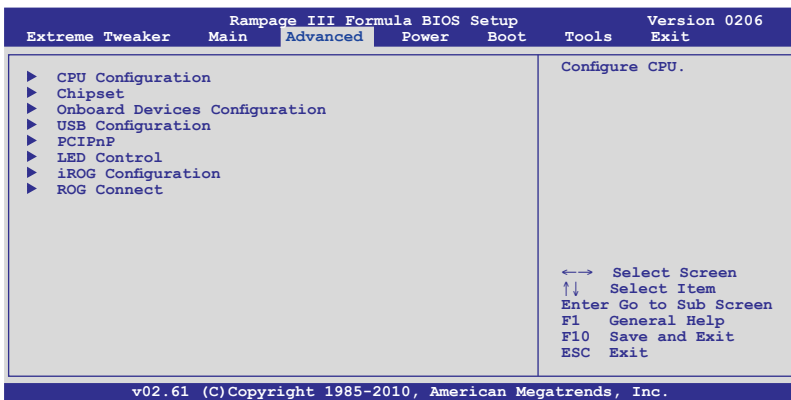

3.5.1 CPU Configuration

The items in this menu show the CPU-related information that the BIOS automatically detects.



The items shown in this screen may be different due to the CPU you installed.

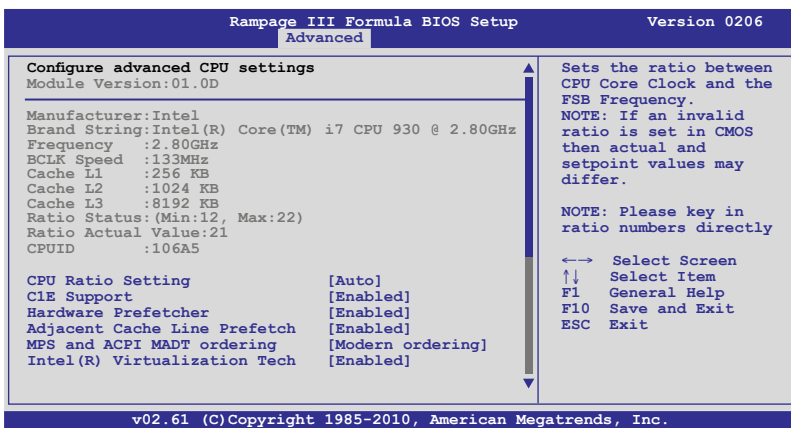

Scroll down to display the following items:

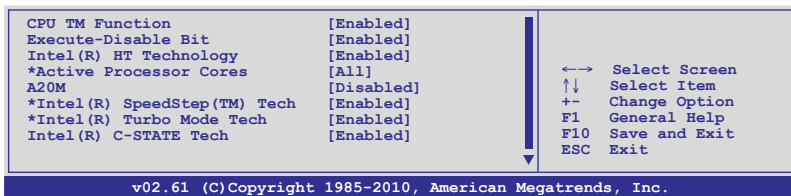

CPU Ratio Setting [Auto]

Allows you to adjust the ratio between CPU Core Clock and BCLK Frequency. Use the <+> and <-> keys to adjust the value. The valid value ranges differently according to your CPU model.

C1E Support [Disabled]

[Enabled] Enables the C1E support function. This item should be enabled in order to enable the Enhanced Halt State.

[Disabled] Disables this function.

Hardware Prefetcher [Enabled]

[Enabled] Enables the Hardware Prefetcher function. This item should be enabled in order to enable the L2 cache (MLC) Streamer Prefetcher for tuning performance of the specific application.

[Disabled] Disables this function.

Adjacent Cache Line Prefetcher [Enabled]

[Enabled] Enables the Adjacent Cache Line Prefetcher function. This item should be enabled in order to enable the L2 cache (MLC) Spatial Prefetcher for tuning performance of the specific application.

[Disabled] Disables this function.

MPS and ACPI MADT ordering [Modern ordering]

[Modern ordering] For Windows XP or later version operating systems.

[Legacy ordering] Windows 2000 or earlier version operating systems.

Intel(R) Virtualization Tech [Enabled]

[Enabled] Allows a hardware platform to run multiple operating systems separately and simultaneously, enabling one system to virtually function as several systems.

[Disabled] Disables this function.

CPU TM Function [Enabled]

[Enabled] Enables the overheated CPU to throttle its clock speed to cool down.

[Disabled] Disables this function.

Execute Disable Bit [Enabled]

[Enabled] Enables the No-Execution Page Protection Technology.

[Disabled] Forces the XD feature flag to always return to zero (0).

Intel(R) HT Technology [Enabled]

[Enabled] Enables the Intel Hyper-Threading Technology.

[Disabled] Only one thread per activated CPU core is enabled.

Active Processor Cores [All]

- [All] Activate all CPU cores in the processor package.
- [1] Activate only 1 CPU core in the processor package.
- [2] Activate 2 CPU cores in the processor package.

A20M [Disabled]

- [Enabled] Legacy OSeS and APs may need this function enabled.
- [Disabled] Disables this function.

Intel(R) SpeedStep (TM) Tech [Enabled]

- [Enabled] The CPU speed is controlled by the operating system.
- [Disabled] The CPU runs at its default speed.

Intel(R) Turbo Mode Tech [Enabled]

- [Enabled] Allows the processor cores to run faster than the marked frequency in specific condition.
- [Disabled] Disables this function.

Intel(R) C-STATE Tech [Disabled]

- [Enabled] Allows the CPU to save more power under idle mode. Enable this item only when you install a C-State Technology-supported CPU.
- [Disabled] Disables this function.

C State package limit setting [Auto]

This item appears only when you set the **Intel(R) C-STATE Tech** item to [Enabled]. We recommend that you set this item to [Auto] for BIOS to automatically detect the C-State mode supported by your CPU. Configuration options: [Auto] [C1] [C3] [C6]

C1 Auto Demotion [Enabled]

This item appears only when you set the **Intel(R) C-STATE Tech** item to [Enabled]. When this item is enabled, the CPU will conditionally demote C3/C6/C7 requests to C1 based on uncore auto-demote information.

C3 Auto Demotion [Enabled]

This item appears only when you set the **Intel(R) C-STATE Tech** item to [Enabled]. When this item is enabled, the CPU will conditionally demote C6/C7 requests to C3 based on uncore auto-demote information.

3.5.2 Chipset

The Chipset menu allows you to change the advanced chipset settings. Select an item then press <Enter> to display the sub-menu.

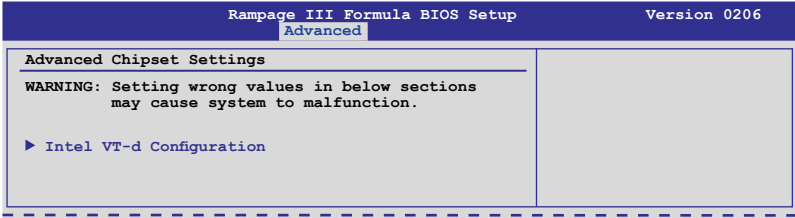

Intel VT-d Configuration

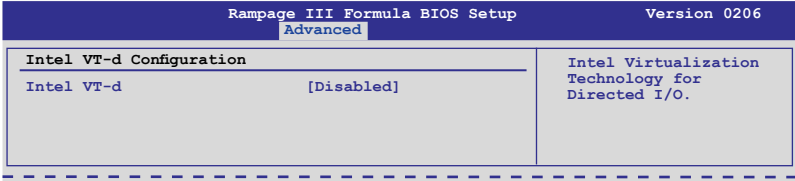

Intel VT-d [Disabled]

Enables or disables the Intel Virtualization technology for directed I/O.

3.5.3 Onboard Devices Configuration

Rampage III Formula BIOS Setup		Version 0206
Advanced		
Onboard Device Configuration		
Onboard Device	[Standard]	Get your best overclocking record! "Onboard Device" is to disable all the unnecessary devices when you want to reach your best overclocking record. But it will keep 1 lan port alive to submit your score.
High Definition Audio	[Enabled]	
Front Panel Type	[HD Audio]	
SPDIF OUT Mode Setting	[SPDIF]	
Onboard SATA Controller	[Enabled]	
GbE Controller	[Enabled]	
GbE LAN Boot	[Disabled]	
GbE Wake Up From S5	[Disabled]	
Onboard 1394 Controller	[Enabled]	
Onboard SATA6G Controller	[IDE Mode]	
Onboard USB 3.0 Controller	[Enabled]	

High Definition Audio [Enabled]

[Enabled] Enables the High Definition Audio Controller.

[Disabled] Disables the controller.

Front Panel Type [HD Audio]

[AC97] Set the front panel audio connector (AAFP) mode to legacy AC'97

[HD Audio] Set the front panel audio connector (AAFP) mode to high-definition audio.

SPDIF OUT Mode Setting [SPDIF]

[SPDIF] Set the SPDIF OUT mode to SPDIF.

[HDMI] Set the SPDIF OUT mode to HDMI.

Onboard SATA Controller [Enabled]

[Disabled] Disables the SATA controller of SATA_E1.

[IDE Mode] Enables the SATA controller of SATA_E1.

GbE Controller [Enabled]

[Enabled] Enables Gbe LAN Controller.

[Disabled] Disables Gbe LAN Controller.

GbE LAN Boot [Disabled]

This item appears only when you enable the previous item(s).

[Disabled] Disables GbE LAN Boot.

[Enabled] Enables GbE LAN Boot.

GbE Wake Up From S5 [Disabled]

This item appears only when you enable the previous item(s).

[Disabled] Disables GbE to wake up from S5.

[Enabled] Enables GbE to wake up from S5.

Onboard 1394 Controller [Enabled]

[Enabled] Enables the onboard 1394 Controller.

[Disabled] Disables the controller.

Onboard SATA6G Controller [IDE Mode]

- [Disabled] Disables the onboard SATA6G controller.
- [IDE Mode] Set to [IDE Mode] when you want to use the Serial ATA hard disk drives as Parallel ATA physical storage devices.
- [AHCI Mode] Set to [AHCI] when you want the SATA hard disk drives to use the AHCI (Advanced Host Controller Interface). The AHCI allows the onboard storage driver to enable advanced Serial ATA features that increases storage performance on random workloads by allowing the drive to internally optimize the order of commands.

Onboard USB 3.0 Controller [Enabled]

- [Enabled] Enables the onboard USB 3.0 Controller.
- [Disabled] Disables the controller.

3.5.4 USB Configuration

The items in this menu allows you to change the USB-related features. Select an item then press <Enter> to display the configuration options.

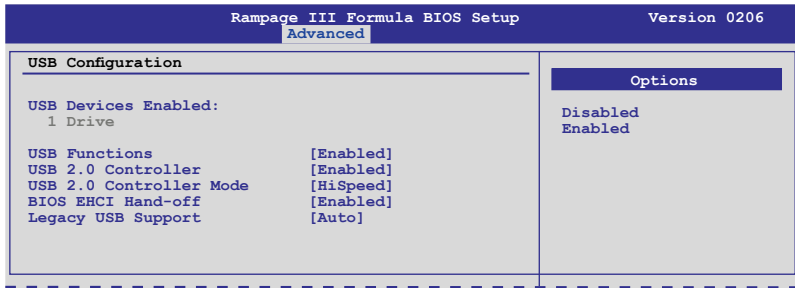

The **USB Devices Enabled** item shows the auto-detected values. If no USB device is detected, the item shows None.

USB Functions [Enabled]

[Enabled] Enables the USB Host Controllers.

[Disabled] Disables the controllers.



The following items appear only when you set **USB Functions** to [Enabled].

USB 2.0 Controller [Enabled]

[Enabled] Enables the USB 2.0 Controllers.

[Disabled] Disables the controllers.

USB 2.0 Controller Mode [HiSpeed]

[FullSpeed] Sets the USB 2.0 Controller in full speed (12Mbps).

[HiSpeed] Sets the USB 2.0 Controller in high speed (480Mbps).

BIOS EHCI Hand-off [Enabled]

[Enabled] Enables the support for operating systems without an EHCI hand-off feature.

[Disabled] Disables the function.

Legacy USB Support [Auto]

[Auto] Allows the system to detect the presence of USB devices at startup. If detected, the USB controller legacy mode is enabled. If no USB device is detected, the legacy USB support is disabled.

[Enabled] Enables the support for USB devices on legacy operating systems (OS).

[Disabled] Disables the function.

3.5.5 PCIPnP

The PCIPnP menu items allow you to change the advanced settings for PCI/PnP devices.

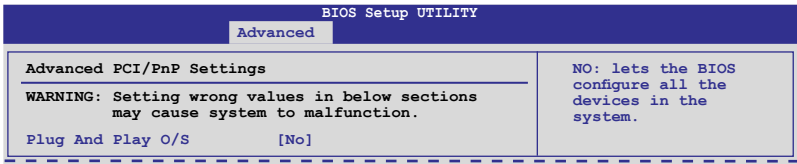

Plug And Play O/S [No]

- [Yes] When set to [Yes] and if you install a Plug and Play operating system, the operating system configures the Plug and Play devices not required for boot.
- [No] When set to [No], BIOS configures all the devices in the system.

3.5.6 LED Control

The LED Control menu items allow you to change the advanced settings for the onboard LEDs.



Take caution when changing the settings of the LED Control menu items. Incorrect field values can cause the system to malfunction.

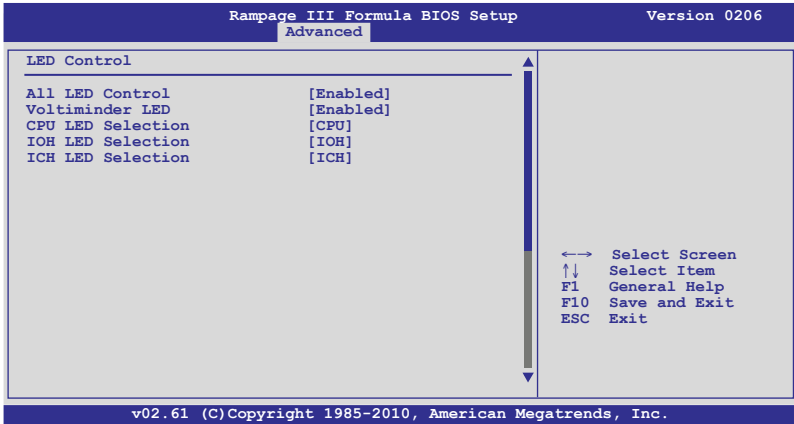

All LED Control [Enabled]

Allows you to enable or disable the onboard LEDs control.

Configuration options: [Enabled] [Disabled]



The following items appear only when you set **All LED Control** to [Enabled].

Voltiminder LED [Enabled]

Allows you to enable or disable the onboard Voltiminder LED.

Configuration options: [Enabled] [Disabled]

CPU LED Selection [CPU]

Allows you to switch the onboard CPU LED display between CPU voltage [CPU], CPU PLL voltage [CPU PLL] and QPI/DRAM core voltage [QPI/DRAM Core].

Configuration options: [CPU] [CPU PLL] [QPI/DRAM Core]

IOH LED Selection [IOH]

Allows you to switch the onboard IOH LED display between IOH voltage [IOH], and IOH PCIE voltage [IOH PCIE]. Configuration options: [IOH] [IOH PCIE]

ICH LED Selection [ICH]

Allows you to switch the onboard ICH LED display between ICH voltage [ICH], and ICH PCIE voltage [ICH PCIE]. Configuration options: [ICH] [ICH PCIE]

3.5.7 iROG Configuration

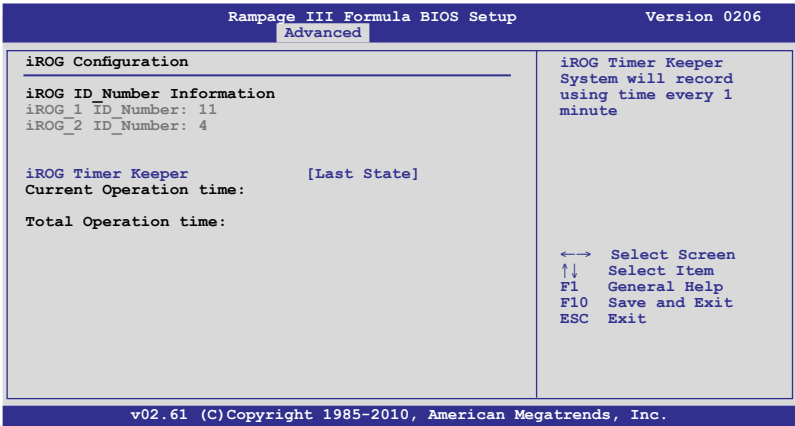

iROG Timer Keeper [Last State]

Allows you to set the iROG Time Keeper operation mode.
Configuration options: [Last State] [Disabled] [Enabled]

3.5.8 ROG Connect

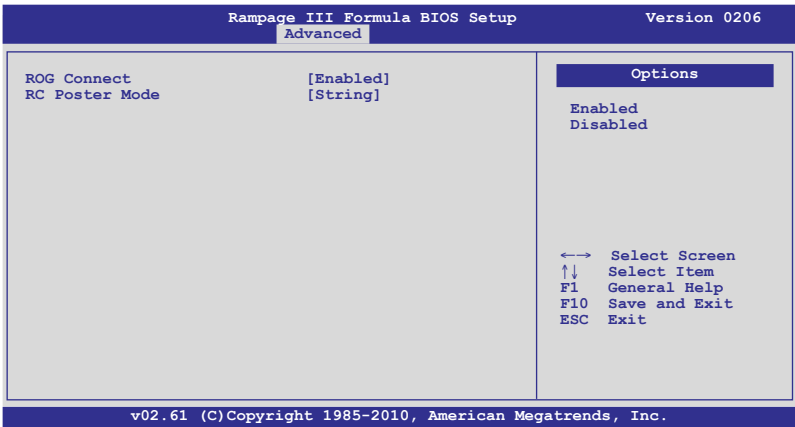

ROG Connect [Enabled]

Allows you to enable or disable the ROG Connect function.
Configuration options: [Enabled] [Disabled]

RC Poster Mode [String]

RC Poster describes what occurs during the POST.
Configuration options: [String] [Code]

3.6 Power menu

The Power menu items allow you to change the settings for the Advanced Power Management (APM). Select an item then press <Enter> to display the configuration options.

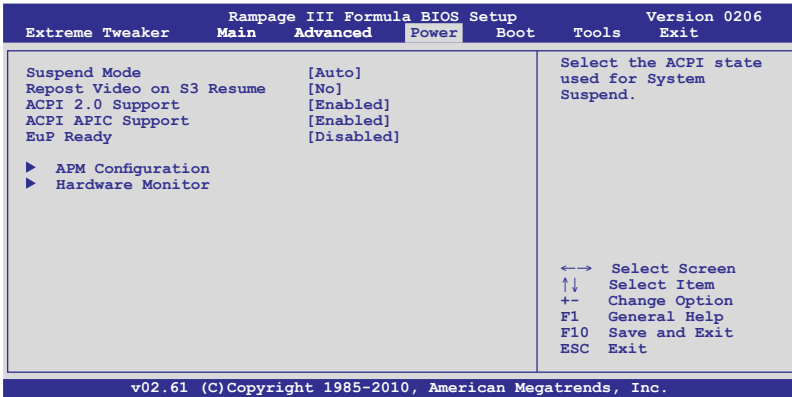

3.6.1 Suspend Mode [Auto]

Allows you to select the Advanced Configuration and Power Interface (ACPI) state to be used for system suspend.

[S1 (POS) only] Sets the ACPI suspend mode to S1/POS (Power On Suspend).

[S3 only] Sets the ACPI suspend mode to S3/STR (Suspend To RAM).

[Auto] The system automatically configures the ACPI suspend mode.

3.6.2 Repost Video on S3 Resume [No]

Determines whether to invoke VGA BIOS POST on S3/STR resume.

[No] When set to [No], the system will not invoke VGA BIOS POST on S3/STR resume.

[Yes] When set to [Yes], the system invokes VGA BIOS POST on S3/STR resume.

3.6.3 ACPI 2.0 Support [Enabled]

[Disabled] When set to [Disabled], the system will not add additional tables as per ACPI 2.0 specifications.

[Enabled] When set to [Enabled], the system adds additional tables as per ACPI 2.0 specifications.

3.6.4 ACPI APIC Support [Enabled]

Allows you to enable or disable the Advanced Configuration and Power Interface (ACPI) support in the Advanced Programmable Interrupt Controller (APIC).

[Disabled] When set to [Disabled], the system disable the Advanced Configuration and Power Interface (ACPI) support in the Advanced Programmable Interrupt Controller (APIC).

[Enabled] When set to [Enabled], the ACPI APIC table pointer is included in the RSDT pointer list.

3.6.5 EuP Ready [Disabled]

[Disabled] Disables the Energy Using Products (EuP) Ready function.

[Enabled] Allows BIOS to switch off some power at S5 state to get system ready for the EuP requirement. When set to [Enabled], power for WOL, WO_USB, audio and onboard LEDs will be switched off at S5 state.

3.6.6 APM Configuration

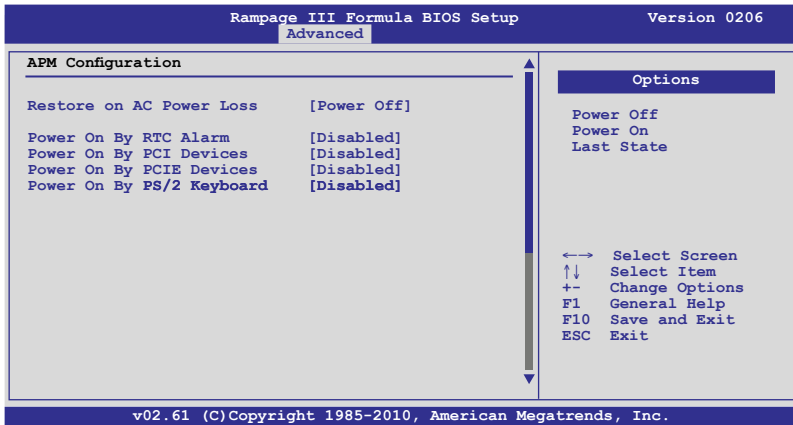

Restore On AC Power Loss [Power Off]

[Power Off] The system goes into off state after an AC power loss.

[Power On] The system goes into on state after an AC power loss.

[Last State] The system goes into either off or on state, whatever the system state was before the AC power loss.

Power On By RTC Alarm [Disabled]

Allows you to enable or disable RTC to generate a wake event. When this item is set to [Enabled], the items **RTC Alarm Date/ RTC Alarm Hour/ RTC Alarm Minute/ RTC Alarm Second** will become user-configurable with set values. Configuration options: [Disabled] [Enabled]

[Disabled] Disables RTC to generate a wake event.

[Enabled] When set to [Enabled], the items **RTC Alarm Date/ RTC Alarm Hour/ RTC Alarm/ RTC Alarm Second** will become user-configurable with set values.

Power On By PCI Devices [Disabled]

[Disabled] Disables the PME to wake up from S5 by PCI devices.

[Enabled] Allows you to turn on the system through a PCI LAN or modem card. This feature requires an ATX power supply that provides at least 1A on the +5VSB lead.

Power On By PCIE Devices [Disabled]

Allows you to enable or disable the PCIE devices to generate a wake event.

[Disabled] Disables the PCIE devices to generate a wake event.

[Enabled] Enables the PCIE devices to generate a wake event.

Power On By PS/2 Keyboard [Disabled]

Allows you to disable or enable the Power On by PS/2 keyboard function.

[Disabled] Disables the Power On by PS/2 keyboard function.

[Enabled] Sets specific keys on the PS/2 keyboard to turn on the system. This feature requires an ATX power supply that provides at least 1A on the +5VSB lead.

3.6.7 Hardware Monitor

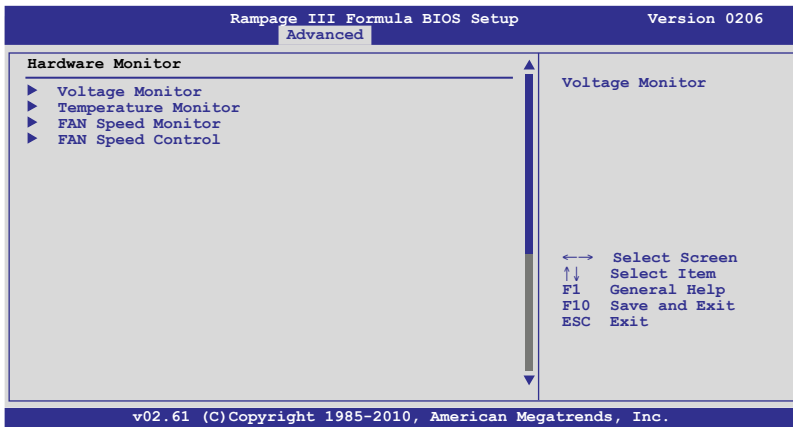

Voltage Monitor

CPU Voltage; CPU PLL Voltage; QPI/DRAM Voltage; IOH Voltage; IOH PCIe Voltage; ICH Voltage; ICH PCIe Voltage; DRAM Bus Voltage; 3.3V Voltage; 5V Voltage; 12V Voltage

The onboard hardware monitor automatically detects the voltage output through the onboard voltage regulators.

Temperature Monitor

CPU Temperature; MB Temperature; IOH Temperature; ICH Temperature; OPT TEMP 1/2/3 [xxx°C/xxx°F]

The onboard hardware monitor automatically detects and displays the CPU, IOH/ICH, motherboard, power, and the assigned devices temperatures. Select [Ignored] if you do not wish to display the detected temperatures.

IOH/ICH overheat protection [100°C]

The system automatically shuts down when the IOH/ICH is heated over the set temperature to protect it from damage.

Configuration options: [Disabled] [70°C] [80°C] [90°C] [100°C]

OPT TEMP1/2/3 overheat protection [90°C]

Allows you to set the temperature over which the system automatically shuts down when any of the thermal sensor cables connected to the motherboard detects device overheat to protect the device from damage.

Configuration options: [Disabled] [70°C] [80°C] [90°C] [100°C]

Fan Speed Monitor

*CPU FAN; Chassis FAN1/2/3; Power FAN Speed
OPT FAN1/2/3 Speed [xxxxRPM] or [Ignored] / [N/A]*

The onboard hardware monitor automatically detects and displays the CPU fan, chassis fan, power fan, and optional fan speed in rotations per minute (RPM). If any of the fans is not connected to the motherboard, the field shows [N/A]. These items are not user-configurable.

Fan Speed Control

Rampage III Formula BIOS Setup		Version 0206
Power		
Fan Speed Control		
CPU Q-Fan Control	[Disabled]	Disable/Enable Q-Fan functions of CPU fan
Chassis Q-Fan Control	[Disabled]	
PWRFAN Control	[Disabled]	
OPTFAN1 Control	[Disabled]	
OPTFAN2 Control	[Disabled]	
OPTFAN3 Control	[Disabled]	

CPU Q-Fan Control [Disabled]

Allows you to enable or disable the CPU fan controller.

- [Disabled] Disables the CPU Q-fan controller.
[Enabled] Enables the CPU Q-fan controller.



The **CPU Fan Profile** item appears when you enable the CPU Fan Control feature.

CPU Fan Profile [Standard]

This item appears only when you enable the **CPU Q-Fan Control** feature and allows you to set the appropriate performance level of the CPU fan.

- [Standard] Sets to [Standard] to make the CPU fan automatically adjust depending on the CPU temperature.
[Silent] Sets to [Silent] to minimize the fan speed for quiet CPU fan operation.
[Turbo] Set to [Turbo] to achieve maximum CPU fan speed.

Chassis Q-Fan Control [Disabled]

Allows you to enable or disable the Chassis fan controller.

- [Disabled] Disables the Chassis Q-fan controller.
[Enabled] Enables the Chassis Q-fan controller.



The **Chassis Fan Profile** item appears when you enable the **Chassis Q-Fan Function** feature.

Chassis Fan Profile [Standard]

This item appears only when you enable the **Chassis Q-Fan Control** feature and allows you to set the appropriate performance level of the chassis fan.

- [Standard] Sets to [Standard] to make the chassis fan automatically adjust depending on the chassis temperature.
- [Silent] Sets to [Silent] to minimize the fan speed for quiet chassis fan operation.
- [Turbo] Set to [Turbo] to achieve maximum chassis fan speed.

PWRFan Control [Disabled]

Allows you to select the power fan control mode. When this item is set to [Duty Mode], you can configure the **PWRFan Duty** item.

PWRFan Duty [60%]

Allows you to set the fan duty cycle. This item appears when the **PWRFan Control** item is set to [Duty Mode].

Configuration options: [40%] [50%] [60%] [70%] [80%] [90%]

OPTFan1/2/3 Control [Disabled]

Allows you to select the optional fan control mode. When this item is set to [Duty Mode], you can configure the **OPTFan1/2/3 Duty** item. If you set this item to [User Mode], you are allowed to configure the **OPTFan1/2/3 Low Speed Temp** and **OPTFan1/2/3 Full Speed Temp** item.

Configuration options: [Disabled] [Duty Mode] [User Mode]



You need to connect the thermal sensor cables to the OPT_TEMP1/2/3 connectors to enable this function.

OPTFan1/2/3 Duty [60%]

Allows you to set the fan duty cycle. This item appears when the **OPTFan1/2 Control** item is set to [Duty Mode].

Configuration options: [40%] [50%] [60%] [70%] [80%] [90%]

OPTFan1/2/3 Low Speed Temp [25°C]

Allows you to set the temperature at which the power fan rotates at low speed. This item appears when the **OPTFan1/2 Control** item is set to [User Mode].

Configuration options: [25°C] [30°C] [35°C] [40°C]

OPTFan1/2/3 Full Speed Temp [60°C]

Allows you to set the temperature at which the power fan rotates at full speed. This item appears when the **OPTFan1/2 Control** item is set to [User Mode].

Configuration options: [60°C] [70°C] [80°C] [90°C]

3.7 Boot menu

The Boot menu items allow you to change the system boot options. Select an item then press <Enter> to display the sub-menu.

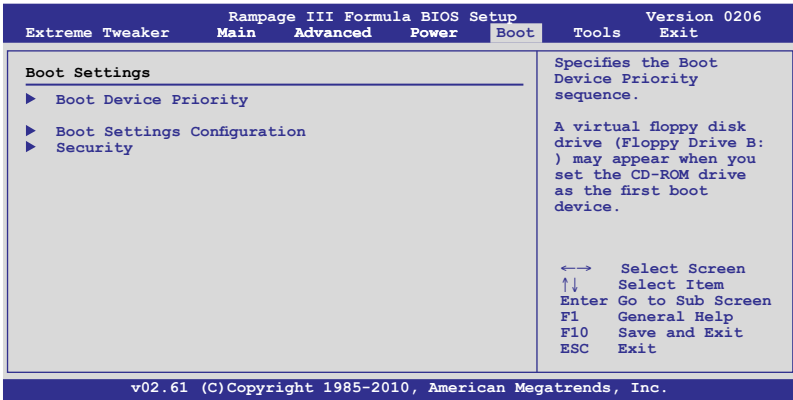

3.7.1 Boot Device Priority

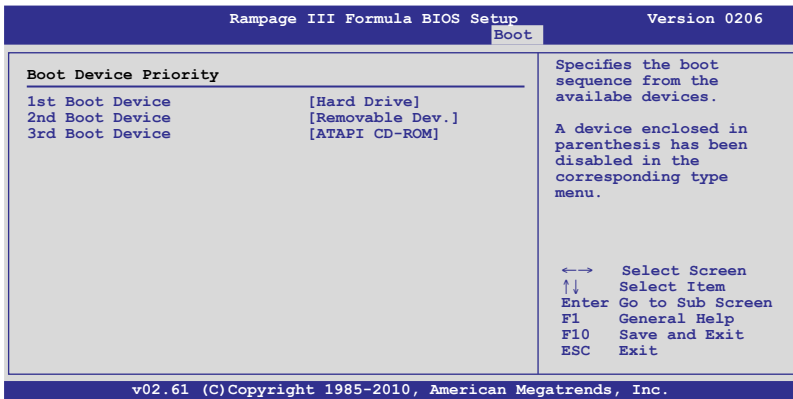

1st–xxth Boot Device [xxx Drive]

These items specify the boot device priority sequence from the available devices. The number of device items that appears on the screen depends on the number of devices installed in the system. Configuration options: [xxx Drive] [Disabled]

3.7.2 Boot Settings Configuration

Rampage III Formula BIOS Setup		Version 0206
Boot		
Boot Settings Configuration		
Quick Boot	[Enabled]	Allows BIOS to skip certain tests while booting. This will decrease the time needed to boot the system.
Full Screen Logo	[Enabled]	
AddOn ROM Display Mode	[Force BIOS]	
Bootup Num-Lock	[On]	
Wait for 'F1' If Error	[Enabled]	
Hit 'DEL' Message Display	[Enabled]	

Quick Boot [Enabled]

Allows you to enable or disable the **Quick Boot** function.

- [Disabled] When set to [Disabled], BIOS performs all the POST items.
- [Enabled] When set to [Enabled], BIOS skips some power on self tests (POST) while booting to decrease the time needed to boot the system.

Full Screen Logo [Enabled]

This allows you to enable or disable the full screen logo display feature.

- [Enabled] Enables the full screen logo display feature.
- [Disabled] Disables the full screen logo display feature.



Set this item to [Enabled] to use the ASUS MyLogo3™ feature.

AddOn ROM Display Mode [Force BIOS]

Sets the display mode for option ROM.

- [Force BIOS]
- [Keep Current] .

Bootup Num-Lock [On]

Allows you to select the power-on state for the NumLock.

- [On] Sets the power-on state of the NumLock to [On].
- [Off] Sets the power-on state of the NumLock to [Off].

Wait for 'F1' If Error [Enabled]

When set to [Enabled], the system waits for the <F1> key to be pressed when error occurs.

Hit 'DEL' Message Display [Enabled]

When set to [Enabled], the system displays the message "Press DEL to run Setup" during POST.

3.7.3 Security

The Security menu items allow you to change the system security settings. Select an item then press <Enter> to display the configuration options.

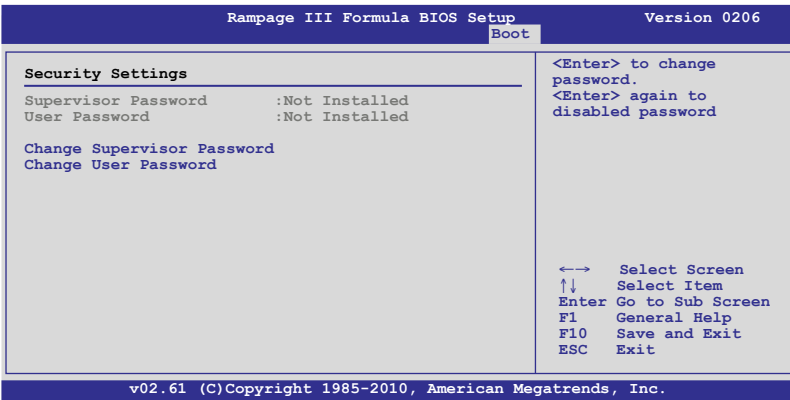

Change Supervisor Password

Select this item to set or change the supervisor password. The Supervisor Password item on top of the screen shows the default **Not Installed**. After you set a password, this item shows Installed.

To set a Supervisor Password:

1. Select the **Change Supervisor Password** item and press <Enter>.
2. From the password box, type a password composed of at least six letters and/or numbers, then press <Enter>.
3. Confirm the password when prompted.

The message **Password Installed** appears after you successfully set your password.

To change the supervisor password, follow the same steps as in setting a user password.

To clear the supervisor password, select the **Change Supervisor Password** then press <Enter>. The message **Password Uninstalled** appears.



If you forget your BIOS password, you can clear it by erasing the CMOS Real Time Clock (RTC) RAM. See section **2.6 Jumper** for information on how to erase the RTC RAM.

After you have set a supervisor password, the other items appear to allow you to change other security settings.

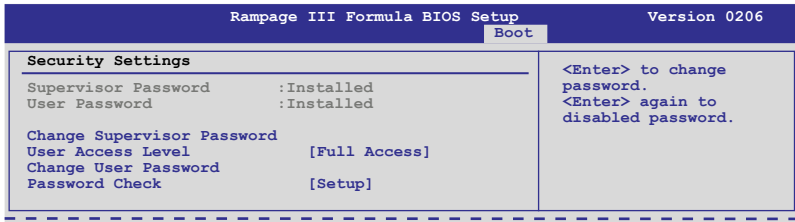

User Access Level [Full Access]

This item allows you to select the access restriction to the Setup items. Configuration options: [No Access] [View Only] [Limited] [Full Access]

- [No Access] prevents user access to the Setup utility.
- [View Only] allows access but does not allow change to any field.
- [Limited] allows changes only to selected fields, such as Date and Time.
- [Full Access] allows viewing and changing all the fields in the Setup utility.

Change User Password

Select this item to set or change the user password. The **User Password** item on top of the screen shows the default **Not Installed**. After you set a password, this item shows Installed.

To set a User Password:

1. Select the **Change User Password** item and press <Enter>.
2. On the password box that appears, type a password composed of at least six letters and/or numbers, then press <Enter>.
3. Confirm the password when prompted.

The message **Password Installed** appears after you set your password successfully.

To change the user password, follow the same steps as in setting a user password.

Password Check [Setup]

When set to [Setup], BIOS checks for user password when accessing the Setup utility. When set to [Always], BIOS checks for user password both when accessing Setup and booting the system. Configuration options: [Setup] [Always]

3.8 Tools menu

The Tools menu items allow you to configure options for special functions. Select an item then press <Enter> to display the sub-menu.

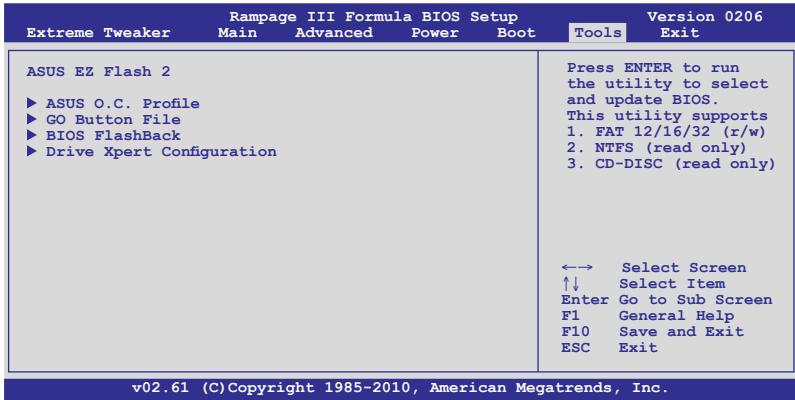

3.8.1 ASUS EZ Flash 2

Allows you to run ASUS EZ Flash 2. When you press <Enter>, a confirmation message appears. Use the left/right arrow key to select between [Yes] or [No], then press <Enter> to confirm your choice.



For more details, refer to **section 3.1.2 ASUS EZ Flash 2 utility**.

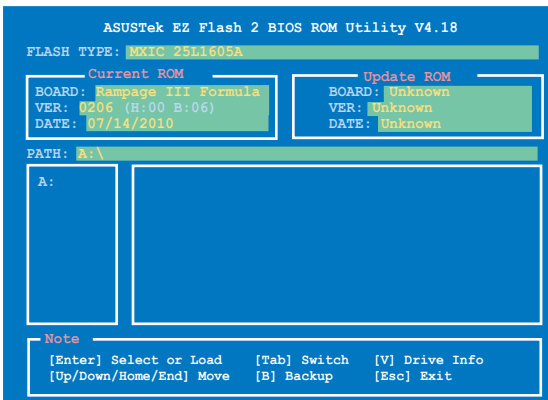

3.8.2 ASUS O.C. Profile

This item allows you to store or load multiple BIOS settings.

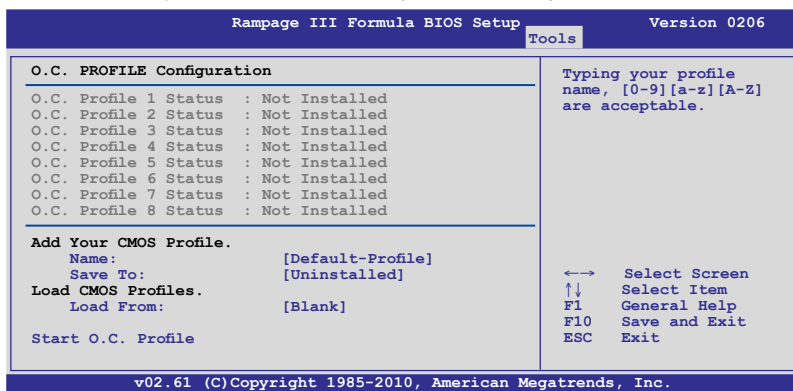

Add Your CMOS Profile

Allows you to save the current BIOS file to the BIOS Flash. In the Name sub-item, type your profile name and press <Enter>, and then choose a profile number to save your CMOS settings in the Save to sub-item.

Load CMOS Profiles

Allows you to load the previous BIOS settings saved in the BIOS Flash. Press <Enter>, and choose a profile to load.

Start O.C. Profile

Allows you to run the utility to save and load CMOS. Press <Enter> to run the utility.

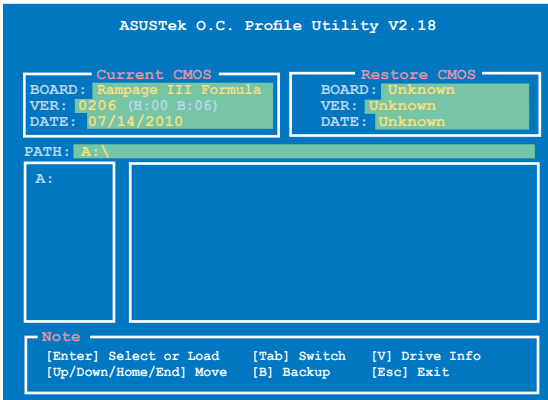

-
- This function supports devices such as a USB flash disk (FAT 32/16 format) or a floppy disk with single partition only.
 - DO NOT shut down or reset the system while updating the BIOS to prevent the system boot failure!
 - We recommend that you update the BIOS file only coming from the same memory/CPU configuration and BIOS version.
 - Only the CMO file can be loaded.
-

3.8.3 GO_Button File

This menu allows you to set the GO Button files, and load the desired GO Button file.

Rampage III Formula BIOS Setup Tools Version 0206

GO_Button File

Enable or Disable Frequency Controller

Current Settings
BCLK Speed :133MHz
PCIe Speed :100MHz
CPU Voltage :1.230V
CPU PLL Voltage :1.812V
QPI/DRAM Voltage :1.151V
IOH Voltage :1.111V
IOH PCIe Voltage :1.508V
ICH Voltage :1.111V
DRAM Voltage :1.601V

Frequency Controller [Disabled]
CPU Voltage [Auto]
CPU PLL Voltage [Auto]
QPI/DRAM Core Voltage [Auto]
IOH Voltage [Auto]
ICH Voltage [Auto]

←→ Select Screen
↑↓ Select Item
+- Change Option
F1 General Help
F10 Save and Exit
ESC Exit

v02.61 (C) Copyright 1985-2010, American Megatrends, Inc.

Scroll down to display the following items:

ICH PCIE Voltage [Auto]
DRAM Bus Voltage [Auto]

Save Above Settings
Load Default Settings

←→ Select Screen
↑↓ Select Item
+- Change Option
F1 General Help
F10 Save and Exit
ESC Exit

v02.61 (C) Copyright 1985-2010, American Megatrends, Inc.

Frequency Controller; CPU Voltage; CPU PLL Voltage; QPI/DRAM Core Voltage; IOH Voltage; IOH PCIE Voltage; ICH Voltage; ICH PCIE Voltage; DRAM Bus Voltage

Allows you to use the <+> and <-> keys to adjust the values for each item. Refer to **3.3 Extreme Tweaker** Menu for details.

Save Above Settings

Allows you to save the adjusted values for specific items as a GO_Button file.

Load Above Settings

Allows you to load the desired GO_Button file.

3.8.4 BIOS FlashBack

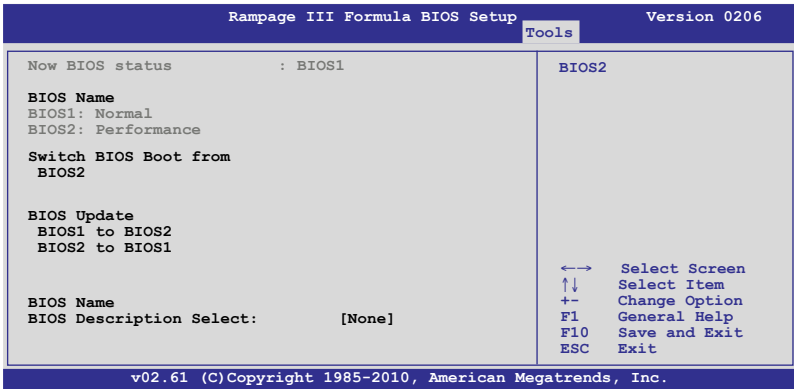

Switch BIOS Boot from

BIOS2

Press <Enter> to change the BIOS ROM for booting.

BIOS Update

BIOS1 to BIOS2

Press <Enter> to copy the current settings of BIOS1 to BIOS2.

BIOS Name

BIOS Description Select [None]

Add a description to each BIOS for convenient usage.

Configuration options: [None] [BIOS1] [BIOS2]

3.8.5 Drive Xpert Configuration

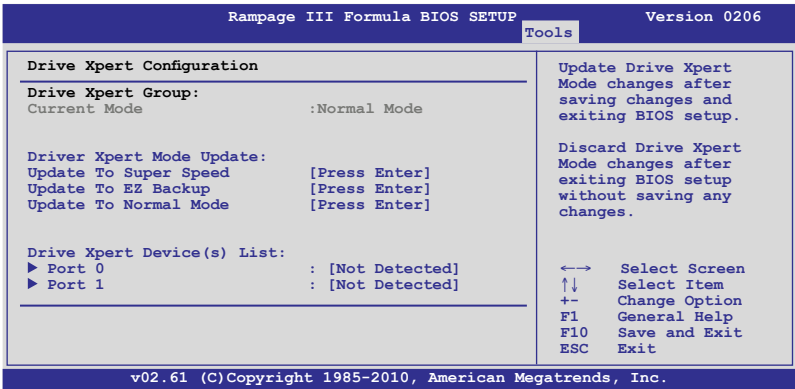

- Before using the Drive Xpert function, ensure that you have connected the SATA signal cables and installed SATA hard disk drives to the SATA_6G_1 and SATA_6G_2 connectors.
- You can only make one Drive Xpert change a time before you save BIOS settings and restart the computer.

Drive Xpert Group:

Current Mode

Displays the current Drive Xpert mode.

Changed Mode

This item appears only when you select a Drive Xpert mode to update and displays the Drive Xpert mode that you have changed.

Drive Xpert Mode Update:

Update To Super Speed [Press Enter]

Allows you to use the **Super Speed** function that combines two hard drives as one single drive partition.



All original data of the two hard drives will be erased for Super Speed setup.

Update To EZ Backup [Press Enter]

Allows you to use the **EZ Backup** function that copies and maintains an identical image of data from the SATA_6G_1 drive to the SATA_6G_2 drive.



All original data of the SATA_6G_2 hard disk will be erased for EZ Backup setup.

Update To Normal Mode [Press Enter]

Allows you to use the SATA_6G_1 and SATA_6G_2 connectors as normal SATA connectors.



When using only one hard disk in **Normal Mode**, connect the hard disk to the SATA_6G_1 connector on the motherboard.

Drive Xpert Device(s) List:

Port 0 / Port 1

Press <Enter> to display the information of the hard disks which are connected to the SATA_6G_1 and SATA_6G_2 connectors on the motherboard.

3.9 Exit menu

The Exit menu items allow you to load the optimal or failsafe default values for the BIOS items, and save or discard your changes to the BIOS items.

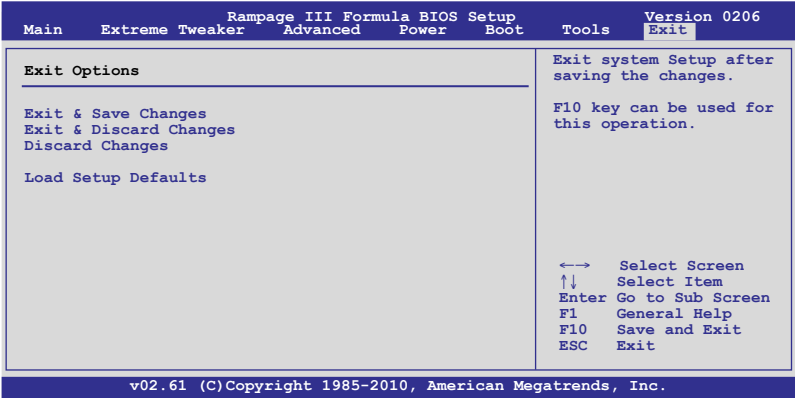

Pressing <Esc> does not immediately exit this menu. Select one of the options from this menu or <F10> from the legend bar to exit.

Exit & Save Changes

Once you are finished making your selections, choose this option from the Exit menu to ensure the values you selected are saved to the CMOS RAM. An onboard backup battery sustains the CMOS RAM so it stays on even when the PC is turned off. When you select this option, a confirmation window appears. Select YES to save changes and exit.



If you attempt to exit the Setup program without saving your changes, the program prompts you with a message asking if you want to save your changes before exiting. Press <Enter> to save the changes while exiting.

Exit & Discard Changes

Select this option only if you do not want to save the changes that you made to the Setup program. If you made changes to fields other than System Date, System Time, and Password, the BIOS asks for a confirmation before exiting.

Discard Changes

This option allows you to discard the selections you made and restore the previously saved values. After selecting this option, a confirmation appears. Select YES to discard any changes and load the previously saved values.

Load Setup Defaults

This option allows you to load the default values for each of the parameters on the Setup menus. When you select this option or if you press <F5>, a confirmation window appears. Select YES to load default values. Select Exit & Save Changes or make other changes before saving the values to the non-volatile RAM.

This chapter describes the contents of the support DVD that comes with the motherboard package and the software.

4 Software support

4.1	Installing an operating system	4-1
4.2	Support DVD information	4-1
4.3	Software information	4-8
4.4	RAID configurations	4-18
4.5	Creating a RAID driver disk.....	4-25

4.1 Installing an operating system

This motherboard supports Windows® XP/64-bit XP/Vista/7 operating systems (OS). Always install the latest OS version and corresponding updates to maximize the features of your hardware.



- Motherboard settings and hardware options vary. Use the setup procedures presented in this chapter for reference only. Refer to your OS documentation for detailed information.
- Ensure that you install Windows® XP Service Pack 2 or later versions before installing the drivers for better compatibility and system stability.

4.2 Support DVD information

The support DVD that came with the motherboard package contains the drivers, software applications, and utilities that you can install to avail all motherboard features.



The contents of the support DVD are subject to change at any time without notice. Visit the ASUS website at www.asus.com for updates.

4.2.1 Running the support DVD

Place the support DVD to the optical drive. The DVD automatically displays the Drivers menu if Autorun is enabled in your computer.

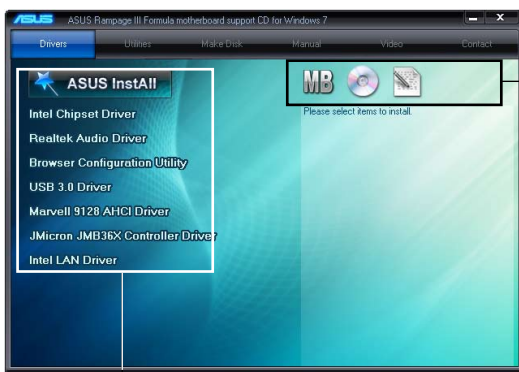

Click an icon to display support DVD/motherboard information

Click an item to install



If Autorun is NOT enabled in your computer, browse the contents of the support DVD to locate the file ASSETUP.EXE from the BIN folder. Double-click the ASSETUP.EXE to run the DVD.

4.2.2 Drivers menu

The drivers menu shows the available device drivers if the system detects installed devices. Install the necessary drivers to activate the devices.



ASUS InstAll - Drivers Installation Wizard

Launches the ASUS InstAll driver installation wizard.

Intel Chipset Driver

Installs the Intel® chipset driver.

Realtek Audio Driver

Installs the Realtek® audio driver and application.

Marvell 9128 AHCI Driver

Installs the Marvell® 9128 AHCI driver.

USB 3.0 Driver

Installs the USB 3.0 driver.

Intel LAN Driver

Installs the Intel® LAN driver.

4.2.3 Utilities menu

The Utilities menu shows the applications and other software that the motherboard supports.



ASUS InstAll - Installation Wizard for Utilities

Installs all of the utilities through the Installation Wizard.

ASUS AI Suite II

Installs the ASUS AI Suite II.

Sound Blaster X-Fi MB 2 (available only under Windows Vista/7)

Installs the Sound Blaster X-Fi MB 2 driver and utility.

Marvell MRU Utility

Installs the Marvell® MRU utility.

Adobe Reader 9

Installs the Adobe® Reader that allows you to open, view, and print documents in Portable Document Format (PDF).

Anti-Virus Utility

The anti-virus application scans, identifies, and removes computer viruses. View the online help for detailed information.

ASUUS ROG GameFirst

Installs the ASUS ROG GameFirst utility.

ASUS ROG Connect

Installs the ASUS ROG Connect utility.

4.2.4 Make disk menu

The Make disk menu contains items to create the Intel ICH10R driver disk.



Intel AHCI/RAID Driver

Allows you to create an Intel® AHCI/RAID driver disk.

Marvell 9128 AHCI SATA Driver

Allows you to create a Marvell® 9128 AHCI SATA driver disk.

4.2.5 Manual menu

The Manuals menu contains a list of supplementary user manuals. Click an item to open the folder of the user manual.



Most user manual files are in Portable Document Format (PDF). Install the Adobe® Acrobat® Reader from the Utilities menu before opening a user manual file.



4.2.6 Video menu

Click the Video tab to display a list of video clips. Click the video titles to watch ROG users' outstanding performances with ROG motherboards.



4.2.7 ASUS Contact information

Click the Contact tab to display the ASUS contact information. You can also find this information on the inside front cover of this user guide.

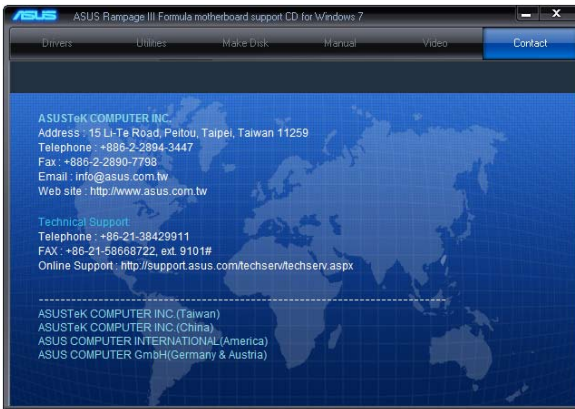

4.2.8 Other information

The icons on the top right corner of the screen give additional information on the motherboard and the contents of the support DVD. Click an icon to display the specified information.

Motherboard Info

Displays the general specifications of the motherboard.

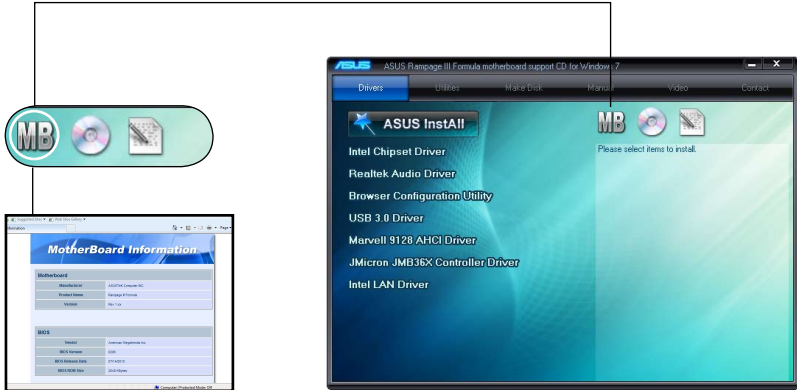

Browse this DVD

Displays the support DVD contents in graphical format.

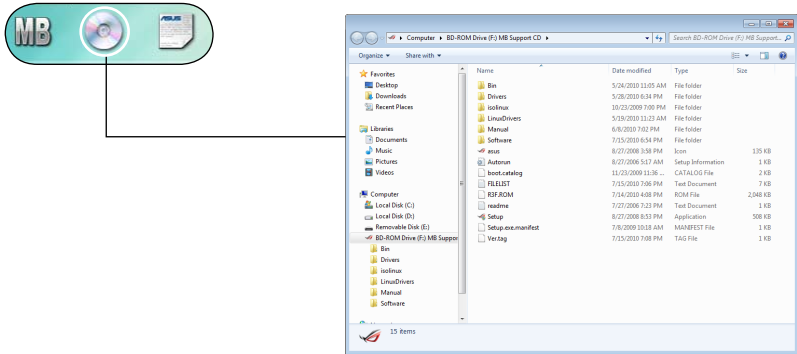

Filelist

Displays the contents of the support DVD and a brief description of each in text format.



```
FILELIST - Notepad
File Edit Format View Help
File list for the included support software for motherboard
-----
File Name      Description
-----
--Drivers
-Chipset       -Intel(R) chipset Software Installation utility v9.1.1.1025 for 32/64
-Audio         -Realtek Audio driver v5.10.0.6154 for 32/64bit windows XP (W80L)
               -Realtek Audio Driver V6.0.1.6154 For 32/64bit windows Vista & Wind
-LAN           -Intel(R) Gigabit Ethernet Driver V10.1.9.0 for 32/64bit windows XP
-RAID          -Intel(R) Matrix Storage Manager Driver V8.9.7.1001 For 32/64bit win
               -Marvell 9128 Controller Driver V1.0.0.1034 For windows 32/64bit XP
               -Marvell 9128 Controller Driver V1.0.0.1034 for windows 32/64bit XP
-MSM           -Intel(R) Matrix Storage Manager Driver V8.9.7.1001 For 32/64bit win
-Install       -Intel(R) ANCI/RAID driver Disk For 32/64bit windows XP & 32/64bit V
               -Intel(R) ANCI/RAID driver Disk For 32/64bit windows XP & 32/64bit V
-MB36X         -Micron MB36X(MB363) controller driver V1.17.52.2 For 32/64bit wi
-USB3          -NEC Electronics Corporation USB3.0 Controller driver V1.0.19.0 for
-BCU           -Browser Configuration utility V1.0.10.0 for windows 32/64bit XP & 3
```

4.3 Software information

Most of the applications in the support DVD have wizards that will conveniently guide you through the installation. View the online help or readme file that came with the software application for more information.

4.3.1 ASUS AI Suite II

ASUS AI Suite II allows you to launch several ASUS utilities easily.

Installing AI Suite II

To install AI Suite II on your computer:

1. Place the support DVD to the optical drive. The Drivers installation tab appears if your computer has an enabled Autorun feature.
2. Click the Utilities tab, then click **AI Suite II**.
3. Follow the screen instructions to complete installation.

Launching AI Suite II

You can launch AI Suite II right after installation or anytime from the Windows® desktop.

To launch AI Suite from the Windows® desktop, click **Start > All Programs > ASUS > AI Suite II > AI Suite II v1.xx.xx**. The AI Suite II main window appears.

After launching the application, the AI Suite II icon appears in the Windows® notification area. Click the icon to close or restore the application.

Using AI Suite II

Click each button to select and launch a desired utility, to monitor or update the system, to display the system information and to customize your settings.

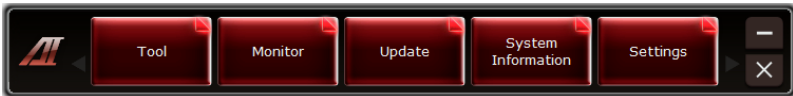

4.3.2 TurboV EVO

ASUS TurboV EVO introduces **TurboV** that allows you to overclock your system effectively. After installing AI Suite II from the motherboard support DVD, launch TurboV EVO by clicking **Tool > TurboV EVO** on the AI Suite II main window.



Using Manual Mode

Manual Mode allow you to overclock the BCLK frequency, CPU voltage, IMC voltage, and DRAM Bus voltage in Windows® environment and takes effect in real-time without exiting and rebooting the OS.



Refer to the CPU documentation before adjusting CPU voltage settings. Setting a high voltage may damage the CPU permanently, and setting a low voltage may make the system unstable.



For system stability, all changes made in Manual Mode will not be saved to BIOS settings and will not be kept on the next system boot. Use the **Save Profile** function to save your customized overclocking settings and manually load the profile after Windows starts.



For advanced overclock ability, adjust first the BIOS items, and then proceed more detailed adjustments using **Manual Mode**.

Using CPU Level Up

The CPU Level Up allows you to overclock immediately with OC profile presets in Windows® environment without the hassle of entering BIOS.

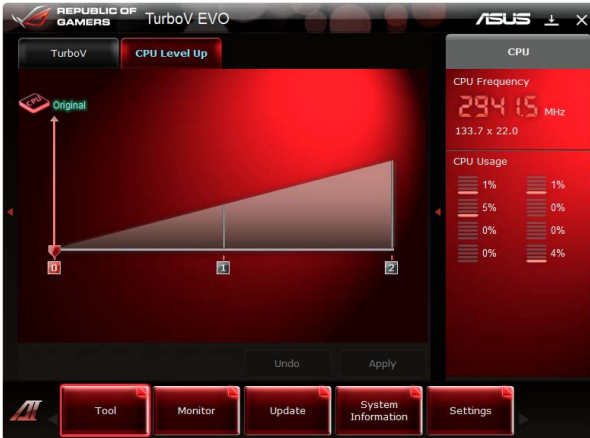

Move the pointer to level up your CPU and click **Apply** to use the new CPU frequency configuration.



4.3.3 FAN Xpert

FAN Xpert allows you to adjust both the CPU and chassis fan speeds according to different ambient temperatures and your PC's system loading. The various fan profiles offer flexible controls of fan speeds to achieve a quiet and cool system environment.

Launching FAN Xpert

After installing AI Suite II from the motherboard support DVD, launch FAN Xpert by clicking **Tool > Fan Xpert** on the AI Suite II main window.

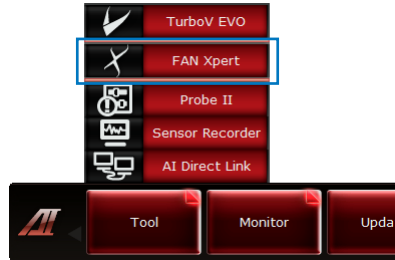

Using FAN Xpert

Click **Fan Name** to select a fan to test the speed or click **Setting** to select a preset mode for your selected fan.

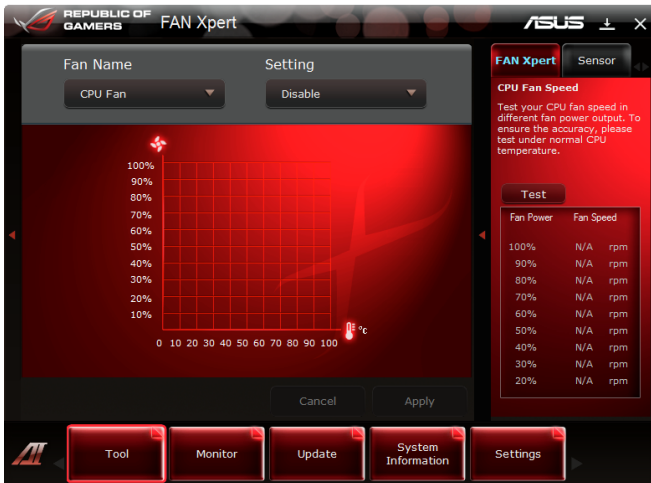

Setting

- **Disable:** disables the **Fan Xpert** function.
- **Standard:** adjusts fan speed in a moderate pattern.
- **Silent:** minimizes fan speed for quiet fan operation.
- **Turbo:** maximizes the fan speed for the best cooling effect.
- **Intelligent:** automatically adjusts the CPU fan speed according to the ambient temperature.
- **Stable:** fixes the CPU fan speed to avoid noise caused by the unsteady fan rotation. The fan will speed up when the temperature exceeds 70°C.
- **User:** Allows you to configure the CPU fan profile under certain limitations.

4.3.4 Probe II

Probe II is a utility that monitors the computer's vital components, and detects and alerts you of any problem with these components. Probe II senses fan rotations, CPU temperature, and system voltages, among others. Because Probe II is software-based, you can start monitoring your computer the moment you turn it on. With this utility, you are assured that your computer is always at a healthy operating condition.

Launching Probe II

After installing AI Suite II from the motherboard support DVD, launch PC Probe II by clicking **Tool > Probe II** on the AI Suite II main window.

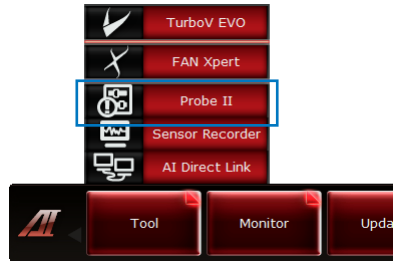

Monitoring hardware

The hardware monitor panels display the current value of a system sensor such as fan rotation, CPU temperature, and voltages. Click the tab on the top to switch display content. Click the box before each sensor to enable the alert function.

Adjusting the sensor threshold value

You can adjust the sensor threshold value in the monitor panel by moving the sliders.



Setting preference

Click **Preference** on the top to customize **Probe II**, including detection cycle, and temperature display unit.



Checking Alert Log

Click **Alert Log** on the top to check the log. Click **Clear** to reset the log if needed.



4.3.5 Sensor Recorder

Sensor Recorder allows you to monitor the change in your system including voltage, temperature and fan speed. You can also browse the history record.

Launching Sensor Recorder

After installing AI Suite II from the motherboard support DVD, launch PC Probe II by clicking **Tool > Sensor Recorder** on the AI Suite II main window.

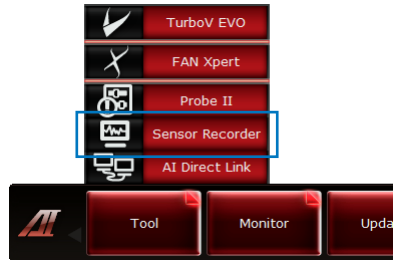

Using Sensor Recorder

Select and click the tabs on the top to switch to the monitor panel.

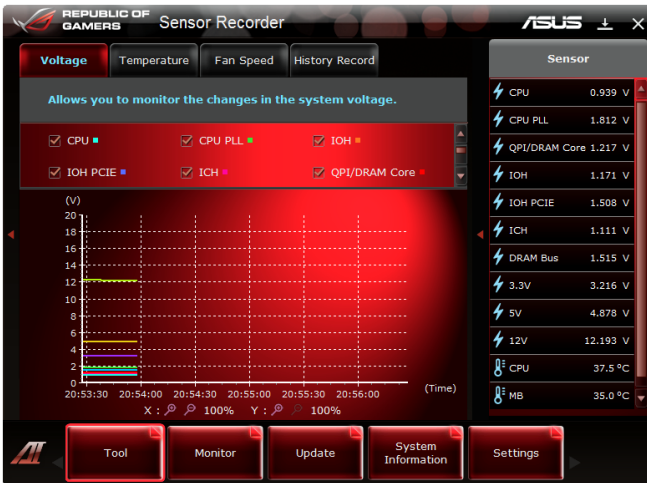

4.3.6 Sound Blaster X-Fi MB 2



This application is available only under Windows Vista and Windows 7 operating system.



This installation requires that you have the latest version of the Windows Media Player installed on your system. Ensure to download and install the latest Windows Media Player before installing Sound Blaster X-Fi MB 2.

The onboard 8-channel HD audio (High Definition Audio, previously code-named Azalia) CODEC enables high-quality 192KHz/24-bit audio output, jack-sensing feature, retasking functions and multi-streaming technology that simultaneously sends different audio streams to different destinations.

Activating Sound Blaster X-Fi MB 2

After installing Sound Blaster X-Fi MB 2 successfully, you need to activate this utility online before first use.

1. Double-click **Activate** on the desktop.



Ensure that you have successfully installed the LAN driver and have connected to the Internet.

2. Click **Activate** to start activation.



Using Sound Blaster X-Fi MB 2

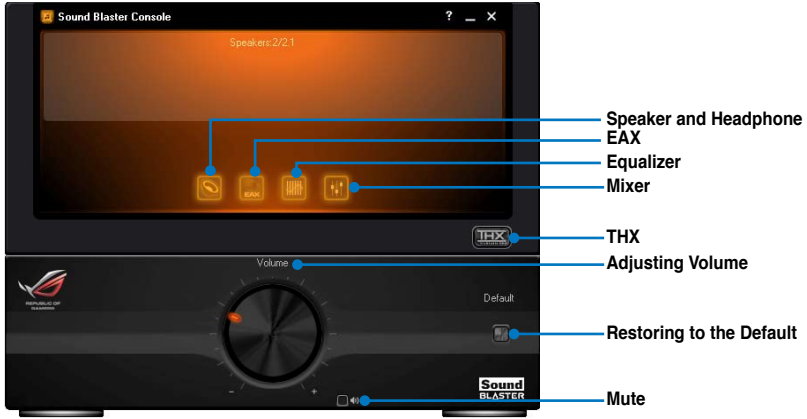

Speaker and Headphone
You can adjust the speaker-related or the headphone-related configurations.

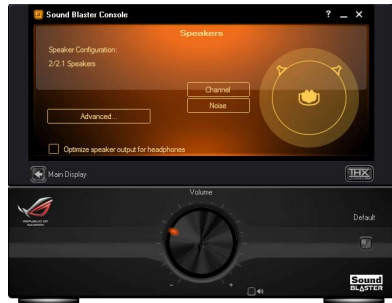

Environment audio extensions (EAX)
After enabling the EAX effects, you are allowed to select and add your desired environment sounds into the music.

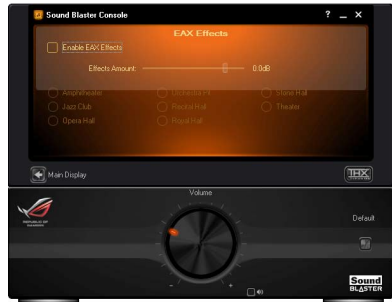

Equalizer

You can manually adjust the audio frequency with the equalizer and customize your presets for later use.



Mixer

You can manually adjust the audio volumes, including Line In, Stereo Mix and Microphone, when recording or during the playback.



THX

THX is a high-fidelity sound technology that allows you to adjust the surround sound effect, sub-woofer volume, etc..



4.4 RAID configurations

The motherboard comes with the Intel® ICH10R Southbridge controller that supports RAID 0, RAID 1, RAID 10, and RAID 5 for six independent Serial ATA channels.

4.4.1 RAID definitions

RAID 0 (Data striping) optimizes two identical hard disk drives to read and write data in parallel, interleaved stacks. Two hard disks perform the same work as a single drive but at a sustained data transfer rate, double that of a single disk alone, thus improving data access and storage. Use of two new identical hard disk drives is required for this setup.

RAID 1 (Data mirroring) copies and maintains an identical image of data from one drive to a second drive. If one drive fails, the disk array management software directs all applications to the surviving drive as it contains a complete copy of the data in the other drive. This RAID configuration provides data protection and increases fault tolerance to the entire system. Use two new drives or use an existing drive and a new drive for this setup. The new drive must be of the same size or larger than the existing drive.

RAID 5 stripes both data and parity information across three or more hard disk drives. Among the advantages of RAID 5 configuration include better HDD performance, fault tolerance, and higher storage capacity. The RAID 5 configuration is best suited for transaction processing, relational database applications, enterprise resource planning, and other business systems. Use a minimum of three identical hard disk drives for this setup.

RAID 10 is data striping and data mirroring combined without parity (redundancy data) having to be calculated and written. With the RAID 10* configuration you get all the benefits of both RAID 0 and RAID 1 configurations. Use four new hard disk drives or use an existing drive and three new drives for this setup.

Intel® Matrix Storage. The Intel® Matrix Storage technology supported by the ICH10R chip allows you to create a RAID 0, RAID 1, RAID 5, and RAID 10 function to improve both system performance and data safety. You can also combine two RAID sets to get higher performance, capacity, or fault tolerance provided by the difference RAID function. For example, RAID 0 and RAID 1 set can be created by using only two identical hard disk drives.



If you want to boot the system from a hard disk drive included in a created RAID set, copy first the RAID driver from the support DVD to a floppy disk before you install an operating system to the selected hard disk drive. Refer to section **4.5 Creating a RAID driver disk** for details.

4.4.2 Installing Serial ATA hard disks

The motherboard supports Serial ATA hard disk drives. For optimal performance, install identical drives of the same model and capacity when creating a disk array.

To install the SATA hard disks for a RAID configuration:

1. Install the SATA hard disks into the drive bays.
2. Connect the SATA signal cables.
3. Connect a SATA power cable to the power connector on each drive.

4.4.3 Setting the RAID item in BIOS

You must enable the RAID function in the BIOS Setup before creating RAID set(s) using SATA HDDs. To do this:

1. Enter the BIOS Setup during POST.
2. Go to the **Main** menu > **Storage Configuration**, and then press <Enter>.
3. Set the **Configure SATA as** item to [RAID].
4. Save your changes, and then exit the BIOS Setup.



Refer to Chapter 3 for details on entering and navigating through the BIOS Setup.

4.4.4 Intel® Matrix Storage Manager option ROM utility

The Intel® Matrix Storage Manager Option ROM utility allows you to create RAID 0, RAID 1, RAID 10 (RAID 0+1), and RAID 5 set(s) from Serial ATA hard disk drives that are connected to the Serial ATA connectors supported by the Southbridge.

To enter the Intel® Matrix Storage Manager option ROM utility:

1. Turn on the system.
2. During POST, press <Ctrl+I> to display the utility main menu.

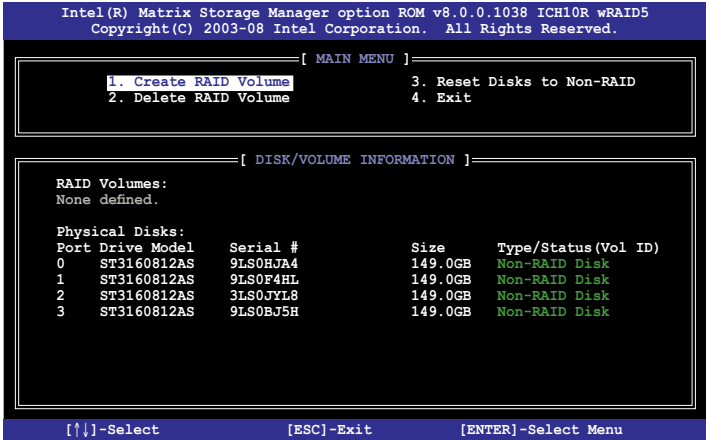

The navigation keys at the bottom of the screen allow you to move through the menu and select the menu options.



The RAID BIOS setup screens shown in this section are for reference only and may not exactly match the items on your screen.



The utility supports maximum four hard disk drives for RAID configuration.

Creating a RAID set

To create a RAID set

1. From the utility main menu, select **1. Create RAID Volume** and press <Enter>. The following screen appears.

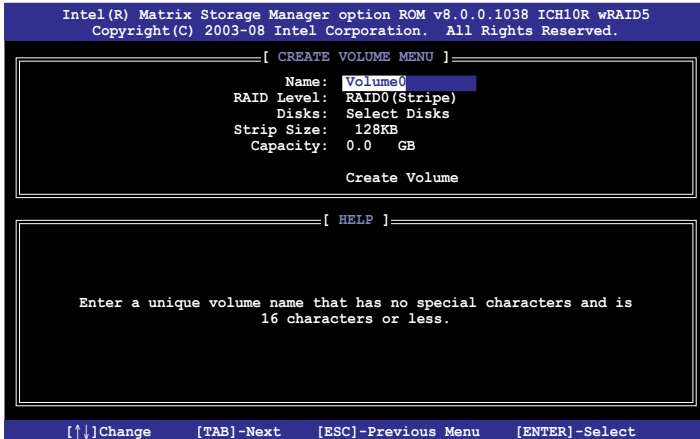

2. Enter a name for the RAID set and press <Enter>.
3. When the **RAID Level** item is selected, press the up/down arrow key to select a RAID level to create, and then press <Enter>.
4. When the **Disks** item is selected, press <Enter> to select the hard disk drives you want to include in the RAID set. The **SELECT DISKS** screen appears.

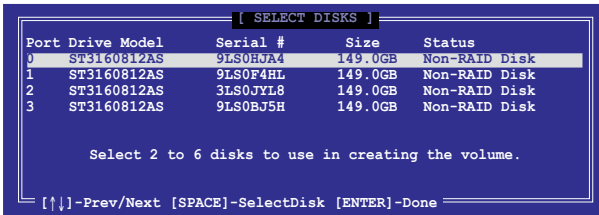

5. Use the up/down arrow key to select a drive, and then press <Space> to select. A small triangle marks the selected drive. Press <Enter> after completing your selection

6. Use the up/down arrow key to select the stripe size for the RAID array (for RAID 0, 10 and 5 only), and then press <Enter>. The available stripe size values range from 4 KB to 128 KB. The following are typical values:
RAID 0: 128KB
RAID 10: 64KB
RAID 5: 64KB



We recommend a lower stripe size for server systems, and a higher stripe size for multimedia computer systems used mainly for audio and video editing.

7. When the **Capacity** item is selected, enter the RAID volume capacity that you want and press <Enter>. The default value indicates the maximum allowed capacity.
8. When the **Create Volume** item is selected, press <Enter>. The following warning message appears.

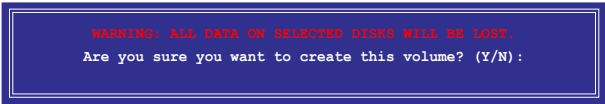

9. Press <Y> to create the RAID volume and return to the main menu, or <N> to go back to the **CREATE VOLUME** menu.

Deleting a RAID set



Take caution when deleting a RAID set. You will lose all data on the hard disk drives when you delete a RAID set.

To delete a RAID set

1. From the utility main menu, select **2. Delete RAID Volume** and press <Enter>. The following screen appears.

```
Intel(R) Matrix Storage Manager option ROM v8.0.0.1038 ICH10R wRAID5
Copyright(C) 2003-08 Intel Corporation. All Rights Reserved.

[ DELETE VOLUME MENU ]

Name      Level      Drives  Capacity  Status  Bootable
Volume0   RAID0 (Stripe)  2       298.0GB  Normal  Yes

[ HELP ]

Deleting a volume will reset the disks to non-RAID.
WARNING: ALL DISK DATA WILL BE DELETED.

[↑↓]-Select      [ESC]-Previous Menu  [DEL]-Delete Volume
```

2. Use the up/down arrow key to select the RAID set you want to delete, and then press . The following warning message appears.

```
[ DELETE VOLUME VERIFICATION ]

ALL DATA IN THE VOLUME WILL BE LOST!

Are you sure you want to delete volume "Volume0"? (Y/N):
```

3. Press <Y> to delete the RAID set and return to the utility main menu, or press <N> to return to the **DELETE VOLUME** menu.

Exiting the Intel® Matrix Storage Manager

To exit the utility

1. From the utility main menu, select **4. Exit**, and then press <Enter>. The following warning message appears.

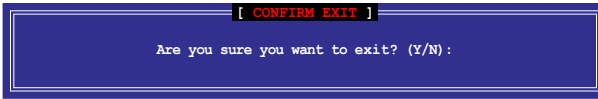

2. Press <Y> to exit or press <N> to return to the utility main menu.

4.5 Creating a RAID driver disk

A floppy disk with the RAID driver is required when installing Windows® XP/Vista and later operating system on a hard disk drive that is included in a RAID set. For Windows Vista user, you can create a RAID driver disk with a floppy disk drive or a USB flash disk drive.

4.5.1 Creating a RAID driver disk without entering the OS

To create a RAID/SATA driver disk without entering the OS:

1. Boot your computer.
2. Press during POST to enter the BIOS setup utility.
3. Set the optical drive as the primary boot device.
4. Insert the support DVD into the optical drive.
5. Save changes and exit BIOS.
6. When the **Make Disk** menu appears, press <a> or to create a 32/64bit **Intel ICH10R RAID driver disk**.
7. Insert a formatted floppy disk into the floppy drive then press <Enter>.
8. Follow the succeeding screen instructions to complete the process.

4.5.2 Creating a RAID driver disk in Windows®

To create a RAID driver disk in Windows®:

1. Start Windows®.
2. Place the motherboard support DVD into the optical drive.
3. Go to the **Make disk** menu, and then click **Intel ICH10R 32/64 bit RAID Driver Disk** to create an Intel® ICH10R RAID driver disk.
4. Insert a floppy disk into the floppy disk drive.
5. Follow the succeeding screen instructions to complete the process.



Write-protect the floppy disk to avoid computer virus infection.

To install the RAID driver in Windows® XP:

1. During the OS installation, the system prompts you to press the F6 key to install third-party SCSI or RAID driver.
2. Press <F6>, and then insert the floppy disk with RAID driver into the floppy disk drive.
3. When prompted to select the SCSI adapter to install, ensure that you select **Intel(R) SATA RAID Controller (Desktop ICH10R)**.
4. Follow the succeeding screen instructions to complete the installation.

To install the RAID driver in Windows® Vista™:

1. Insert the floppy disk/USB device with RAID driver into the floppy disk drive/USB port.
2. During the OS installation, select **Intel(R) SATA RAID Controller (Desktop ICH10R)**.
3. Follow the succeeding screen instructions to complete the installation.

This chapter describes how to install and
configure ATI® CrossFireX™ graphics
cards.

ATI® CrossFireX™ technology support

A large, light gray, stylized number '5' is positioned behind the text 'ATI® CrossFireX™' and 'technology support'. The number is semi-transparent and serves as a background element for the chapter title.

5.1 ATI® CrossFireX™ technology 5-1

5.2 NVIDIA® SLI™ technology 5-5

5.1 ATI® CrossFireX™ technology

The motherboard supports the ATI® CrossFireX™ technology that allows you to install multi-graphics processing units (GPU) graphics cards. Follow the installation procedures in this section.

5.1.1 Requirements

- You should have two identical CrossFireX-ready graphics cards or one CrossFireX-ready dual-GPU graphics card that are ATI® certified.
- Ensure that your graphics card driver supports the ATI CrossFireX technology. Download the latest driver from the AMD website at www.amd.com.
- Ensure that your power supply unit (PSU) can provide at least the minimum power required by your system. See page 2-45 for details.



-
- We recommend that you install additional chassis fans for better thermal environment.
 - Visit the ATI Game website at <http://game.amd.com> for the latest certified graphics card and the supported 3D application list.
-

5.1.2 Before you begin

For ATI CrossFireX to work properly, you have to uninstall all existing graphics card drivers before installing ATI CrossFireX graphics cards to your system.

To uninstall existing graphics card drivers

1. Close all current applications.
2. For Windows XP, go to **Control Panel > Add/Remove Programs**.
For Windows Vista, go to **Control Panel > Programs and Features**.
3. Select your current graphics card driver/s.
4. For Windows XP, select **Add/Remove**.
For Windows Vista, select **Uninstall**.
5. Turn off your computer.

5.1.3 Installing CrossFireX graphics cards



The following pictures are for reference only. The graphics cards and the motherboard layout may vary with models, but the installation steps remain the same.

1. Prepare two CrossFireX-ready graphics cards.
2. Insert the two graphics card into the PCIEX16 slots.
3. Ensure that the cards are properly seated on the slots.

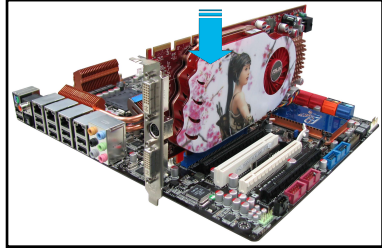

4. Align and firmly insert the CrossFireX bridge connector to the goldfingers on each graphics card. Ensure that the connector is firmly in place.

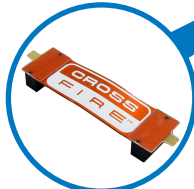
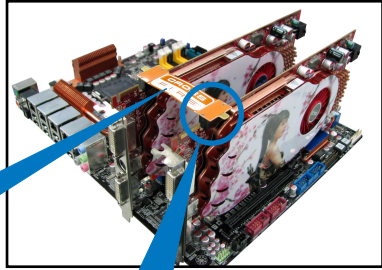

CrossFireX bridge

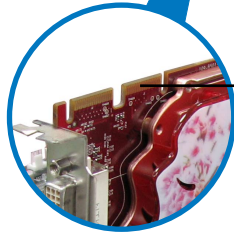

Goldfingers

5. Connect two independent auxiliary power sources from the power supply to the two graphics cards separately.
6. Connect a VGA or a DVI cable to the graphics card.

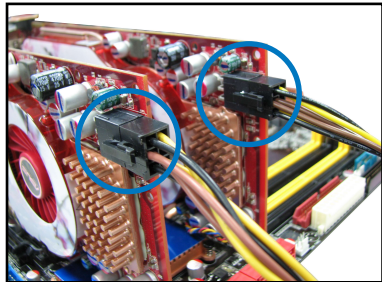

5.1.4 Installing the device drivers

Refer to the documentation that came with your graphics card package to install the device drivers.



Ensure that your PCI Express graphics card driver supports the ATI® CrossFireX™ technology. Download the latest driver from the AMD website (www.amd.com).

5.1.5 Enabling the ATI® CrossFireX™ technology

After installing your graphics cards and the device drivers, enable the CrossFireX™ feature through the ATI Catalyst™ Control Center in Windows environment.

Launching the ATI Catalyst Control Center

To launch the ATI Catalyst Control Center

1. Right-click on the Windows® desktop and select **Catalyst(TM) Control Center**. You can also right-click the ATI icon in the Windows notification area and select **Catalyst Control Center**.

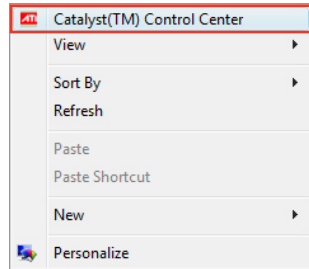

2. The **Catalyst Control Center Setup Assistant** appears when the system detects the existence of multi-graphics cards. Click **Go** to continue to the **Catalyst Control Center Advanced View** window.

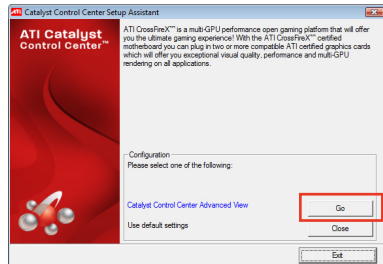

Enabling CrossFireX settings

1. In the Catalyst Control Center window, click **Graphics Settings > CrossFireX > Configure**.
2. From the Graphics Adapter list, select the graphics card to act as the display GPU.
3. Select **Enable CrossFireX**.
4. Click **Apply**, and then click **OK** to exit the window.

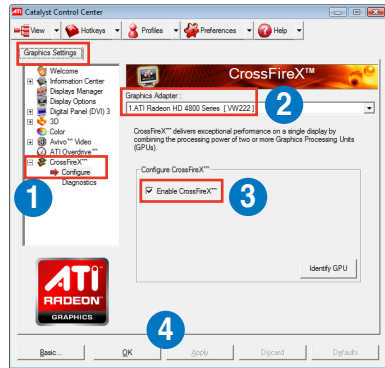

5.2 NVIDIA® SLI™ technology

The motherboard supports the NVIDIA® SLI™ (Scalable Link Interface) technology that allows you to install multi-graphics processing units (GPU) graphics cards. Follow the installation procedures in this section.

5.2.1 Requirements

- In SLI mode, you should have two identical SLI-ready graphics cards that are NVIDIA® certified.
- Ensure that your graphics card driver supports the NVIDIA SLI technology. Download the latest driver from the NVIDIA website (www.nvidia.com).
- Ensure that your power supply unit (PSU) can provide at least the minimum power required by your system. See Chapter 2 for details.



-
- We recommend that you install additional chassis fans for better thermal environment.
 - Visit the NVIDIA zone website (<http://www.nzone.com>) for the latest certified graphics card and supported 3D application list.
-

5.2.2 Installing two SLI-ready graphics cards



The following pictures are for reference only. The graphics cards and the motherboard layout may vary with models, but the installation steps remain the same.

1. Prepare two SLI-ready graphics cards.
2. Insert the two graphics card into the PCIEX16 slots. If your motherboard has more than two PCIEX16 slots, refer to Chapter 2 in this user manual for the locations of the PCIEX16 slots recommended for multi-graphics card installation.
3. Ensure that the cards are properly seated on the slots.

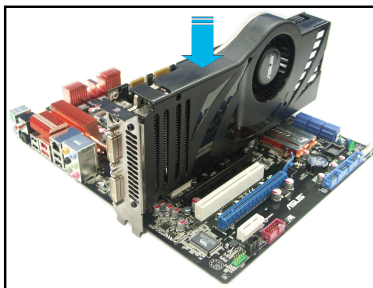

4. Align and firmly insert the SLI bridge connector to the goldfingers on each graphics card. Ensure that the connector is firmly in place.
5. Connect two independent auxiliary power sources from the power supply to the two graphics cards separately.
6. Connect a VGA or a DVI cable to the graphics card.

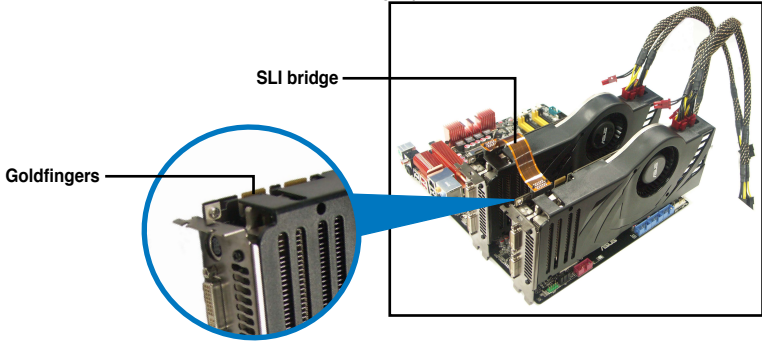

5.2.3 Installing the device drivers

Refer to the documentation that came with your graphics card package to install the device drivers.



Ensure that your PCI Express graphics card driver supports the NVIDIA® SLI™ technology. Download the latest driver from the NVIDIA website (www.nvidia.com).

5.2.4 Enabling the NVIDIA® SLI™ technology

After installing your graphics cards and the device drivers, enable the SLI feature in NVIDIA® Control Panel under the Windows® Vista™ operating system.

Launching the NVIDIA Control Panel

You can launch the NVIDIA Control Panel by the following two methods.

- A. Right click on the empty space of the Windows® desktop and select **NVIDIA Control Panel**.
The NVIDIA Control Panel window appears (See Step B5).

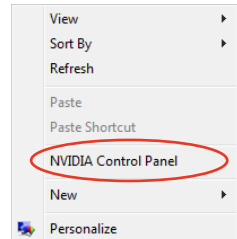

- B1. If you cannot see the NVIDIA Control Panel item in step (A), select **Personalize**.

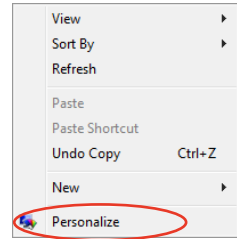

- B2. From the **Personalization** window, select **Display Settings**.

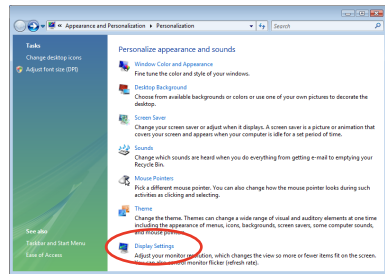

- B3. From the Display Settings dialog box, click **Advanced Settings**.

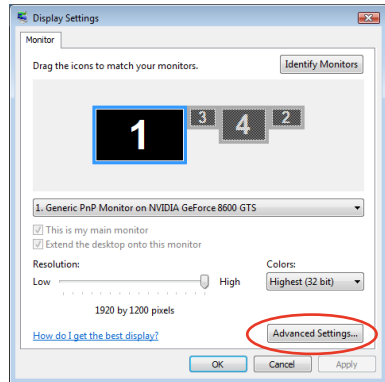

B4. Select the NVIDIA GeForce tab, and then click **Start the NVIDIA Control Panel**.

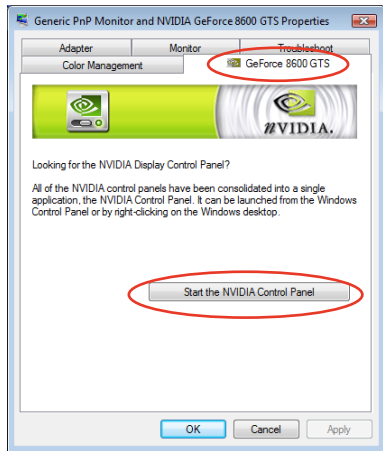

B5. The NVIDIA Control Panel window appears.

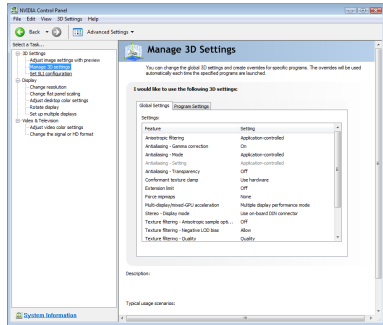

Enabling SLI settings

From the NVIDIA Control Panel window, select **Set SLI Configuration**. Click **Enable SLI** and set the display for viewing SLI rendered content. When done, click **Apply**.

