

SUPER  [®]

X10SAE

USER'S MANUAL

Revision 1.1c

The information in this User's Manual has been carefully reviewed and is believed to be accurate. The vendor assumes no responsibility for any inaccuracies that may be contained in this document, and makes no commitment to update or to keep current the information in this manual, or to notify any person or organization of the updates. **Please Note: For the most up-to-date version of this manual, please see our website at www.supermicro.com.**

Super Micro Computer, Inc. ("Supermicro") reserves the right to make changes to the product described in this manual at any time and without notice. This product, including software and documentation, is the property of Supermicro and/or its licensors, and is supplied only under a license. Any use or reproduction of this product is not allowed, except as expressly permitted by the terms of said license.

IN NO EVENT WILL SUPER MICRO COMPUTER, INC. BE LIABLE FOR DIRECT, INDIRECT, SPECIAL, INCIDENTAL, SPECULATIVE OR CONSEQUENTIAL DAMAGES ARISING FROM THE USE OR INABILITY TO USE THIS PRODUCT OR DOCUMENTATION, EVEN IF ADVISED OF THE POSSIBILITY OF SUCH DAMAGES. IN PARTICULAR, SUPER MICRO COMPUTER, INC. SHALL NOT HAVE LIABILITY FOR ANY HARDWARE, SOFTWARE, OR DATA STORED OR USED WITH THE PRODUCT, INCLUDING THE COSTS OF REPAIRING, REPLACING, INTEGRATING, INSTALLING OR RECOVERING SUCH HARDWARE, SOFTWARE, OR DATA.

Any disputes arising between the manufacturer and the customer shall be governed by the laws of Santa Clara County in the State of California, USA. The State of California, County of Santa Clara shall be the exclusive venue for the resolution of any such disputes. Supermicro's total liability for all claims will not exceed the price paid for the hardware product.

FCC Statement: This equipment has been tested and found to comply with the limits for a Class A digital device pursuant to Part 15 of the FCC Rules. These limits are designed to provide reasonable protection against harmful interference when the equipment is operated in a commercial environment. This equipment generates, uses, and can radiate radio frequency energy and, if not installed and used in accordance with the manufacturer's instruction manual, may cause harmful interference with radio communications. Operation of this equipment in a residential area is likely to cause harmful interference, in which case you will be required to correct the interference at your own expense.

California Best Management Practices Regulations for Perchlorate Materials: This Perchlorate warning applies only to products containing CR (Manganese Dioxide) Lithium coin cells. "Perchlorate Material-special handling may apply. See www.dtsc.ca.gov/hazardouswaste/perchlorate".

WARNING: Handling of lead solder materials used in this product may expose you to lead, a chemical known to the State of California to cause birth defects and other reproductive harm.

Manual Revision 1.1c

Release Date: January 8, 2015

Unless you request and receive written permission from Super Micro Computer, Inc., you may not copy any part of this document.

Information in this document is subject to change without notice. Other products and companies referred to herein are trademarks or registered trademarks of their respective companies or mark holders.

Copyright © 2015 by Super Micro Computer, Inc.
All rights reserved.

Printed in the United States of America

Preface

This manual is written for system integrators, IT technicians and knowledgeable end-users. It provides information for the installation and use of the **SUPER**® X10SAE motherboard.

About This Motherboard

The **SUPER**® X10SAE supports a single Intel® Xeon E3-1200V3 series processor or a 4th Generation Intel® Core™ i7/i5/i3 DT processor in an LGA 1150 (H3) socket. With the Intel® C226 Express chipset built in, the X10SAE motherboard supports Intel® Active Management Technology (iAMT), offering great system enhancement to the vPro/AMT workstation platform. Please refer to our website (<http://www.supermicro.com/products/>) for processor and memory support updates. This product is intended to be installed and serviced by professional technicians.

Manual Organization

Chapter 1 describes the features, specifications and performance of the motherboard, and provides detailed information on the Intel C226 Express chipset.

Chapter 2 provides hardware installation instructions. Read this chapter when installing the processor, memory modules and other hardware components into the system. If you encounter any problems, see **Chapter 3**, which describes troubleshooting procedures for video, memory and system setup stored in the CMOS.

Chapter 4 includes an introduction to the BIOS, and provides detailed information on running the CMOS Setup utility.

Appendix A provides BIOS Error Beep Codes.

Appendix B lists software program installation instructions.

Appendix C contains UEFI BIOS Recovery instructions.

Appendix D lists Crisis BIOS Recovery instructions using the Dual Boot Block scheme.

Conventions Used in the Manual:

Special attention should be given to the following symbols for proper installation and to prevent damage done to the components or injury to yourself:

Warning: Critical information to prevent damage to the components or injury to yourself.



Important: Important information given to ensure proper system installation or to relay safety precautions.



Note: Additional Information given to differentiate various models or to provide instructions for correct system setup.

Contacting Supermicro

Headquarters

Address: Super Micro Computer, Inc.
980 Rock Ave.
San Jose, CA 95131 U.S.A.

Tel: +1 (408) 503-8000

Fax: +1 (408) 503-8008

Email: marketing@supermicro.com (General Information)
support@supermicro.com (Technical Support)

Web Site: www.supermicro.com

Europe

Address: Super Micro Computer B.V.
Het Sterrenbeeld 28, 5215 ML
's-Hertogenbosch, The Netherlands

Tel: +31 (0) 73-6400390

Fax: +31 (0) 73-6416525

Email: sales@supermicro.nl (General Information)
support@supermicro.nl (Technical Support)
rma@supermicro.nl (Customer Support)

Web Site: www.supermicro.nl

Asia-Pacific

Address: Super Micro Computer, Inc.
3F, No. 150, Jian 1st Rd.
Zhonghe Dist., New Taipei City 235
Taiwan (R.O.C)

Tel: +886-(2) 8226-3990

Fax: +886-(2) 8226-3992

Email: support@supermicro.com.tw

Web Site: www.supermicro.com.tw

Table of Contents

Preface

Chapter 1 Introduction

1-1	Overview	1-1
1-2	Chipset Overview	1-9
1-3	Special Features	1-10
1-4	PC Health Monitoring	1-10
1-5	ACPI Features	1-11
1-6	Power Supply	1-11
1-7	Super I/O	1-12

Chapter 2 Installation

2-1	Standardized Warning Statements	2-1
2-2	Static-Sensitive Devices	2-4
2-3	Processor and Heatsink Installation	2-5
	Installing the LGA1150 Processor	2-5
	Installing a Passive CPU Heatsink	2-8
	Removing the Heatsink	2-9
2-4	Installing DDR3 Memory	2-10
	DIMM Installation	2-10
	Removing Memory Modules	2-11
	Memory Support	2-11
	Memory Population Guidelines	2-11
2-5	Motherboard Installation	2-13
	Tools Needed	2-13
	Location of Mounting Holes	2-13
	Installing the Motherboard	2-14
2-6	Connectors/IO Ports	2-15
	Backplane I/O Panel	2-15
	ATX PS/2 Keyboard/Mouse Ports	2-16
	Universal Serial Bus (USB)	2-17
	Ethernet Ports	2-18
	Back Panel High Definition Audio (HD Audio)	2-18
	Front Accessible Audio Header	2-19
	HDMI/DP Port	2-19
	VGA/DVI Port	2-20
	Front Control Panel	2-21
	Front Control Panel Pin Definitions	2-22

	Power LED	2-22
	HDD LED.....	2-22
	NIC1/NIC2 (LAN1/LAN2).....	2-23
	Overheat (OH)/Fan Fail.....	2-23
	Reset Button	2-24
	Power Button	2-24
2-7	Connecting Cables.....	2-25
	ATX Main PWR & CPU PWR Connectors (JPW1 & JPW2)	2-25
	Fan Headers (Fan 1 ~ Fan 5).....	2-26
	Chassis Intrusion (JL1)	2-26
	Internal Buzzer (SP1).....	2-27
	Speaker (JD1)	2-27
	Onboard Power LED (JLED1).....	2-28
	Serial Ports (COM1/COM2).....	2-28
	DOM PWR Connector (JSD1).....	2-29
	Wake-On-Ring (JWOR1).....	2-29
	SPDIF_Out (JSPDIF_OUT).....	2-30
	T-SGPIO 1/2 Headers	2-30
	TPM Header/Port 80 Header	2-31
	Standby Power Header.....	2-31
	IEEE 1394_1/1394_2 Connectors.....	2-32
2-8	Jumper Settings	2-33
	Explanation of Jumpers	2-33
	LAN1/LAN2 Enable/Disable	2-33
	CMOS Clear (JBT1).....	2-34
	PCI Slot SMB Enable (I ² C1/I ² C2).....	2-34
	IEEE 1394_1/2 Enable.....	2-35
	Front Panel Audio Enable (JPAC1).....	2-35
	HD Audio Enable (JHD_AC1)	2-35
	Manufacturer Mode Select	2-36
	Watch Dog Enable/Disable	2-37
	BIOS Recovery Enable (JBR1).....	2-37
2-9	Onboard Indicators.....	2-38
	LAN 1/LAN 2 LEDs	2-38
	Onboard Power LED (LED1)	2-38
2-10	SATA Connections.....	2-39
	SATA Connections (I-SATA0~I-SATA5).....	2-39

Chapter 3 Troubleshooting

3-1 Troubleshooting Procedures 3-1
3-2 Technical Support Procedures 3-3
3-3 Frequently Asked Questions 3-4
3-4 Battery Removal and Installation 3-5
3-5 Returning Merchandise for Service..... 3-6

Chapter 4 BIOS

4-1 Introduction..... 4-1
4-2 Main Setup..... 4-2
4-3 Advanced Setup Configurations..... 4-4
4-4 Event Logs 4-27
4-5 Boot Settings..... 4-29
4-6 Security Settings 4-31
4-7 Save & Exit 4-32

Appendix A BIOS Error Beep Codes

A-1 BIOS Error Beep Codes A-1

Appendix B Software Installation Instructions

B-1 Installing Software Programs B-1
B-2 Configuring SuperDoctor® III..... B-2

Appendix C UEFI BIOS Recovery Instructions

C-1 An Overview to the UEFI BIOS C-1
C-2 How to Recover the UEFI BIOS Image (the Main BIOS Block)..... C-1
C-3 To Recover the Main BIOS Block Using a USB-Attached Device..... C-1

Appendix D Dual Boot Block

D-1 Introduction..... D-1
D-2 Steps to Reboot the System by Using Jumper JBR1 D-2

Chapter 1

Introduction

1-1 Overview

Checklist

Congratulations on purchasing your computer motherboard from an acknowledged leader in the industry. Supermicro boards are designed with the utmost attention to detail to provide you with the highest standards in quality and performance.

Please check that the following items have all been included with your motherboard. If anything listed here is damaged or missing, contact your retailer.

The following items are included in the retail box:

- One (1) Supermicro Motherboard
- Six (6) SATA cables (Gift Box)
- One (1) I/O shield
- One (1) Driver CD (Gift Box)
- One (1) Quick Reference Guide



Note: For your system to work properly, please follow the links below to download all necessary drivers/utilities and the user's manual for your motherboard.

SMCI product manuals: <http://www.supermicro.com/support/manuals/>

Product Drivers and utilities: <ftp://ftp.supermicro.com/>

If you have any questions, please contact our support team at support@supermicro.com.

SUPER X10SAE Motherboard Image

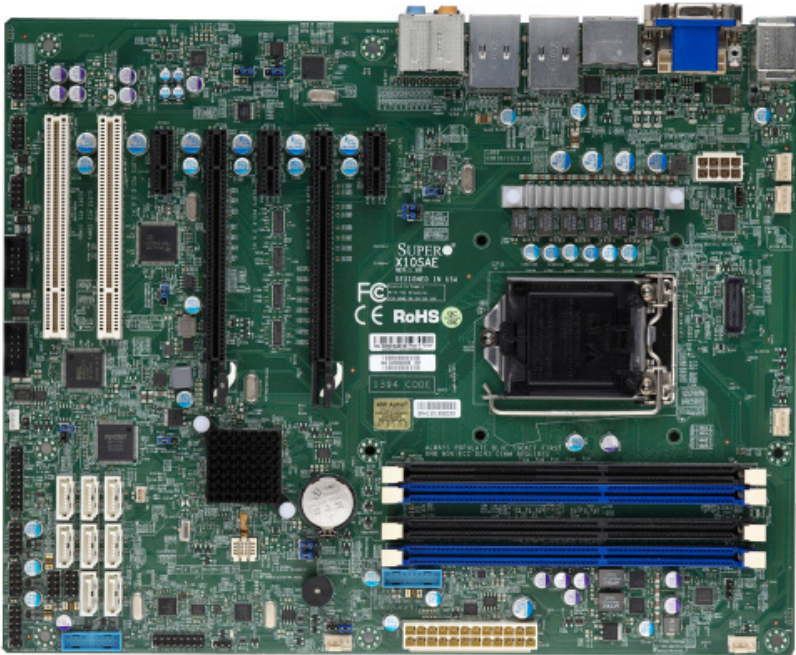

Note: All graphics shown in this manual were based upon the latest PCB Revision available at the time of publishing of the manual. The motherboard you've received may or may not look exactly the same as the graphics shown in this manual.

X10SAE Motherboard Layout

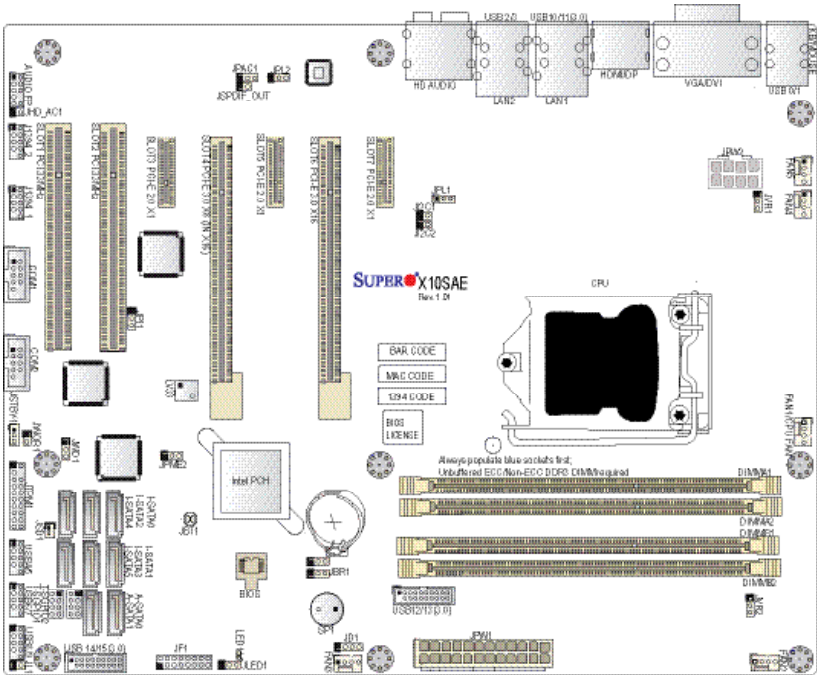

Important Notes to the User

- See Chapter 2 for detailed information on jumpers, I/O ports and JF1 front panel connections.
- "■" indicates the location of "Pin 1".
- Jumpers not indicated are for testing only.
- When LED1 (Onboard Power LED Indicator) is on, system power is on. Unplug the power cable before installing or removing any components.

X10SAE Quick Reference

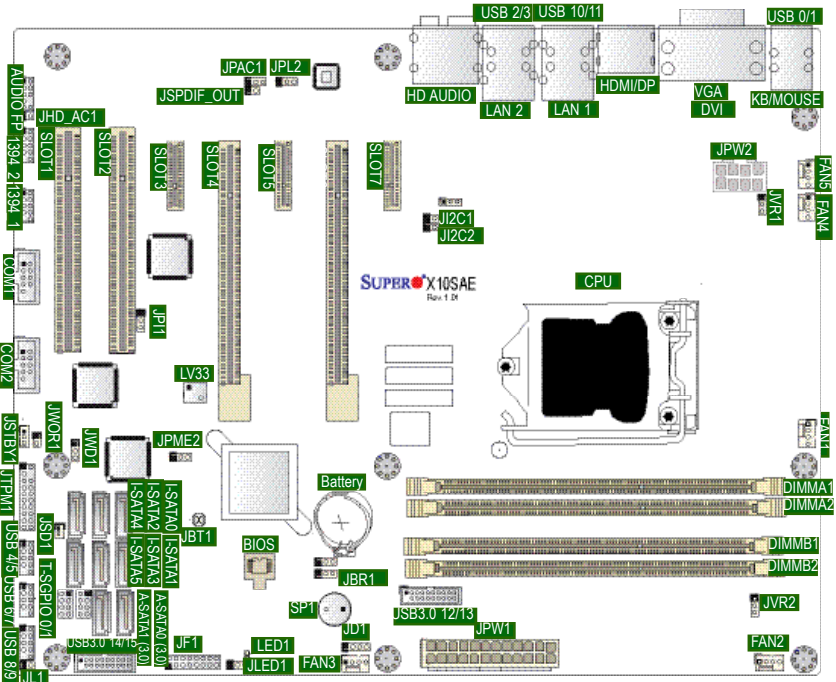

X10SAE Jumpers

Jumper	Description	Default
JBR1	BIOS Recovery Mode	Pins 1-2 (Normal)
JBT1	CMOS Clear	(See Chpt. 2)
J ¹ C1/J ¹ C2	SMB to PCI Slots	Off (Disabled)
JHD_AC1	High Definition (HD) Audio Enable	Pins 1-2 (Enabled)
JPAC1	Front Panel Audio Enable	Pins 1-2 (Enabled)
JPI1	1394_1/1394_2 Enable	Pins 1-2 (Enabled)
JPL1/JPL2	LAN1/LAN2 Enable	Pins 1-2 (Enabled)
JPME2	Management Enigne (ME) Manufacture Mode Select	Pins 1-2 (Normal)
JWD1	Watch Dog Enable	Pins 2-3 (NMI)

X10SAE Headers/Connectors

Connector	Description
1394_1/2	1394 Connectors 1/2
Audio FP	Front Panel Audio Header

HD AUDIO	High-Definition Audio Connectors (on the I/O back panel)
Battery	Onboard Battery
COM1/COM2	COM1/COM2 Port Headers
Fan1~Fan5	System/CPU Fan Headers (Fan1: CPU Fan)
HDMI/DP	Backplane HDMI(High-Definition Multimedia Interface)/DP Audio Port
JD1	Speaker/buzzer (Pins 3-4: Buzzer, Pins 1~4: External Speaker)
JF1	Front Panel Control Header
JL1	Chassis Intrusion Header
JLED1	Power LED Indicator Header
JPW1	24-pin ATX Main Power Connector (Required)
JPW2	+12V 8-pin CPU power Connector (Required)
JSD1	SATA DOM (Device_On_Module) Power Connector
JSPDIF_OUT	Sony/Philips Digital Interface (SPDIF)_Out Header
JSTBY1	Standby Power Header
JTPM1	Trusted Platform Module/Port 80 Connector
JVR1/JVR2	PWM SMB programming headers 1/2(for debugging only)
JWOR1	Wake_On-Ring Header
KB/Mouse	Keyboard/Mouse Connectors
LAN1/LAN2	Gigabit (RJ45) Ports (LAN1/2)
SP1	Internal Speaker/Buzzer
A-SATA0/A-SATA1	(ASMedia) Serial ATA (SATA 3.0) Ports 0/1 (6Gb/sec)
I-SATA0-I-SATA5	(Intel) Serial ATA (SATA 3.0) Ports 0-5 (6Gb/sec)
Slot 3/Slot 5/Slot 7	PCI-Express 2.0 x1 Slots
Slot 6	PCI-Express 3.0 x16 Slot
Slot 4	PCI-Express 3.0 x8 in x16 Slot
Slot 1, Slot 2	PCI 33MHz Slot (5V)
T-SGPIO 1/2	Serial_Link General Purpose I/O Connection Headers 1/2
USB 0/1, 2/3	Backpanel USB 2.0 Ports 0/1, 2/3
USB 10/11	Backpanel USB 3.0 Ports 10/11
USB 4/5, USB 6/7, USB 8/9	Front Panel Accessible USB 2.0 Headers 4/5, 6/7, 8/9
USB 3.0 12/13, 14/15	Front Panel Accessible USB 3.0 Headers 12/13, 14/15
VGA/DVI	Backpanel VGA/DVI (Digital Video Interface) Port

X10SAE LED Indicators

LED	Description	Color/State	Status
LED1	Onboard Standby PWR LED	Green: Solid on	Power On

Motherboard Features

CPU	Single Intel® Xeon E3-1200V3 series processor or 4th Generation Intel® Core™ i7/i5/i3 DT processor in an LGA1150 socket	
Memory	Four (4) SDRAM slots support up to 32 GB of DDR3 Unbuffered ECC/Non-ECC 1600/1333/1066 MHz memory	
	Single-channel memory	
	DIMM sizes	
	UDIMM	1 GB, 2 GB, 4GB, and 8GB
Chipset	Intel® C226 Express	
Expansion Slots	Three (3) PCI Express 2.0 x1 slots (Slot 3/Slot 5/Slot 7)	
	One (1) PCI Express 3.0 x8 in x16 slot (Slot 4)	
	One (1) PCI Express 3.0 x16 slot (Slot 6)	
	Two (2) PCI 33 MHz slots (5 Volts) (Slot 1, Slot 2)	
Network Connections	Two (2) Gigabit Ethernet Controllers: LAN1: Intel i217 gigabit LAN controller LAN2: Intel i210 gigabit LAN controller	
	Two (2) RJ-45 rear I/O panel connectors with Link and Activity LEDs	
I/O Devices	SATA Connections	
	SATA 3.0 (6Gb/s)	Two (2) A-SATA 0/1 via ASM1061
	SATA 3.0 (6Gb/s)	Six (6) I-SATA 0-5 via Intel C226 PCH
		RAID 0, 1, 5, 10
	USB Devices	
	Four (4) USB 2.0 ports on the rear I/O panel (USB 0/1, 2/3), Two (2) USB 3.0 ports on the rear I/O panel (USB 10/11)	
	Six (6) Front Accessible USB 2.0 ports on three headers (USB 4/5, 6/7, 8/9), Four (4) Front Accessible USB 3.0 ports on two headers (USB 12/13, 14/15)	
	Keyboard/Mouse	
	One shared PS/2 Keyboard/Mouse port on the I/O backpanel	
	Serial (COM) Ports	
Two (2) front accessible Serial Port headers (COM1/ COM2)		

	Audio One (1) High Definition Multimedia Interface (HDMI)/DP on the back panel, One (1) High Definition Audio 7.1 channel connector supported by Realtek ALC1150 on the back panel One (1) Front Panel Audio Header One (1) SPDIF_Out on the rear side of the chassis Super I/O Nuvoton NCT6776D
BIOS	128 Mb AMI BIOS® SPI Flash BIOS Plug and Play (PnP), DMI 2.3, PCI 2.2, ACPI 1.0/2.0, USB Keyboard and SMBIOS 2.5
Power Configuration	ACPI/ACPM Power Management Main Switch Override Mechanism Keyboard Wake-up from Soft-Off Internal/External Modem Ring-On Power-on mode for AC power recovery
PC Health Monitoring	CPU Monitoring Onboard voltage monitors for CPU core, +3.3V, +5V,-12V, +12V, VBAT, Memory, VCORE for CPU CPU 6-phase switching voltage regulator CPU/System overheat LED and control CPU Thermal Trip support Thermal Monitor 2 (TM2) support vPro 9.0/AMT 9.0 support Fan Control Low noise fan speed control
System Management	PECI (Platform Environment Configuration Interface) 2.0 support System resource alert via SuperDoctor® III SuperDoctor® III, Watch Dog, NMI Chassis Intrusion header and detection
CD Utilities	BIOS flash upgrade utility
Other	ROHS 6/6 (Full Compliance, Lead Free)
Dimensions	ATX form factor (12.0" x 9.6") (304.8 mm x 243.84 mm)

X10SAE Block Diagram

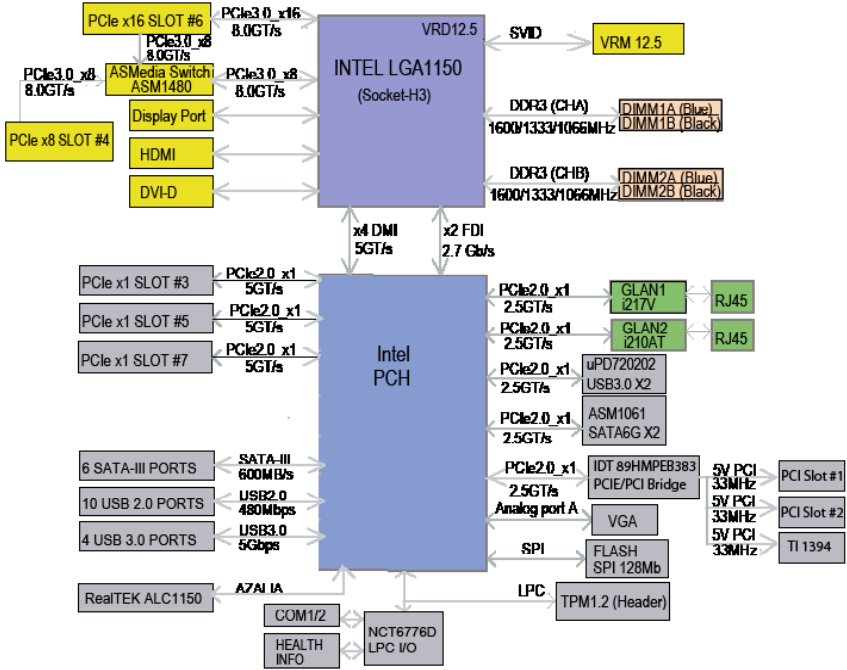

System Block Diagram



Note: This is a general block diagram and may not exactly represent the features on your motherboard. See the Motherboard Features pages for the actual specifications of each motherboard.

1-2 Chipset Overview

The X10SAE supports a single Intel® Xeon E3-1200V3 series processor or a 4th Generation Intel® Core i7/i5/i3 DT processor in the LGA 1150 Socket. Built upon the functionality and the capability of the C226 Express chipset, the motherboard provides substantial enhancement to system performance and storage capability for high performance platforms in a sleek package.

The high-speed Direct Media Interface (DMI) featured in the Intel C226 Express chipset supports high-speed Direct Media Interface (DMI) for chip-to-chip true isochronous communication, providing up to 20 Gb/s of software-transparent data transfer rate on each read/write direction. In addition, the X10SAE also features a TCO timer which allows the system to recover from a software/hardware lock and perform tasks, including Function Disable and Intruder Detect.

Intel C226 Express Chipset Features

- Direct Media Interface (up to 20 Gb/s transfer, Full Duplex)
- Intel® Matrix Storage Technology and Intel Rapid Storage Technology
- Dual NAND Interface
- Intel I/O Virtualization (VT-d) Support
- Intel Trusted Execution Technology Support
- PCI Express 2.0/3.0 Interface (up to 5.8 GT/s)
- SATA Controller (up to 6Gb/sec)
- Advanced Host Controller Interface (AHCI)
- Intel Active Management Technology (iAMT) 9.0 and vPRO 9.0 support

1-3 Special Features

Recovery from AC Power Loss

Basic I/O System (BIOS) provides a setting for you to determine how the system will respond when AC power is lost and then restored to the system. You can choose for the system to remain powered off, (in which case you must press the power switch to turn it back on), or for it to automatically return to a power-on state. See the Advanced BIOS Setup section to change this setting. The default setting is **Last State**.

1-4 PC Health Monitoring

This section describes the PC health monitoring features of the board. All have an onboard System Hardware Monitoring chip that supports PC health monitoring. An onboard voltage monitor will scan these onboard voltages continuously: CPU Vcore, 12V, -12V, 5V, 3.3V, and Battery voltages. Once a voltage becomes unstable, a warning is given, or an error message is sent to the screen. The user can adjust the voltage thresholds to define the sensitivity of the voltage monitor.

Environmental Temperature Control

This motherboard supports 4-pin fans. The fourth pin of a 4-pin fan supports Pulse Width Modulation, which allows the BIOS to monitor the CPU temperature in real time. A thermal control fan will be turned on whenever the CPU temperature exceeds a user-defined threshold. The onboard chassis thermal circuitry can also monitor the overall system temperature and alert the user when the chassis temperature is too high.



Note: To avoid possible system overheating, please be sure to provide adequate airflow to your system.

System Resource Alert

This feature is available when the system is used with SuperDoctor[®] III in the Windows OS environment or used with SuperDoctor II in Linux. SuperDoctor is used to notify the user of certain system events. For example, you can also configure SuperDoctor to provide you with warnings when the system temperature, CPU temperatures, voltages and fan speeds go beyond predefined thresholds.

1-5 ACPI Features

ACPI stands for Advanced Configuration and Power Interface. The ACPI specification defines a flexible and abstract hardware interface that provides a standard way to integrate power management features throughout a PC system, including its hardware, operating system and application software. This enables the system to automatically turn on and off peripherals such as CD-ROMs, network cards, hard disk drives and printers.

In addition to enabling operating system-directed power management, ACPI also provides a generic system event mechanism for Plug and Play, and an operating system-independent interface for configuration control. ACPI leverages the Plug and Play BIOS data structures, while providing a processor architecture-independent implementation that is compatible with Windows 7, Windows 8, and Windows 2008 Operating Systems.

Slow Blinking LED for Suspend-State Indicator

When the CPU goes into a suspend state, the chassis power LED will start to blink to indicate that the CPU is in suspend mode. When the user presses any key, the CPU will "wake up", and the LED will automatically stop blinking and remain on.

1-6 Power Supply

As with all computer products, a stable power source is necessary for proper and reliable operation. It is even more important for processors that have high CPU clock rates.

This motherboard accommodates 24-pin ATX power supplies. Although most power supplies generally meet the specifications required by the CPU, some are inadequate. In addition, the 12V 8-pin power connector located at JPW2 is also required to ensure adequate power supply to the system. Also your power supply must supply 1.5A for the Ethernet ports.

Warning: 1. To prevent damage to the power supply or motherboard, please use a power supply that contains a 24-pin and a 8-pin power connectors. Be sure to connect these connectors to the 24-pin (JPW1) and the 8-pin (JPW2) power connectors on the motherboard. Failure in doing so will void the manufacturer warranty on your power supply and motherboard. 2. To provide adequate power to a disk-on-module (DOM) device, please connect it to the DOM power connector located at JSD1.

It is strongly recommended that you use a high quality power supply that meets ATX power supply Specification 2.02 or above. It must also be SSI compliant. (For more information, please refer to the web site at <http://www.ssiforum.org/>). Additionally, in areas where noisy power transmission is present, you may choose to install a line filter to shield the computer from noise. It is recommended that you also install a power surge protector to help avoid problems caused by power surges.

1-7 Super I/O

The Super I/O provides functions that comply with ACPI (Advanced Configuration and Power Interface), which includes support of legacy and ACPI power management through an SMI or SCI function pin. It also features auto power management to reduce power consumption.

Chapter 2

Installation

2-1 Standardized Warning Statements

The following statements are industry-standard warnings, provided to warn the user of situations which have the potential for bodily injury. Should you have questions or experience difficulty, contact Supermicro's Technical Support department for assistance. Only certified technicians should attempt to install or configure components. Read this section in its entirety before installing or configuring components in the Supermicro chassis.

Battery Handling



Warning!

There is a danger of explosion if the battery is replaced incorrectly. Replace the battery only with the same or equivalent type recommended by the manufacturer. Dispose of used batteries according to the manufacturer's instructions

電池の取り扱い

電池交換が正しく行われなかった場合、破裂の危険性があります。交換する電池はメーカーが推奨する型、または同等のものを使用下さい。使用済電池は製造元の指示に従って処分して下さい。

警告

電池更換不當會有爆炸危險。請只使用同類電池或制造商推薦的功能相當的電池更換原有電池。請按製造商的說明處理廢舊電池。

警告

電池更換不當會有爆炸危險。請使用製造商建議之相同或功能相當的電池更換原有電池。請按照製造商的說明指示處理廢棄舊電池。

Warnung

Bei Einsetzen einer falschen Batterie besteht Explosionsgefahr. Ersetzen Sie die Batterie nur durch den gleichen oder vom Hersteller empfohlenen Batterietyp. Entsorgen Sie die benutzten Batterien nach den Anweisungen des Herstellers.

Attention

Danger d'explosion si la pile n'est pas remplacée correctement. Ne la remplacer que par une pile de type semblable ou équivalent, recommandée par le fabricant. Jeter les piles usagées conformément aux instructions du fabricant.

¡Advertencia!

Existe peligro de explosión si la batería se reemplaza de manera incorrecta. Reemplazar la batería exclusivamente con el mismo tipo o el equivalente recomendado por el fabricante. Desechar las baterías gastadas según las instrucciones del fabricante.

אזהרה!

קיימת סכנת פיצוץ של הסוללה במידה והוחלפה בדרך לא תקינה. יש להחליף את הסוללה בסוג התואם מחברת יצרן מומלצת.

סילוק הסוללות המשומשות יש לבצע לפי הוראות היצרן.

هناك خطر من انفجار في حالة استبدال البطارية بطريقة غير صحيحة فعليك استبدال البطارية فقط بنفس النوع أو ما يعادلها كما أوصت به الشركة المصنعة تخلص من البطاريات المستعملة وفقا لتعليمات الشركة الصانعة

경고!

배터리가 올바르게 교체되지 않으면 폭발의 위험이 있습니다. 기존 배터리와 동일하거나 제조사에서 권장하는 동등한 종류의 배터리로만 교체해야 합니다. 제조사의 안내에 따라 사용된 배터리를 처리하여 주십시오.

Waarschuwing

Er is ontploffingsgevaar indien de batterij verkeerd vervangen wordt. Vervang de batterij slechts met hetzelfde of een equivalent type die door de fabrikant aanbevolen wordt. Gebruikte batterijen dienen overeenkomstig fabrieksvoorschriften afgevoerd te worden.

Product Disposal



Warning!

Ultimate disposal of this product should be handled according to all national laws and regulations.

製品の廃棄

この製品を廃棄処分する場合、国の関係する全ての法律・条例に従い処理する必要があります。

警告

本产品的废弃处理应根据所有国家的法律和规章进行。

警告

本產品的廢棄處理應根據所有國家的法律和規章進行。

Warnung

Die Entsorgung dieses Produkts sollte gemäß allen Bestimmungen und Gesetzen des Landes erfolgen.

¡Advertencia!

Al deshacerse por completo de este producto debe seguir todas las leyes y reglamentos nacionales.

Attention

La mise au rebut ou le recyclage de ce produit sont généralement soumis à des lois et/ou directives de respect de l'environnement. Renseignez-vous auprès de l'organisme compétent.

סילוק המוצר

אזהרה!

סילוק סופי של מוצר זה חייב להיות בהתאם להנחיות וחוקי המדינה.

عند التخلص النهائي من هذا المنتج ينبغي التعامل معه وفقا لجميع القوانين واللوائح الوطنية

경고!

이 제품은 해당 국가의 관련 법규 및 규정에 따라 폐기되어야 합니다.

Waarschuwing

De uiteindelijke verwijdering van dit product dient te geschieden in overeenstemming met alle nationale wetten en reglementen.

2-2 Static-Sensitive Devices

Electrostatic-Discharge (ESD) can damage electronic components. To avoid damaging your system board, it is important to handle it very carefully. The following measures are generally sufficient to protect your equipment from ESD.

Precautions

- Use a grounded wrist strap designed to prevent static discharge.
- Touch a grounded metal object before removing the board from the antistatic bag.
- Handle the board by its edges only; do not touch its components, peripheral chips, memory modules or gold contacts.
- When handling chips or modules, avoid touching their pins.
- Put the motherboard and peripherals back into their antistatic bags when not in use.
- For grounding purposes, make sure your computer chassis provides excellent conductivity between the power supply, the case, the mounting fasteners and the motherboard.
- Use only the correct type of onboard CMOS battery. Do not install the onboard battery upside down to avoid possible explosion.

Unpacking

The motherboard is shipped in antistatic packaging to avoid static damage. When unpacking the board, make sure that the person handling it is static protected.

2-3 Processor and Heatsink Installation

Warning: When handling the processor package, avoid placing direct pressure on the label area of the fan.



Important:

- Always connect the power cord last, and always remove it before adding, removing or changing any hardware components. Make sure that you install the processor into the CPU socket before you install the CPU heatsink.
- If you buy a CPU separately, make sure that you use an Intel-certified multi-directional heatsink only.
- Make sure to install the system board into the chassis before you install the CPU heatsink.
- When receiving a server board without a processor pre-installed, make sure that the plastic CPU socket cap is in place and none of the socket pins are bent; otherwise, contact your retailer immediately.
- Refer to the Supermicro website for updates on CPU support.

Installing the LGA1150 Processor

1. Gently press down the load plate handle and push it outward (to the right side) to unlock it.
2. Once the load plate handle is unlocked, gently lift the handle to open the load plate.

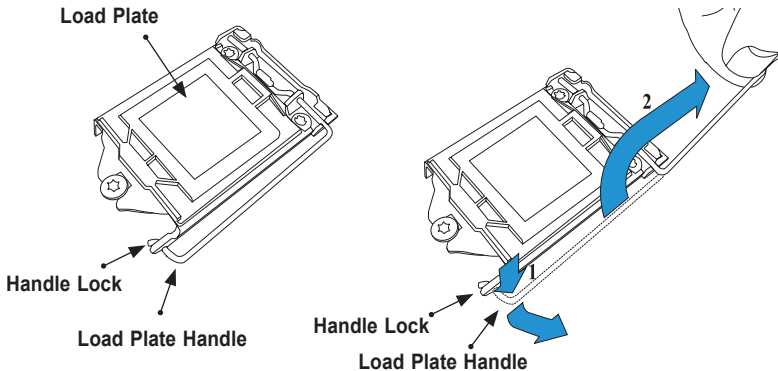

3. Once the load plate is open, use your thumb and your index finger to hold the CPU at the north center edge and the south center edge of the CPU.

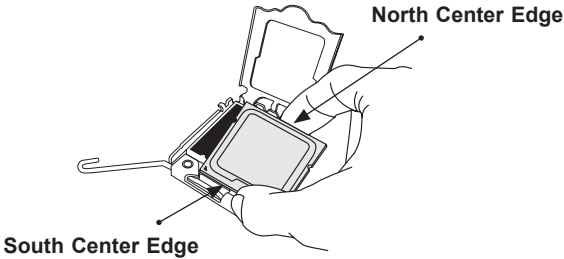

4. Align the CPU keys, which are the semicircular cutouts on the sides of the CPU (shown below), against the socket keys, the semicircular notches on the sides of the CPU socket. Align CPU Pin 1, the triangle at the bottom left of the CPU, against Pin 1 of the socket, the triangle marker at the bottom left of the CPU socket.

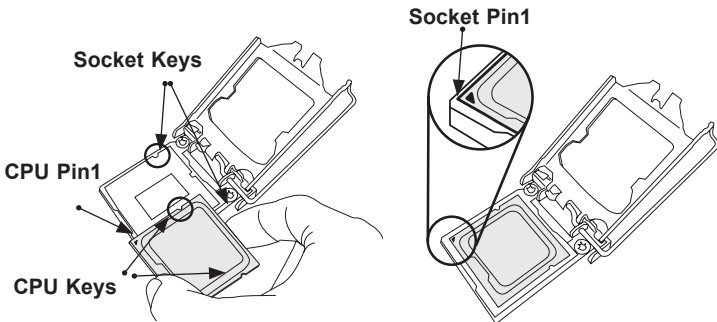

5. Once they are aligned, carefully lower the CPU straight down into the socket. (To avoid damaging the CPU or the socket, do not drop the CPU on the socket. Do not rub the CPU against the surface or against any pins of the socket.)
6. With the CPU seated inside the socket, inspect the four corners of the CPU to ensure that it is properly installed.

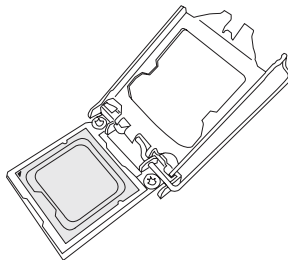

7. Once the CPU is properly installed, use your thumb to gently push the load plate handle down to the handle lock and lock it.

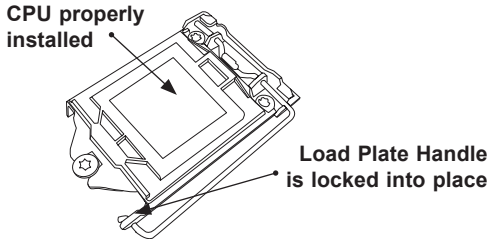

8. When the CPU is securely locked into the CPU socket, the plastic cap will be automatically loosened from the load plate. Use your thumb and index finger to remove the plastic cap from the socket.

The plastic cap will pop open when the CPU is properly installed in the socket. Remove the cap from the socket.

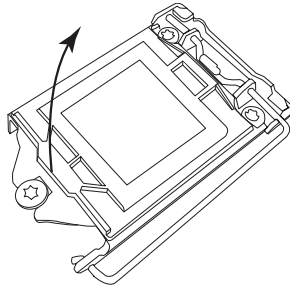

Warning: You can install the CPU inside the socket only in one direction. Make sure that it is properly inserted into the CPU socket before closing the load plate. If it doesn't close properly, do not force it, as that may damage your CPU. Instead, open the load plate again and check whether the CPU is properly aligned and securely seated inside the socket.

Installing a Passive CPU Heatsink

1. Do not apply thermal grease to the heatsink or the CPU die; the required amount has already been applied.
2. Place the heatsink on top of the CPU so that the four mounting holes are aligned with those on the motherboard and the underlying heatsink bracket.
3. Screw in two diagonal screws (the #1 and #2 screws in the figure below) until just snug. To avoid possible damage to the CPU, do not over tighten the screws.
4. Finish the installation by fully tightening all four screws.

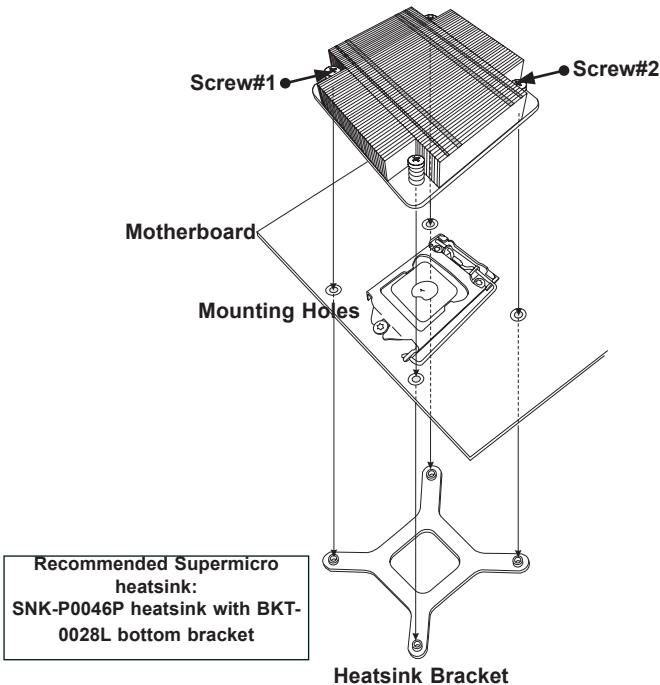

Removing the Heatsink

Warning: We do not recommend that the CPU or the heatsink be removed. However, if you do need to uninstall the heatsink, please follow the instructions below to remove the heatsink to avoid damaging the CPU or the CPU socket.

1. Unscrew the heatsink screws from the motherboard in the sequence as shown in the figure below.
2. Gently wriggle the heatsink to loosen it from the CPU. (Do not use excessive force)
3. Once the CPU is loosened, remove the CPU from the CPU socket.
4. Clean the surface of the CPU and the heatsink, removing any thermal grease. Reapply the proper amount of fresh thermal grease on the surface before reinstalling the CPU and the heatsink.

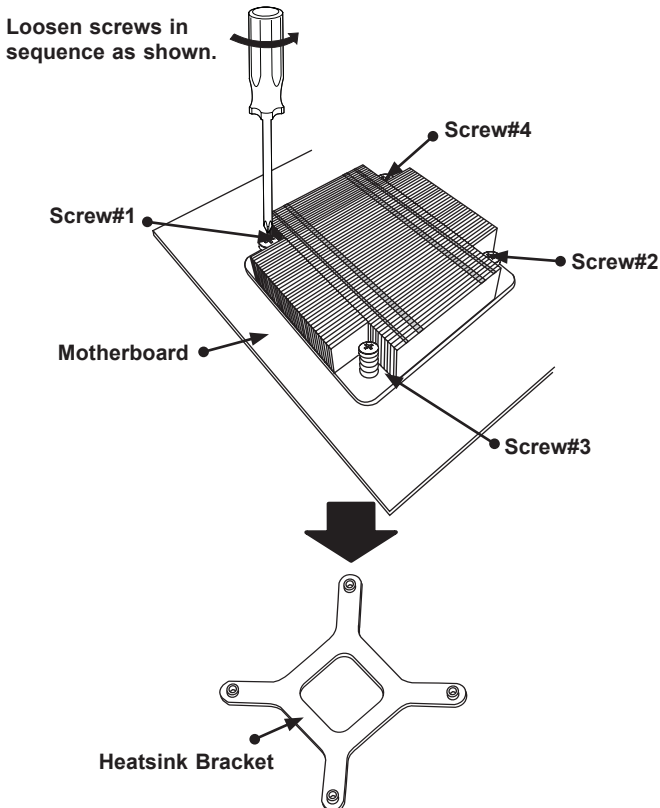

2-4 Installing DDR3 Memory

 **Note:** Check the Supermicro website for recommended memory modules.

CAUTION

Exercise extreme care when installing or removing DIMM modules to prevent any possible damage.

DIMM Installation

1. Insert the desired number of DIMMs into the memory slots, starting with the blue slots first: DIMMA2 and DIMMB2, then DIMMA1 and DIMMB1. For the system to work properly, please use the memory modules of the same type and speed in the same motherboard.
2. Push the release tabs outwards on both ends of the DIMM slot to unlock it.
3. Align the key of the DIMM module with the receptive point on the memory slot.
4. Align the notches on both ends of the module against the receptive points on the ends of the slot.
5. Use two thumbs together to press the notches on both ends of the module straight down into the slot until the module snaps into place.
6. Press the release tabs to the lock positions to secure the DIMM module into the slot.

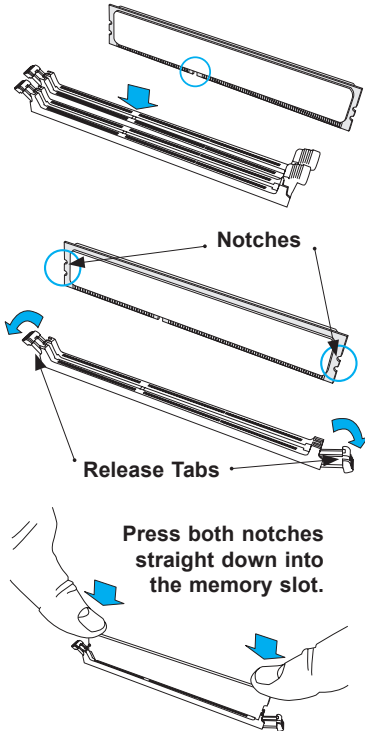
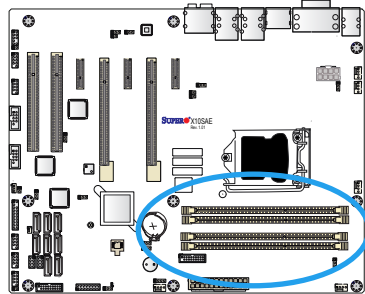

Removing Memory Modules

Reverse the steps above to remove the DIMM modules from the motherboard.

Memory Support

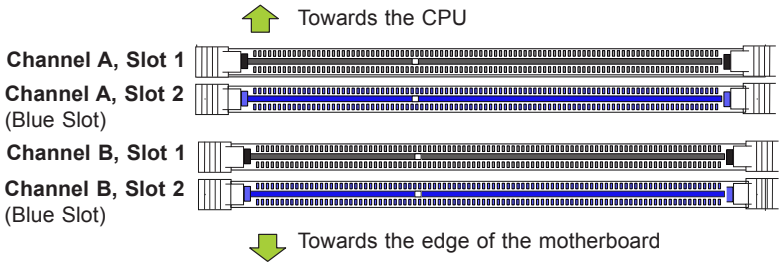

The X10SAE supports up to 32GB of Unbuffered (UDIMM) DDR3 ECC/Non-ECC 1600/1333/1066 MHz in four memory slots. Populating these DIMM modules with a pair of memory modules of the same type and same size will result in interleaved memory, which will improve memory performance. Please refer to the table below:

Memory Population Guidelines

Please follow the table below when populating the X10SAE.

Max Memory Possible	1Gb DRAM Technology	2Gb DRAM Technology	4Gb DRAM Technology
Single Rank UDIMM	4GB (4x1GB DIMMs)	8GB (4x2GB DIMMs)	16GB (4x4GB DIMMs)
Dual Rank UDIMMs	8GB (4x2GB DIMMs)	16GB (4x4GB DIMMs)	32GB (4x8GB DIMMs)



Notes

- Be sure to use memory modules of the same type, same speed, same frequency on the same motherboard. Mixing of memory modules of different types and speeds is not allowed.
- Due to memory allocation to system devices, the amount of memory that remains available for operational use will be reduced when 4 GB of RAM is used. The reduction in memory availability is disproportional. See the following table for details.

- For Microsoft Windows users: Microsoft implemented a design change in the Windows XP with Service Pack 2 (SP2) and Windows Vista. This change is specific to the behavior of Physical Address Extension (PAE) mode which improves driver compatibility. For more information, please read the following article at Microsoft's Knowledge Base website at: <http://support.microsoft.com/kb/888137>.

Possible System Memory Allocation & Availability

System Device	Size	Physical Memory Remaining (-Available) (4 GB Total System Memory)
Firmware Hub flash memory (System BIOS)	1 MB	3.99
Local APIC	4 KB	3.99
Area Reserved for the chipset	2 MB	3.99
I/O APIC (4 Kbytes)	4 KB	3.99
PCI Enumeration Area 1	256 MB	3.76
PCI Express (256 MB)	256 MB	3.51
PCI Enumeration Area 2 (if needed) -Aligned on 256-MB boundary-	512 MB	3.01
VGA Memory	16 MB	2.85
TSEG	1 MB	2.84
Memory available to OS and other applications		2.84

2-5 Motherboard Installation

All motherboards have standard mounting holes to fit different types of chassis. Make sure that the locations of all the mounting holes for both motherboard and chassis match. Although a chassis may have both plastic and metal mounting fasteners, metal ones are highly recommended because they ground the motherboard to the chassis. Make sure that the metal standoffs click in or are screwed in tightly. Then use a screwdriver to secure the motherboard onto the motherboard tray.

Tools Needed



Philips Screwdriver
(1)



Philips Screws (9)



Standoffs (9)
Only if Needed

Location of Mounting Holes

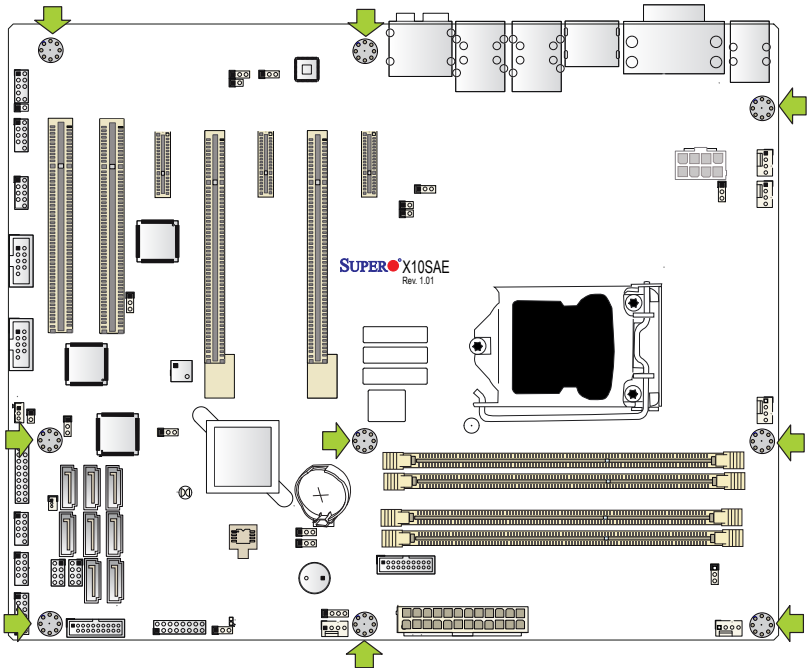

Caution: 1) To avoid damaging the motherboard and its components, please do not use a force greater than 8 lb/inch on each mounting screw during motherboard installation. 2) Some components are very close to the mounting holes. Please take precautionary measures to avoid damaging these components when installing the motherboard to the chassis.

Installing the Motherboard

1. Install the I/O shield into the back of the chassis.

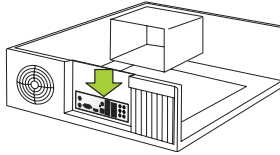

2. Locate the mounting holes on the motherboard. (See the previous page.)
3. Locate the matching mounting holes on the chassis. Align the mounting holes on the motherboard against the mounting holes on the chassis.
4. Install standoffs in the chassis as needed.

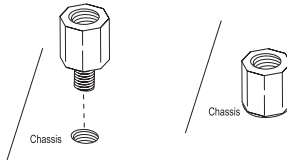

5. Install the motherboard into the chassis carefully to avoid damaging other motherboard components.
6. Using the Phillips screwdriver, insert a Phillips head #6 screw into a mounting hole on the motherboard and its matching mounting hole on the chassis.

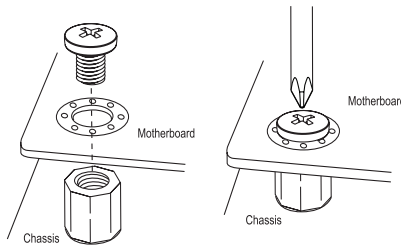

7. Repeat Step 5 to insert #6 screws into all mounting holes.
8. Make sure that the motherboard is securely placed in the chassis.

 **Note:** Images displayed are for illustration only. Your chassis or components might look different from those shown in this manual.

2-6 Connectors/I/O Ports

The I/O ports are color coded in conformance with the industry standards. See the figure below for the colors and locations of the various I/O ports.

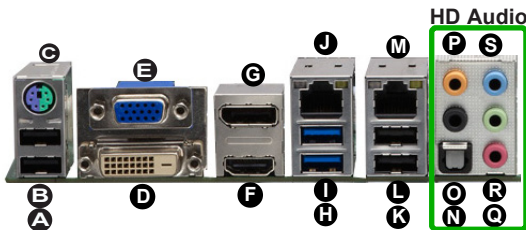
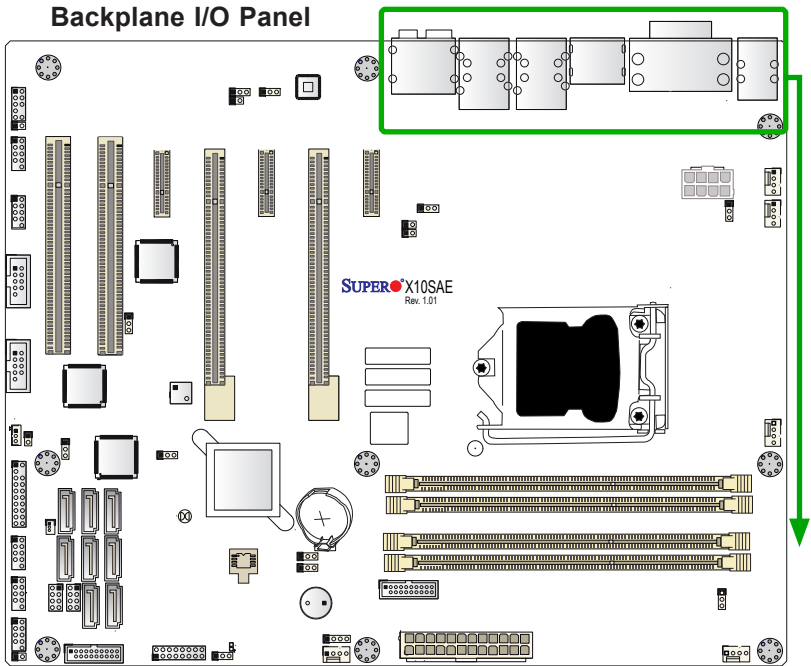

Backplane I/O Panel		
A. USB 2.0 Port 0	G. Display/Port Connector	N. SPDIF Out
B. USB 2.0 Port 1	H. USB 3.0 Port 10	O. Surround Out
C. Keyboard/Mouse	I. USB 3.0 Port 11	P. Center/LFE Out
D. DVI Port	J. Gb LAN Port 1	Q. Mic In
E. VGA Port	K. USB 2.0 Port 2	R. Line Out
F. HDMI Port	L. USB 2.0 Port 3	S. Line In
		(N-S: HD Audio Jacks)

ATX PS/2 Keyboard/Mouse Ports

The ATX PS/2 keyboard and PS/2 mouse are located above Back Panel USB Ports 0/1 on the motherboard. See the table at right for pin definitions.

PS/2 Keyboard/Mouse Pin Definitions			
PS2 Keyboard		PS2 Mouse	
Pin#	Definition	Pin#	Definition
1	KB Data	1	Mouse Data
2	No Connection	2	No Connection
3	Ground	3	Ground
4	Mouse/KB VCC (+5V)	4	Mouse/KB VCC (+5V)
5	KB Clock	5	Mouse Clock
6	No Connection	6	No Connection

VCC: with 1.5A PTC (current limit)

Note:

This motherboard offers three Keyboard/Mouse connection options as shown in the graphic below.

- **A.** Plug in a PS/2 keyboard or PS/2 Mouse cable to the PS/2 Keyboard/Mouse port.
- **B.** Plug in a Y cable that that includes a keyboard cable and mouse cable to the PS/2 Keyboard/Mouse port..
- **C.** Connect a USB keyboard cable or a USB mouse cable to any USB port.

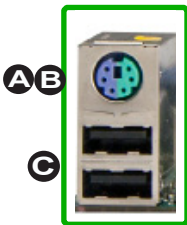

Keyboard/Mouse

(For a PS/2 keyboard cable, a PS/2 Mouse cable or a PS/2 Y cable) (optional)

(For a USB keyboard cable or a USB mouse cable, in any USB port) (optional)

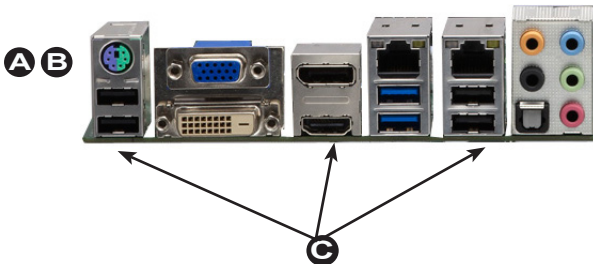

Universal Serial Bus (USB)

Four Universal Serial Bus 2.0 ports (0/1, 2/3) and two USB 3.0 ports (10/11) are located on the I/O back panel. In addition, three USB 2.0 headers (six USB 2.0 connections: 4/5, 6/7, 8/9), and two USB 3.0 headers (four USB 3.0 connections: 12/13, 14/15) are also located on the motherboard to provide front chassis access using USB cables (not included). See the tables below for pin definitions.

Front Panel USB (2.0) #4/5, 6/7, 8/9 Pin Definitions			
Pin #	Definition	Pin #	Definition
1	+5V	2	+5V
3	USB_PN2	4	USB_PN3
5	USB_PP2	6	USB_PP3
7	Ground	8	Ground
9	Key	10	Ground

Back Panel USB (2.0) #0/1, 2/3 Pin Definitions			
Pin#	Definition	Pin#	Definition
1	+5V	5	+5V
2	USB_PN1	6	USB_PN0
3	USB_PP1	7	USB_PP0
4	Ground	8	Ground

Front Panel USB (3.0) #10/11, 12/13, 14/15 Pin Definitions			
Pin#	Pin#	Signal Name	Description
1	10	VBUS	Power
2	11	D-	USB 2.0 Differential Pair
3	12	D+	
4	13	Ground	Ground of PWR Return
5	14	StdA_SSRX-	SuperSpeed Receiver
6	15	StdA_SSRX+	Differential Pair
7	16	GND_DRAIN	Ground for Signal Return
8	17	StdA_SSTX-	SuperSpeed Transmitter
9	18	StdA_SSTX+	Differential Pair

- [A. Backpanel USB 2.0 #0](#)
- [B. Backpanel USB 2.0 #1](#)
- [C. Backpanel USB 3.0 #10](#)
- [D. Backpanel USB 3.0 #11](#)
- [E. Backpanel USB 2.0 #2](#)
- [F. Backpanel USB 2.0 #3](#)
- [G. Front Panel USB 2.0 #4/5](#)
- [H. Front Panel USB 2.0 #6/7](#)
- [I. Front Panel USB 2.0 #8/9](#)
- [J. Front Panel USB 3.0 #12/13](#)
- [K. Front Panel USB 3.0 #14/15](#)

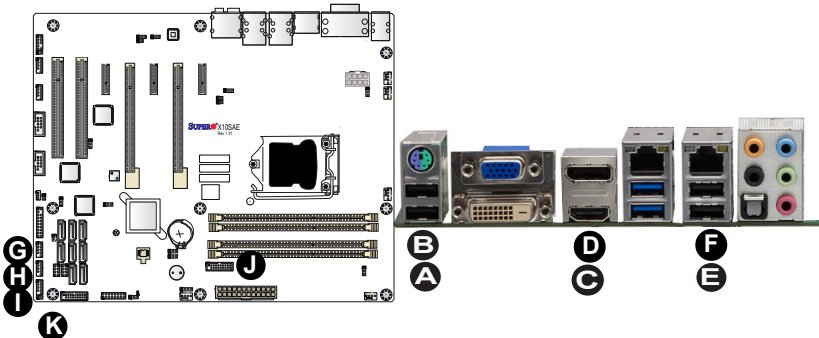

Ethernet Ports

Two Gigabit Ethernet ports (LAN1/ LAN2) are located next to the HD Audio Connector on the I/O Backpanel to provide network connections. These ports accept RJ45 type cables.

 **Note:** Please refer to the LED Indicator Section for LAN LED information.

LAN Ports Pin Definition			
Pin#	Definition		
1	P2V5SB	10	SGND
2	TD0+	11	Act LED
3	TD0-	12	P3V3SB
4	TD1+	13	Link 100 LED (Green, +3V3SB)
5	TD1-	14	Link 1000 LED (Yellow, +3V3SB)
6	TD2+	15	Ground
7	TD2-	16	Ground
8	TD3+	17	Ground
9	TD3-	88	Ground

(NC: No Connection)

Back Panel High Definition Audio (HD Audio)

This motherboard features a 7.1+2 Channel High Definition Audio (HDA) codec that provides 10 DAC channels. The HD Audio connections simultaneously supports multiple-streaming 7.1 sound playback with 2 channels of independent stereo output through the front panel stereo out for front, rear, center and subwoofer speakers. Use the Advanced software included in the CD-ROM with your motherboard to enable this function.

(BP) HD Audio	
Conn#	Signal
A	SPDIF_Out
B	Surround_Out
C	CEN/LFE_Out
D	Mic_In
E	Line_Out
F	Line_In



- A. LAN1
- B. LAN2
- C. SPDIF_Out
- D. Surround_Out
- E. CEN/LFE_Out
- F. Mic_In
- G. Line-Out
- H. Line_In

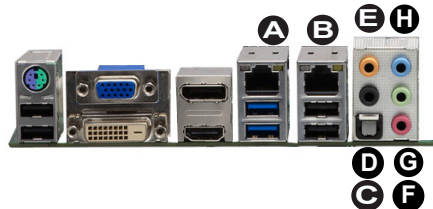
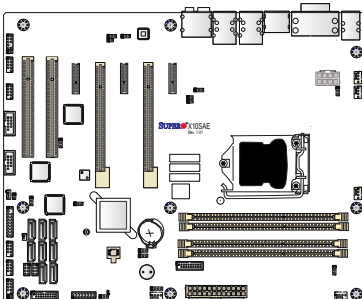

Front Accessible Audio Header

A 10-pin Audio header is also located on the motherboard. This header allows you to use the onboard sound for audio playback. Connect an audio cable to the audio header to use this feature. See the table at right for pin definitions for the header.

10-in Audio Pin Definitions	
Pin#	Signal
1	Microphone_Left
2	Audio_Ground
3	Microphone_Right
4	Audio_Detect
5	Line_2_Right
6	Ground
7	Jack_Detect
8	Key
9	Line_2_Left
10	Ground

HDMI/DP Port

One HDMI (High-Definition Multimedia Interface)/DP port is located next to the VGA port on the I/O backpanel. This connector is used to display both high definition video and digital sound through an HDMI/DP-capable display, using a single HDMI/DP cable (not included).

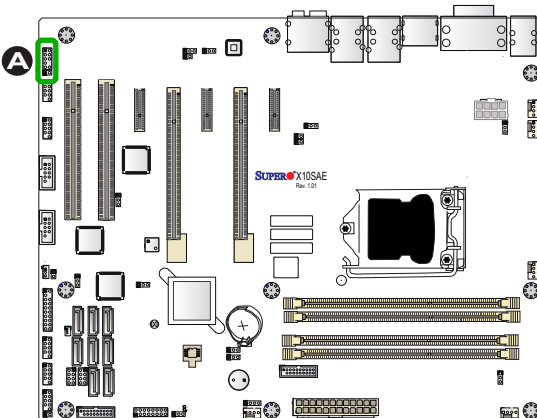

A. Audio Header

B. HDMI/DP Port

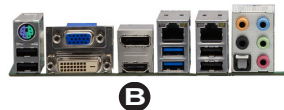

VGA/DVI Port

A VGA/DVI port is located next to the USB ports 0/1 on the I/O backpanel. Use this port to connect to a compatible VGA/DVI display.

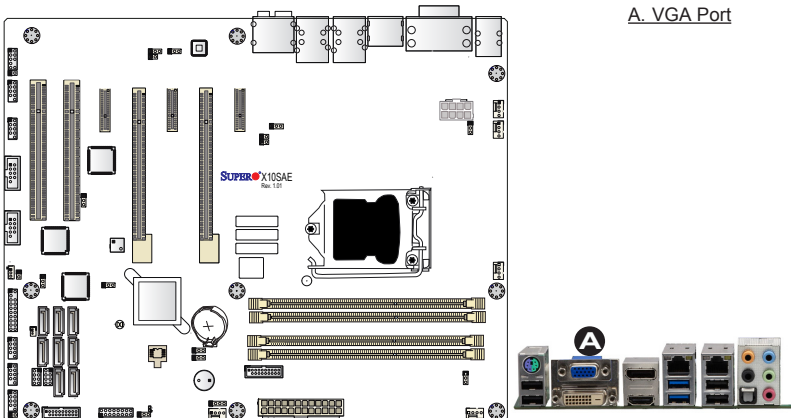

A. VGA Port

Front Control Panel

JF1 contains header pins for various buttons and indicators that are normally located on a control panel at the front of the chassis. These connectors are designed specifically for use with Supermicro chassis. See the figure below for the descriptions of the front control panel buttons and LED indicators. Refer to the following section for descriptions and pin definitions.

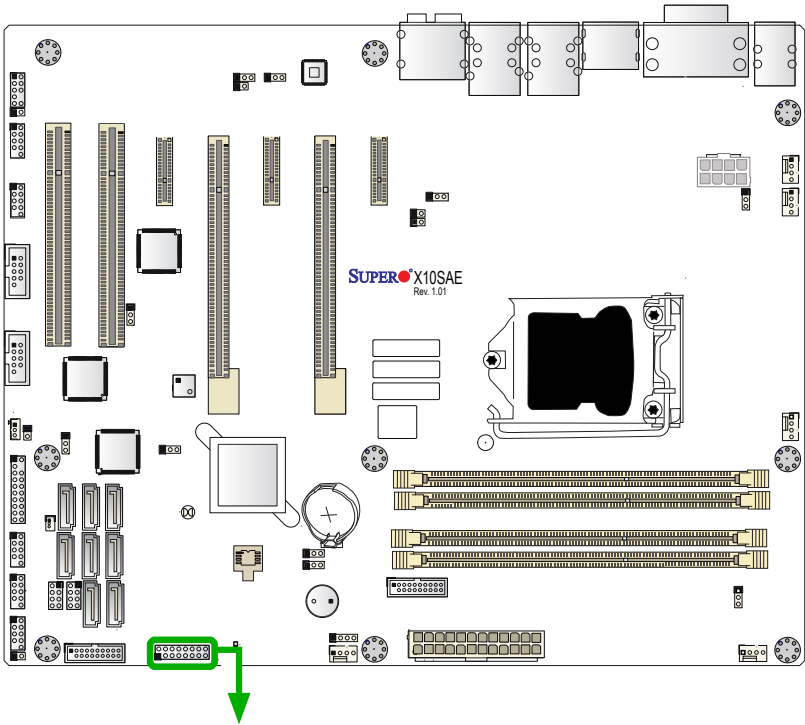

JF1 Header Pins

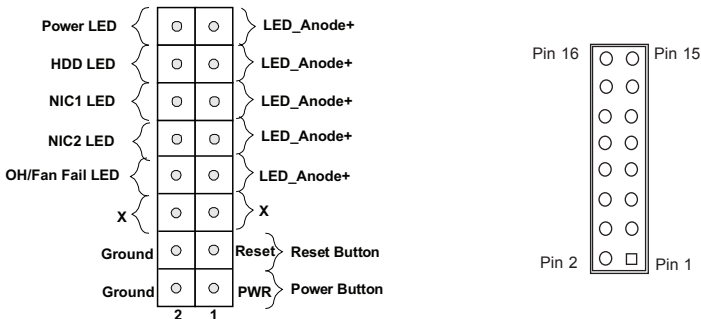

Front Control Panel Pin Definitions

Power LED

The Power LED connection is located on pins 15 and 16 of JF1. Refer to the table on the right for pin definitions.

Power LED Pin Definitions (JF1)	
Pin#	Definition
15	+5V
16	Ground

HDD LED

The HDD LED connection is located on pins 13 and 14 of JF1. Attach a cable here to indicate the status of HDD-related activities, including IDE, SATA activities. See the table on the right for pin definitions.

HDD LED Pin Definitions (JF1)	
Pin#	Definition
13	+5V
14	HD Active

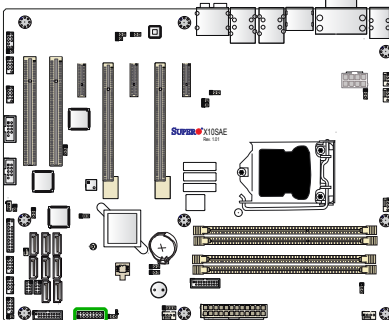

A. PWR LED

B. HDD LED

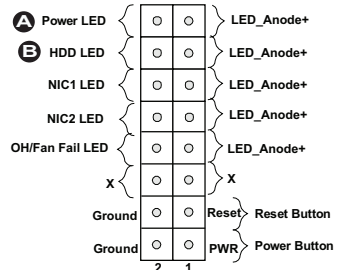

NIC1/NIC2 (LAN1/LAN2)

The NIC (Network Interface Controller) LED connection for LAN port 1 is located on pins 11 and 12 of JF1, and the LED connection for LAN Port 2 is on Pins 9 and 10. NIC1 LED and NIC2 LED are 2-pin NIC LED headers. Attach NIC LED cables to NIC1 and NIC2 LED indicators to display network activities. Refer to the table on the right for pin definitions.

LAN1/LAN2 LED Pin Definitions (JF1)	
Pin#	Definition
9/11	Vcc
10/12	Ground

Overheat (OH)/Fan Fail

Connect an LED cable to OH/Fan Fail connections on pins 7 and 8 of JF1 to provide warnings for chassis overheat/fan failure. Refer to the table on the right for pin definitions.

OH/Fan Fail LED Pin Definitions (JF1)	
Pin#	Definition
7	Vcc/Blue UID LED
8	OH/Fan Fail LED

OH/Fan Fail Indicator Status	
State	Definition
Off	Normal
On	Overheat
Flash- ing	Fan Fail

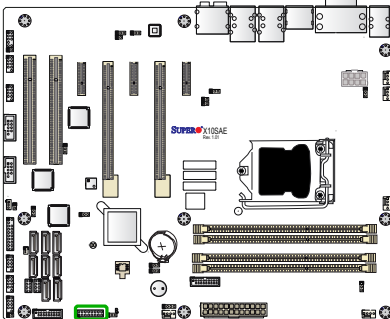

- A. NIC1 LED
- B. NIC2 LED
- C. OH/Fan Fail

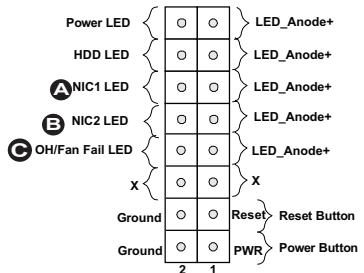

2-7 Connecting Cables

This section provides brief descriptions and pin-out definitions for onboard headers and connectors. Be sure to use the correct cable for each header or connector. For information on Backpanel USB and Front Panel USB ports, refer to Page 2-18. For Front Panel Audio, please refer to Page 2-19.

ATX Main PWR & CPU PWR Connectors (JPW1 & JPW2)

The 24-pin main power connector (JPW1) is used to provide power to the motherboard. The 8-pin CPU PWR connector (JPW2) is also required for the processor. These power connectors meet the SSI EPS 12V specification. See the table on the right for pin definitions.

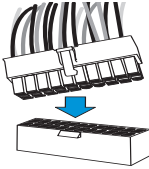

24-Pin Main PWR

ATX Power 24-pin Connector Pin Definitions (JPW1)			
Pin#	Definition	Pin #	Definition
13	+3.3V	1	+3.3V
14	-12V	2	+3.3V
15	COM	3	COM
16	PS_ON	4	+5V
17	COM	5	COM
18	COM	6	+5V
19	COM	7	COM
20	Res (NC)	8	PWR_OK
21	+5V	9	5VSB
22	+5V	10	+12V
23	+5V	11	+12V
24	COM	12	+3.3V

12V 8-pin Power Connector Pin Definitions

Pins	Definition
1 through 4	Ground
5 through 8	+12V

(Required)

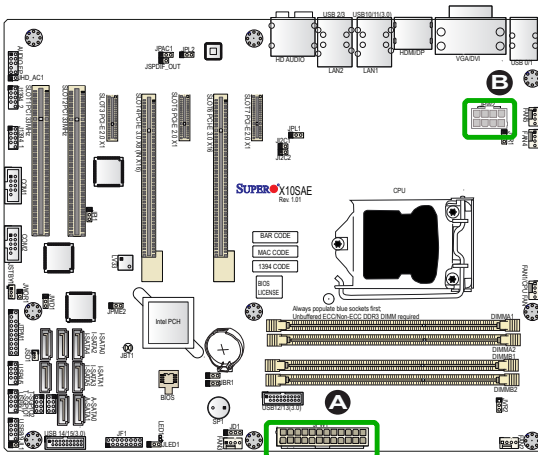

A. 24-Pin ATX Main PWR

B. 8-Pin PWR

Fan Headers (Fan 1 ~ Fan 5)

The X10SAE has five fan headers (Fan 1~Fan 5). These fans are 4-pin fan headers. Although pins 1-3 of the fan headers are backward compatible with the traditional 3-pin fans, we recommend the use 4-pin fans to take advantage of the fan speed control via Pulse Width Modulation through BIOS. This allows the fan speeds to be automatically adjusted based on the motherboard temperature. Refer to the table on the right for pin definitions.

Fan Header Pin Definitions	
Pin#	Definition
1	Ground (Black)
2	2.5A/+12V (Red)
3	Tachometer
4	PWM_Control

Chassis Intrusion Pin Definitions (JL1)	
Pin#	Definition
1	Intrusion Input
2	Ground

Chassis Intrusion (JL1)

A Chassis Intrusion header is located at JL1 on the motherboard. Attach the appropriate cable from the chassis to inform you of a chassis intrusion when the chassis is opened.

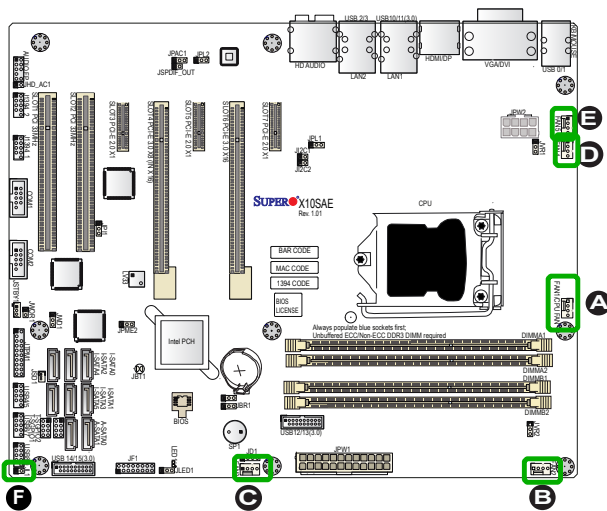

- A. Fan 1 (CPU Fan)
- B. Fan 2
- C. Fan 3
- D. Fan 4
- E. Fan 5
- F. Chassis Intrusion

Internal Buzzer (SP1)

The Internal Buzzer (SP1) can be used to provide audible indications for various beep codes. See the table on the right for pin definitions.

Internal Buzzer Pin Definition		
Pin#	Definitions	
Pin 1	Pos. (+)	Beep In
Pin 2	Neg. (-)	Alarm Speaker

Speaker Connector Pin Definitions	
Pin Setting	Definition
Pins 3~4	Internal Speaker
Pins1~4	External Speaker

Speaker (JD1)

On the JD1 header, pins 3~4 are used for internal speaker. Close pins 3-4 with a cap to use the onboard speaker. If you wish to use an external speaker, close pins 1-4 with a cable. See the table on the right for pin definitions.

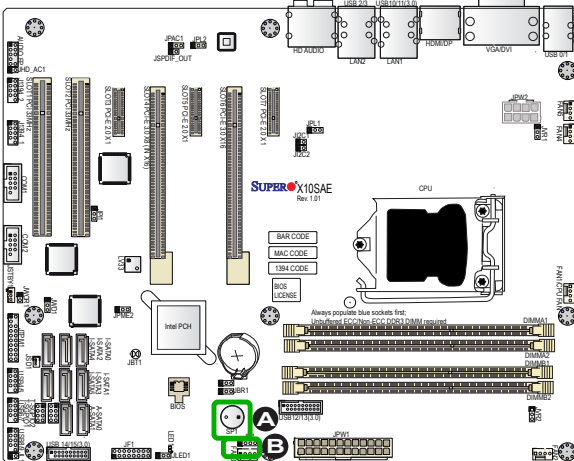

- A. Internal Buzzer
- B. Speaker Header

Onboard Power LED (JLED1)

An onboard Power LED header is located at JLED1. This Power LED header is connected to Front Control Panel located at JF1 to indicate the status of system power. See the table on the right for pin definitions.

Onboard PWR LED Pin Definitions	
Pin#	Definition
1	VCC
2	No Connection
3	Connection to PWR LED in JF1

Serial Ports (COM1/COM2)

There are two serial (COM) port headers on the motherboard. COM1/COM2 are located next to the 1394-1 connection header. See the table on the right for pin definitions.

Serial/COM Ports Pin Definitions			
Pin #	Definition	Pin #	Definition
1	DCD	6	DSR
2	RXD	7	RTS
3	TXD	8	CTS
4	DTR	9	RI
5	Ground	10	N/A

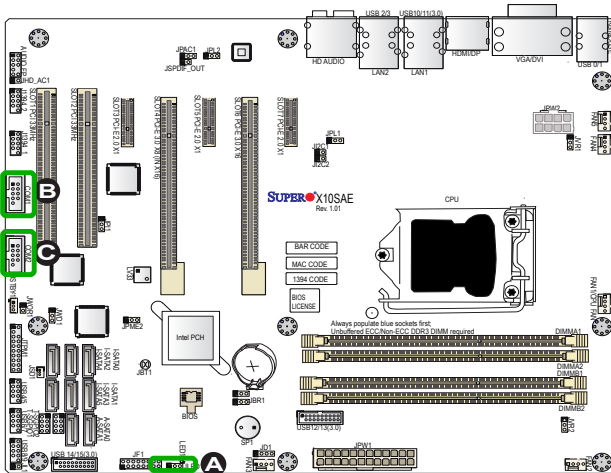

- A. PWR LED
- B. COM1
- C. COM2

DOM PWR Connector (JSD1)

The Disk-On-Module (DOM) power connector, located at JSD1, provides 5V (Gen1/Gen) power to a solid state DOM storage device connected to one of the SATA ports. See the table on the right for pin definitions.

DOM PWR Pin Definitions	
Pin#	Definition
1	5V
2	Ground
3	Ground

Wake-On-Ring (JWOR1)

The Wake-On-Ring header is located at JWOR1. This feature allows your computer to wake up when receiving an incoming call to the modem while in the suspend state. This header is provided to support legacy devices. See the table on the right for pin definitions.

Wake-On-Ring Pin Definitions	
Pin#	Definition
1	Ground
2	Wake-up

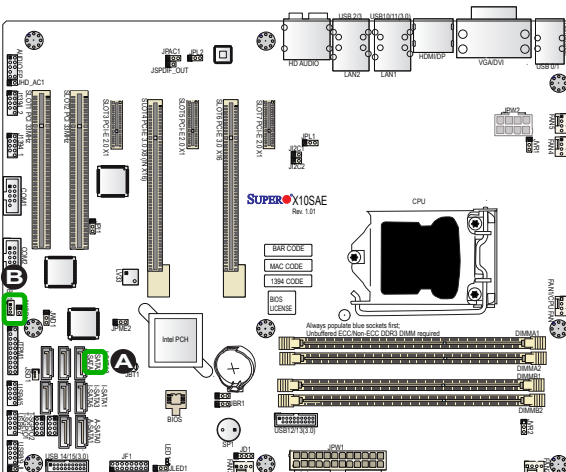

A. DOM PWR

B. JWOR1

SPDIF_Out (JSPDIF_OUT)

The SPDIF Out (JSPDIF_OUT) is used for digital audio. You will also need the appropriate cable to use these features.

SPDIF_Out Pin Definitions	
Pin#	Definition
1	S/SPDIF_Out
2	Ground

T-SGPIO 1/2 Headers

Two Serial-Link General Purpose Input/Output headers (T-SGPIO 1/2) are located on the motherboard to enhance system performance. See the table on the right for pin definitions.

T-SGPIO Pin Definitions			
Pin#	Definition	Pin	Definition
1	NC	2	NC
3	Ground	4	Data
5	Load	6	Ground
7	Clock	8	NC

Note: NC= No Connection

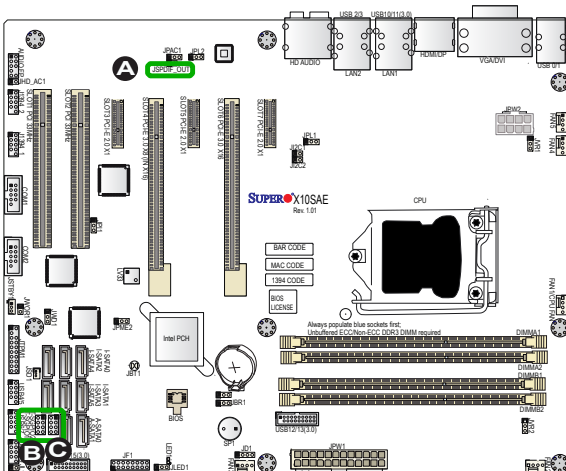

- A. SPDIF_Out
- B. T-SGPIO 1
- C. T-SGPIO 2

TPM Header/Port 80 Header

A Trusted Platform Module/Port 80 header is located at JTPM1 to provide TPM support and Port 80 connection. Use this header to enhance system performance and data security. See the table on the right for pin definitions.

TPM/Port 80 Header Pin Definitions			
Pin #	Definition	Pin #	Definition
1	LCLK	2	GND
3	LFRAME#	4	<(KEY)>
5	LRESET#	6	+5V (X)
7	LAD 3	8	LAD 2
9	+3.3V	10	LAD1
11	LAD0	12	GND
13	SMB_CLK4	14	SMB_DAT4
15	+3V_DUAL	16	SERIRQ
17	GND	18	CLKRUN# (X)
19	LPCPD#	20	LDRQ# (X)

Standby Power Header

The Standby Power header is located at STBY1 on the motherboard. See the table on the right for pin definitions.

Standby Power Pin Definitions	
Pin#	Definition
1	+5V Standby
2	Ground
3	Wake-up

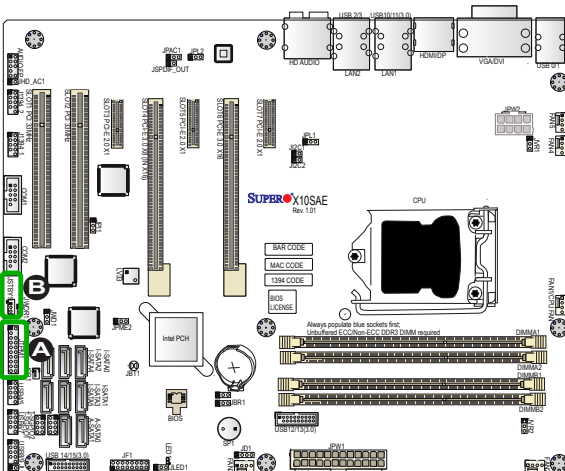

A. TPM/Port 80

B. Standby PWR Header

IEEE 1394_1/1394_2 Connectors

1394_1 and 1394_2 provide IEEE 1394 connections on the motherboard. Connect IEEE 1394 cables to the connectors for IEEE 1394 support. See the tables on the right for pin definitions.

1394_1 Pin Definitions			
Pin#	Definition	Pin#	Definition
1	PTPA0+	2	PTPA0-
3	GND	4	GND
5	PTPB0+	6	PTPB0-
7	PWR 1394a	8	PWR 1394a
		10	Shield GND

1394_2 Pin Definitions			
Pin#	Definition	Pin#	Definition
1	PTPA1+	2	PTPA1-
3	GND	4	GND
5	PTPB1+	6	PTPB1-
7	PWR 1394a	8	PWR 1394a
		10	Shield GND

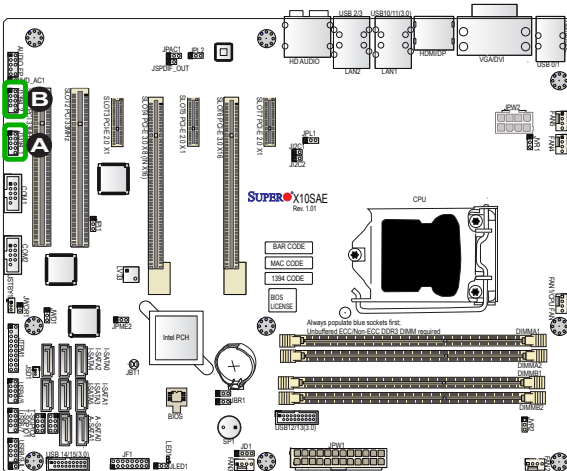

A. 1394_1

B. 1394_2

CMOS Clear (JBT1)

JBT1 is used to clear the saved system setup configuration stored in the CMOS chip. To clear the contents of the CMOS, completely shut down the system, remove the AC power cord and then short JBT1 with a jumper. Remove the jumper before powering on the system again. This will erase all user settings and revert everything to their factory-set defaults.

PCI Slot SMB Enable (J²C1/J²C2)

Use Jumpers J²C1/J²C2 to enable PCI SMB (System Management Bus) support to improve system management for the PCI slots. See the table on the right for jumper settings.

PCI Slot_SMB Enable Jumper Settings	
Jumper Setting	Definition
Short	Enabled
Open (Default)	Disabled

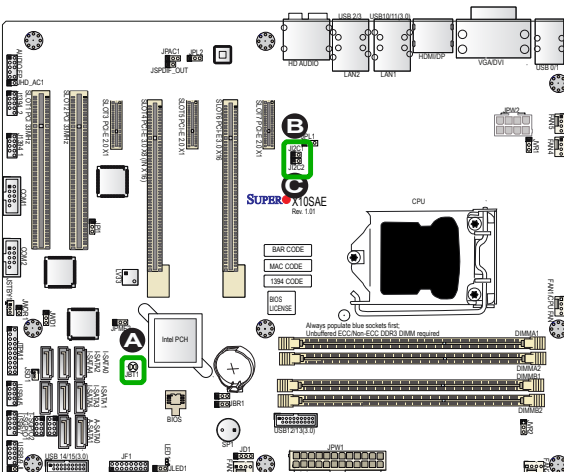

- A. Clear CMOS
- B. J²C1
- C. J²C2

Front Panel Audio Enable (JPAC1)

JPAC1 allows you to enable or disable front panel audio support. The default position is on pins 1 and 2 to enable on-board audio connections. See the table on the right for jumper settings.

Audio Enable/Disable Jumper Settings	
Both Jumpers	Definition
Pins 1-2	Enabled
Pins 2-3	Disabled

HD Audio Enable (JHD_AC1)

Use HD Audio Jumper (JHD_AC1) to enable or disable the High Definition (HD) MultiMedia Audio connector located on the back panel. The default position is on pins 1 and 2 to enable onboard audio connections. See the table on the right for jumper settings.

HD Audio Enable/Disable Jumper Settings	
Both Jumpers	Definition
Pins 1-2	Enabled
Pins 2-3	Disabled

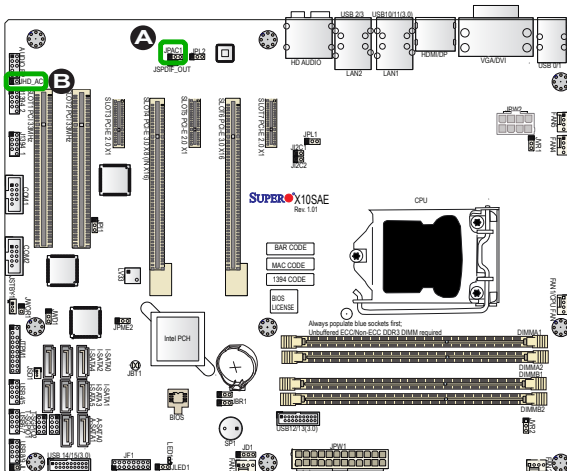

A. (FP) Audio Enable

B. HD Audio Enable

Manufacturer Mode Select

Close pins 2 and 3 of Jumper JPME2 to bypass SPI flash security and force the system to operate in the Manufacturer mode, allowing the user to flash the system firmware from a host server for system setting modifications. See the table on the right for jumper settings.

ME Mode Select Jumper Settings	
Jumper Setting	Definition
1-2	Normal (Default)
2-3	Manufacture Mode

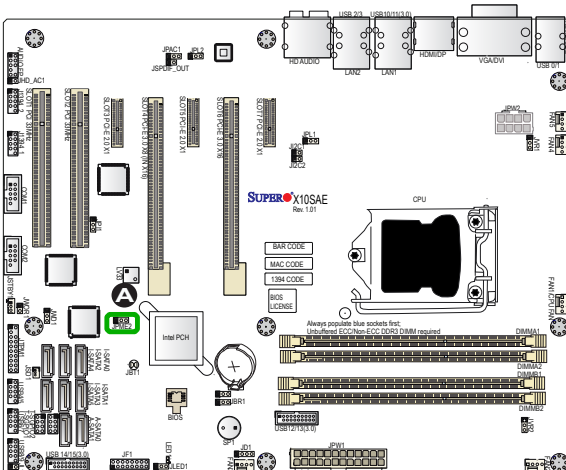

A. JPME2

Watch Dog Enable/Disable

Watch Dog (JWD1) is a system monitor that can reboot the system when a software application hangs. Close pins 1-2 to reset the system if an application hangs. Close pins 2-3 to generate a non-maskable interrupt signal for the application that hangs. See the table on the right for jumper settings. Watch Dog must also be enabled in the BIOS.

Watch Dog Jumper Settings	
Jumper Setting	Definition
Pins 1-2	Reset (default)
Pins 2-3	NMI
Open	Disabled

BIOS Recovery Enable (JBR1)

Close pins 2 and 3 of jumper JBR1 for BIOS recovery. The default setting is on pins 1 and 2 for normal operation. Refer to page D-2 for more details on BIOS recovery. See the table on the right for jumper settings.

BIOS Recovery Jumper Settings	
Both Jumpers	Definition
Pins 1-2	Normal (Default)
Pins 2-3	BIOS Recovery Enable

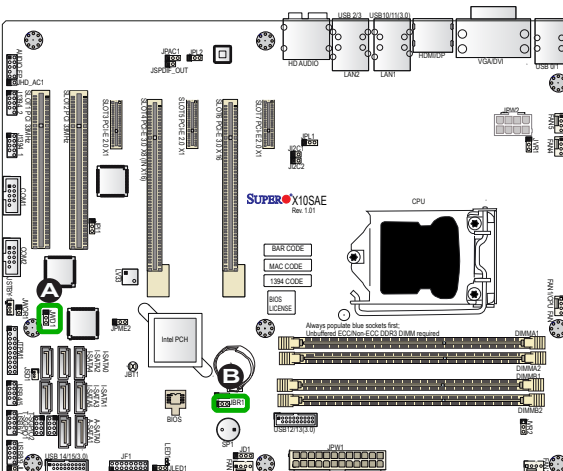

A. JWD1

B. JBR1

2-9 Onboard Indicators

LAN 1/LAN 2 LEDs

Two LAN ports (LAN 1/LAN 2) are located on the I/O backplane of the motherboard. Each Ethernet LAN port has two LEDs. The yellow LED indicates activity, while the Link LED may be green, amber, or off to indicate the speed of the connections. See the tables at right for more information.

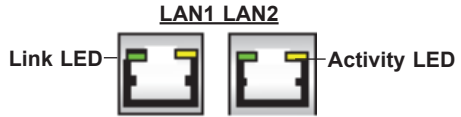

GLAN 1/2 Activity Indicator LED Settings		
Color	Status	Definition
Yellow	Flashing	Active

GLAN Ports 1/2 Link Indicator LED Settings	
LED Color	Definition
Off	No Connection/10 Mbps
Green	100 Mbps
Amber	1 Gbps

Onboard Power LED (LED1)

An Onboard Power LED is located at LED1 on the motherboard. When LED1 is on, the AC power cable is connected. Make sure to disconnect the power cable before removing or installing any component. See the layout below for the LED location.

Onboard PWR LED Indicator LED Status	
Status	Definition
Off	System Off
On	System on, or System off and PWR Cable Connected

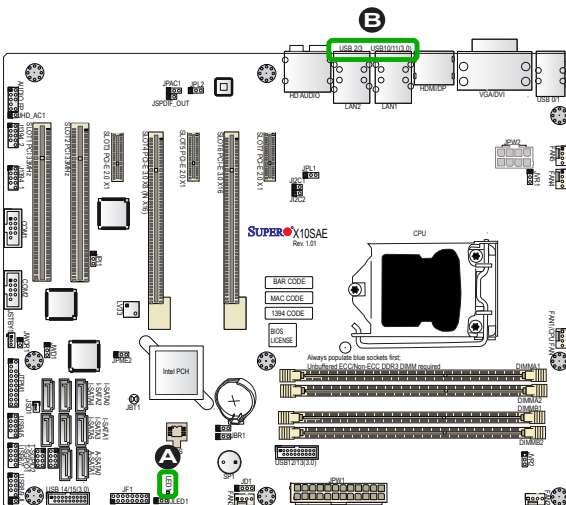

A. LAN 1/2 LEDs

B. PWR LED



2-10 SATA Connections

SATA Connections (I-SATA0-I-SATA5)

Eight Serial ATA (SATA) 3.0 (6Gb/s) connectors are located on the motherboard. I-SATA 0-5 (RAID 0, 1, 5, 10) are supported by the Intel C226 PCH chip. A-SATA 0/1 are supported by ASM1061R SATA Controller. These Serial Link connections provide faster data transmission than legacy Parallel ATA. See the table on the right for pin definitions.

SATA 3.0 Connectors Pin Definitions	
Pin#	Signal
1	Ground
2	SATA_TXP
3	SATA_TXN
4	Ground
5	SATA_RXN
6	SATA_RXP
7	Ground

- A. I-SATA 3.0 #0
- B. I-SATA 3.0 #1
- C. I-SATA 3.0 #2
- D. I-SATA 3.0 #3
- E. I-SATA 3.0 #4
- F. I-SATA 3.0 #5
- G. A-SATA 3.0 #0
- H. A-SATA 3.0 #1

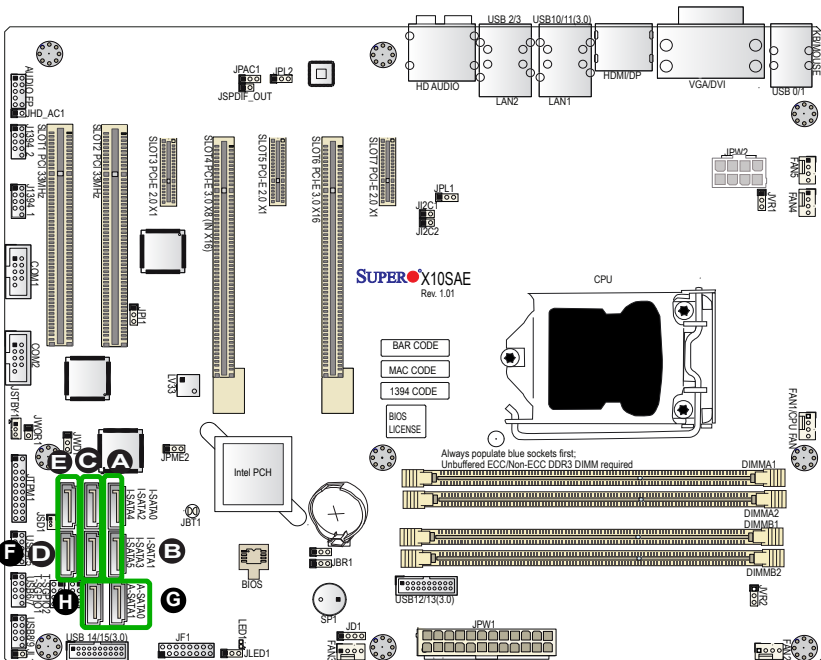

Notes

Chapter 3

Troubleshooting

3-1 Troubleshooting Procedures

Use the following procedures to troubleshoot your system. If you have followed all of the procedures below and still need assistance, refer to the 'Technical Support Procedures' and/or 'Returning Merchandise for Service' section(s) in this chapter. Always disconnect the AC power cord before adding, changing or installing any hardware components.

Before Power On

1. Make sure that the Standby PWR LED is not on. (**Note:** If it is on, the onboard power is on. Be sure to unplug the power cable before installing or removing the components.)
2. Make sure that there are no short circuits between the motherboard and chassis.
3. Disconnect all ribbon/wire cables from the motherboard, including those for the keyboard and mouse. Also, be sure to remove all add-on cards.
4. Install a CPU and heatsink (-be sure that it is fully seated) and then connect the chassis speaker and the power LED to the motherboard. Check all jumper settings as well.

No Power

1. Make sure that there are no short circuits between the motherboard and chassis.
2. Make sure that all jumpers are set to their default positions.
3. Check if the 115V/230V switch on the power supply is properly set.
4. Turn the power switch on and off to test the system.
5. The battery on your motherboard may be old. Check to make sure that it still supplies ~3VDC. If it does not, replace it with a new one.

No Video

1. If the power is on, but you have no video--in this case, you will need to remove all the add-on cards and cables first.
2. Use the speaker to determine if any beep codes exist. (Refer to Appendix A for details on beep codes.)
3. Remove all memory modules and turn on the system. (If the alarm is on, check the specifications of memory modules, reset the memory or try a different one.)

Memory Errors

1. Make sure that the DIMM modules are properly installed and fully seated in the slots.
2. You should be using unbuffered ECC/Non-ECC DDR3 (1.5V) 1600/1333/1066 MHz memory recommended by the manufacturer. Also, it is recommended that you use the memory modules of the same type and speed for all DIMMs in the system. Do not use memory modules of different sizes, different speeds and different types on the same motherboard.
3. Check for bad DIMM modules or slots by swapping modules between slots to see if you can locate the faulty ones.
4. Check the switch of 115V/230V power supply.

Losing the System's Setup Configuration

1. Please be sure to use a high quality power supply. A poor quality power supply may cause the system to lose CMOS setup information. Refer to Section 1-6 for details on recommended power supplies.
2. The battery on your motherboard may be old. Check to verify that it still supplies ~3VDC. If it does not, replace it with a new one.
3. If the above steps do not fix the Setup Configuration problem, contact your vendor for repairs.

3-2 Technical Support Procedures

Before contacting Technical Support, please make sure that you have followed all the steps listed below. Also, Note that as a motherboard manufacturer, Supermicro does not sell directly to end users, so it is best to first check with your distributor or reseller for troubleshooting services. They should know of any possible problem(s) with the specific system configuration that was sold to you.

1. Please go through the 'Troubleshooting Procedures' and 'Frequently Asked Question' (FAQ) sections in this chapter or see the FAQs on our website (<http://www.supermicro.com/support/faqs/>) before contacting Technical Support.
2. BIOS upgrades can be downloaded from our website at (<http://www.supermicro.com/support/bios/>).



Note: Not all BIOS can be flashed. Some cannot be flashed; it depends on the boot block code of the BIOS.

3. If you've followed the instructions above to troubleshoot your system, and still cannot resolve the problem, then contact Supermicro's technical support and provide them with the following information:
 - Motherboard model and PCB revision number
 - BIOS release date/version (this can be seen on the initial display when your system first boots up)
 - System configuration
 - An example of a Technical Support form is on our website at (<http://www.supermicro.com/support/contact.cfm>).
4. Distributors: For immediate assistance, please have your account number ready when placing a call to our technical support department. We can be reached by e-mail at support@supermicro.com, by phone at: (408) 503-8000, option 2, or by fax at (408)503-8019.

3-3 Frequently Asked Questions

Question: What type of memory does my motherboard support?

Answer: The X10SAE supports up to 32GB of unbuffered ECC/Non-ECC DDR3 SDRAM (1.5V, 1600/1333/1066 MHz). See Section 2-4 for details on installing memory.

Question: How do I update my BIOS?

Answer: We do NOT recommend that you upgrade your BIOS if you are not experiencing any problems with your system. Updated BIOS files are located on our website at <http://www.supermicro.com/support/bios/>. Please check our BIOS warning message and the information on how to update your BIOS on our web site. Select your motherboard model and download the BIOS ROM file to your computer. Also, check the current BIOS revision to make sure that it is newer than your BIOS before downloading. You may choose the zip file or the .exe file. If you choose the zipped BIOS file, please unzip the BIOS file onto a bootable device or a USB pen/thumb drive. To flash the BIOS, run the batch file named "ami.bat" with the new BIOS ROM file from your bootable device or USB pen/thumb drive. Use the following format:

```
F:\> ami.bat BIOS-ROM-filename.xxx <Enter>
```



Note: Always use the file named "ami.bat" to update the BIOS, and insert a space between "ami.bat" and the filename. The BIOS-ROM-filename will bear the motherboard name (i.e., X10SAE) and build version as the extension. For example, "X10SAE.115". When completed, your system will automatically reboot.

If you choose the .exe file, please run the .exe file under Windows to create the BIOS flash floppy disk. Insert the floppy disk into the system you wish to flash the BIOS. Then, boot the system to the floppy disk. The BIOS utility will automatically flash the BIOS without any prompts. Please note that this process may take a few minutes to complete. Do not be concerned if the screen is paused for a few minutes.

When the BIOS flashing screen is completed, the system will reboot and will show "Press F1 or F2". At this point, you will need to load the BIOS defaults. Press <F1> to go to the BIOS setup screen, and press <F9> to load the default settings. Next, press <F10> to save and exit. The system will then reboot.

Warning: Do not shut down or reset the system while updating the BIOS to prevent possible system boot failure!



Important: The SPI BIOS chip installed on this motherboard is not removable. To repair or replace a damaged BIOS chip, please send your motherboard to RMA at Supermicro for service.

Question: I think my BIOS is corrupted. How can I recover my BIOS?

Answer: Please see Appendix C-BIOS Recovery for detailed instructions.

Question: What is the heatsink part number for my X10SAE motherboard?

Answer: For the 1U passive heatsink, ask for SNK-P0046P (back plate is included). For the 2U active heatsink, use SNK-P0046A4.

Question: Why can't I recover the BIOS even when I've followed the instructions in the user's manual for the motherboard?

Answer: Please disable the IPMI jumper and try it again. For the jumper location, please check Chapter 1.

3-4 Battery Removal and Installation

Battery Removal

To remove the onboard battery, follow the steps below:

1. Power off your system and unplug your power cable.
2. Locate the onboard battery as shown below.
3. Using a tool such as a pen or a small screwdriver, push the battery lock outwards to unlock it. Once unlocked, the battery will pop out from the holder.
4. Remove the battery.

Proper Battery Disposal

Warning: Please handle used batteries carefully. Do not damage the battery in any way; a damaged battery may release hazardous materials into the environment. Do not discard a used battery in the garbage or a public landfill. Please comply with the regulations set up by your local hazardous waste management agency to dispose of your used battery properly.

Battery Installation

1. To install an onboard battery, follow the steps 1 & 2 above and continue below:
2. Identify the battery's polarity. The positive (+) side should be facing up.
3. Insert the battery into the battery holder and push it down until you hear a click to ensure that the battery is securely locked.

Warning: When replacing a battery, be sure to only replace it with the same type.

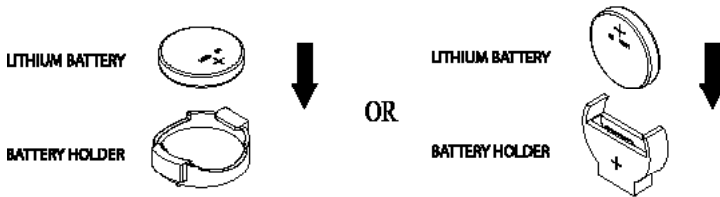

3-5 Returning Merchandise for Service

A receipt or copy of your invoice marked with the date of purchase is required before any warranty service will be rendered. You can obtain service by calling your vendor for a Returned Merchandise Authorization (RMA) number. For faster service, you may also obtain RMA authorizations online (<http://www.supermicro.com/support/rma/>). When you return the motherboard to the manufacturer, the RMA number should be prominently displayed on the outside of the shipping carton, and mailed prepaid or hand-carried. Shipping and handling charges will be applied for all orders that must be mailed when service is complete.

This warranty only covers normal consumer use and does not cover damages incurred in shipping or from failure due to the alteration, misuse, abuse or improper maintenance of products.

During the warranty period, contact your distributor first for any product problems.

Chapter 4

BIOS

4-1 Introduction

This chapter describes the AMI BIOS Setup Utility for the X10SAE. The ROM BIOS is stored in a Flash EEPROM and can be easily updated. This chapter describes the basic navigation of the AMI BIOS Setup Utility setup screens.



Note: For AMI BIOS Recovery, please refer to the UEFI BIOS Recovery Instructions in Appendix C.

Starting BIOS Setup Utility

To enter the AMI BIOS Setup Utility screens, press the <Delete> key while the system is booting up.



Note: In most cases, the <Delete> key is used to invoke the AMI BIOS setup screen. There are a few cases when other keys are used, such as <F1>, <F2>, etc.

Each main BIOS menu option is described in this manual. The Main BIOS setup menu screen has two main frames. The left frame displays all the options that can be configured. Grayed-out options cannot be configured. Options in blue can be configured by the user. The right frame displays the key legend. Above the key legend is an area reserved for a text message. When an option is selected in the left frame, it is highlighted in white. Often a text message will accompany it. (**Note:** the AMI BIOS has default text messages built in. Supermicro retains the option to include, omit, or change any of these text messages.)

The AMI BIOS Setup Utility uses a key-based navigation system called "hot keys". Most of the AMI BIOS setup utility "hot keys" can be used at any time during the setup navigation process. These keys include <F1>, <F4>, <Enter>, <ESC>, arrow keys, etc.



Note: Options printed in **Bold** are default settings.

How To Change the Configuration Data

The configuration data that determines the system parameters may be changed by entering the AMI BIOS Setup utility. This Setup utility can be accessed by pressing at the appropriate time during system boot.

How to Start the Setup Utility

Normally, the only visible Power-On Self-Test (POST) routine is the memory test. As the memory is being tested, press the <Delete> key to enter the main menu of the AMI BIOS Setup Utility. From the main menu, you can access the other setup screens. An AMI BIOS identification string is displayed at the left bottom corner of the screen, below the copyright message.

Warning: Do not upgrade the BIOS unless your system has a BIOS-related issue. Flashing the wrong BIOS can cause irreparable damage to the system. In no event shall Supermicro be liable for direct, indirect, special, incidental, or consequential damages arising from a BIOS update. If you have to update the BIOS, do not shut down or reset the system while the BIOS is updating. This is to avoid possible boot failure.

4-2 Main Setup

When you first enter the AMI BIOS Setup utility, you will enter the Main setup screen. You can always return to the Main setup screen by selecting the Main tab on the top of the screen. The Main BIOS Setup screen is shown below.

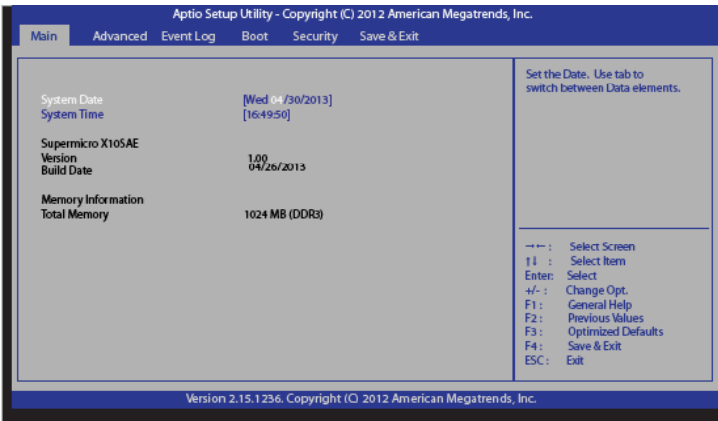

The following Main menu items will display:

System Time/System Date

Use this option to change the system date and time. Highlight *System Date* or *System Time* using the arrow keys. Enter new values through the keyboard. Press the <Tab> key or the arrow keys to move between fields. The date must be entered in Day MM/DD/YY format. The time is entered in HH:MM:SS format.



Note: The time is in the 24-hour format. For example, 5:30 P.M. appears as 17:30:00.

The following BIOS items will also be displayed:

Supermicro X10SAE

Version

Build Date

Memory Information

Total Memory

This displays the total size of memory available in the system.

4-3 Advanced Setup Configurations

Use the arrow keys to select Boot Setup and press <Enter> to access the submenu items:

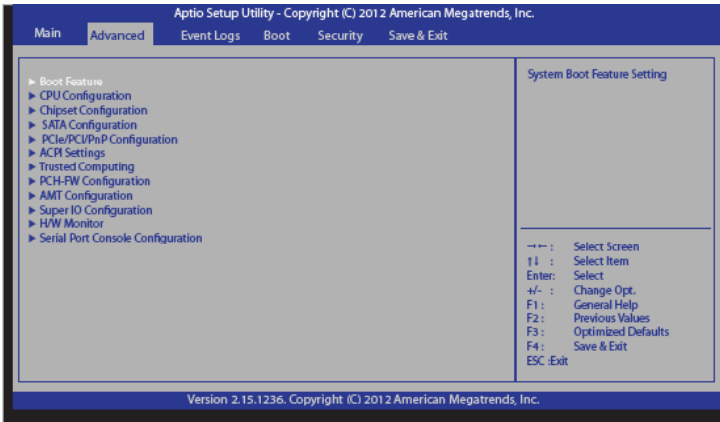

Warning: Take Caution when changing the Advanced settings. An incorrect value, a very high DRAM frequency, or an incorrect DRAM timing setting may make the system unstable. When this occurs, revert to the setting to its manufacture default setting.

►Boot Feature

Quiet Boot

This feature selects the screen display between POST messages or the OEM logo at bootup. Select Disabled to display the POST messages. Select Enabled to display the OEM logo instead of the normal POST messages. The options are **Enabled** and Disabled.

AddOn ROM Display Mode

This feature sets the display mode for the Option ROM. Select Keep Current to use the current AddOn ROM display setting. Select Force BIOS to use the Option ROM display mode set by the system BIOS. The options are **Force BIOS** and Keep Current.

Bootup Num-Lock

This feature selects the Power-on state for the Numlock key. The options are Off and **On**.

Wait For 'F1' If Error

This feature forces the system to wait until the 'F1' key is pressed if an error occurs. The options are Disabled and **Enabled**.

Interrupt 19 Capture

Interrupt 19 is the software interrupt that handles the boot disk function. When this item is set to Enabled, the ROM BIOS of the host adaptors will "capture" Interrupt 19 at bootup and allow the drives that are attached to these host adaptors to function as bootable disks. If this item is set to Disabled, the ROM BIOS of the host adaptors will not capture Interrupt 19, and the drives attached to these adaptors will not function as bootable devices. The options are **Enabled** and Disabled.

Re-try Boot

If this item is enabled, the BIOS will automatically reboot the system from a specified boot device after its initial boot failure. The options are **Disabled**, Legacy Boot, and EFI Boot.

►Power Configuration**Watch Dog Function**

If enabled, the Watch Dog Timer will allow the system to reboot when it is inactive for more than 5 minutes. The options are Enabled and **Disabled**.

Power Button Function

This feature controls how the system shuts down when the power button is pressed. Select 4_Seconds_Override for the user to power off the system after pressing and holding the power button for 4 seconds or longer. Select Instant Off to instantly power off the system as soon as the user presses the power button. The options are 4 Seconds Override and **Instant Off**.

Restore on AC Power Loss

Use this feature to set the power state after a power outage. Select Power-Off for the system power to remain off after a power loss. Select Power-On for the system power to be turned on after a power loss. Select Last State to allow the system to resume its last power state before a power loss. The options are Power-On, Stay-Off and **Last State**.

►CPU Configuration

The following CPU information will be displayed:

- Type of CPU
- CPU Signature
- Microcode Patch
- Max (Maximum) CPU Speed
- Min (Minimum) CPU Speed
- CPU Speed
- Processor Cores
- Intel HT(Hyper-Threading) Technology
- Intel VT-x (Virtualization) Technology
- Intel SMX (Trusted Execution) Technology
- 64-bit
- EIST Technology
- CPU C3 State
- CPU C6 State
- CPU C7 State
- L1 Data Cache
- L1 Code Cache
- L2 Cache
- L3 Cache

Clock Spread Spectrum

If this feature is set to Enabled, the BIOS will monitor the level of Electromagnetic Interference caused by the components and will attempt to reduce the interference whenever needed. The options are Enabled and **Disabled**.

Hyper-threading

Select Enabled to support Intel Hyper-threading Technology to enhance CPU performance. The options are **Enabled** and Disabled.

Active Processor Cores

This feature determines how many CPU cores will be activated for each CPU. When all is selected, all cores in the CPU will be activated. (Please refer to Intel's web site for more information.) The options are **All**, 1, 2, and 3.

Limit CPUID Maximum

Select Enabled to set the maximum CPU ID value and to boot the legacy operating systems that cannot support processors with extended CPUID functions. The options are Enabled and **Disabled** (for the Windows OS).

Execute-Disable Bit Capability (Available if supported by the OS & the CPU)

Set to Enabled to enable the Execute Disable Bit which will allow the processor to designate areas in the system memory where an application code can execute and where it cannot, thus preventing a worm or a virus from flooding illegal codes to overwhelm the processor or damage the system during an attack. The default is **Enabled**. (Refer to Intel and Microsoft Web Sites for more information.)

Intel® Virtualization Technology (Available when supported by the CPU)

Select Enabled to use the Intel Virtualization Technology to allow one platform to run multiple operating systems and applications in independent partitions, creating multiple "virtual" systems in one physical computer. The options are **Enabled** and Disabled.

Hardware Prefetcher (Available when supported by the CPU)

If set to Enabled, the hardware prefetcher will prefetch streams of data and instructions from the main memory to the L2 cache to improve CPU performance. The options are Disabled and **Enabled**.

Adjacent Cache Line Prefetch (Available when supported by the CPU)

Select Enabled for the CPU to prefetch both cache lines for 128 bytes as comprised. Select Disabled for the CPU to prefetch both cache lines for 64 bytes. The options are Disabled and **Enabled**.



Note: If there is any change to this setting, you will need to reboot the system for the change to take effect. Please refer to Intel's web site for detailed information.

CPU AES

Select Enable to enable Intel CPU Advanced Encryption Standard (AES) Instructions for CPU to enhance data integrity. The options are **Enabled** and Disabled.

EIST

EIST (Enhanced Intel SpeedStep Technology) allows the system to automatically adjust processor voltage and core frequency in an effort to reduce power consumption and heat dissipation. **Please refer to Intel's web site for detailed information.** The options are Disabled and **Enabled**.

Turbo Mode

This feature allows processor cores to run faster than the frequency recommended by the manufacturer. The options are Disabled and **Enabled**. If this feature is set to Enabled, the following items will display:

CPU Power Limit1 (Available when "Turbo Mode" is set to Enabled)

Use this feature to set the power limit for CPU1. Use the number keys on your keyboard to enter the value. Enter 0 to use the manufacture default setting.

CPU Power Limit1 Time (Available when "Turbo Mode" is set to Enabled)

This item allows the user to determine how long CPU1 should operate at the power limit set by the user for the item above. Use the number keys on your keyboard to enter the value. Enter 0 to use the manufacture default setting.

CPU Power Limit2 (Available when "Turbo Mode" is set to Enabled)

Use this feature to set the power limit for CPU2. Use the number keys on your keyboard to enter the value. Enter 0 to use the manufacture default setting.

DDR Power Limit1 (Available when "Turbo Mode" is set to Enabled)

Use this feature to set the power limit for DDR1. Use the number keys on your keyboard to enter the value. Enter 0 to use the manufacture default setting.

DDR Power Limit1 Time (Available when "Turbo Mode" is set to Enabled)

This item allows the user to determine how long DDR1 should operate at the power limit set by the item above. Use the number keys on your keyboard to enter the value. Enter 0 to use the manufacture default setting.

DDR Power Limit2 (Available when "Turbo Mode" is set to Enabled)

Use this feature to set the power limit for DDR2. Use the number keys on your keyboard to enter the value. Enter 0 to use the manufacture default setting.

1-Core Ratio Limit (Available when "Turbo Mode" is set to Enabled)

This increases (multiplies) 1 clock speed in the CPU core in relation to the bus speed when one CPU core is active. Press "+" or "-" on your keyboard to change the value. Enter 0 to use the manufacture default setting.

2-Core Ratio Limit (Available when "Turbo Mode" is set to Enabled)

This increases (multiplies) 2 clock speeds in the CPU core in relation to the bus speed when two CPU cores are active. Press "+" or "-" on your keyboard to change the value. Enter 0 to use the manufacture default setting.

3-Core Ratio Limit (Available when "Turbo Mode" is set to Enabled)

This increases (multiplies) 3 clock speeds in the CPU core in relation to the bus speed when three CPU cores are active. Press "+" or "-" on your keyboard to change the value. Enter 0 to use the manufacture default setting.

4-Core Ratio Limit (Available when "Turbo Mode" is set to Enabled)

This increases (multiplies) 4 clock speeds in the CPU core in relation to the bus speed when four CPU cores are active. Press "+" or "-" on your keyboard to change the value. Enter 0 to use the manufacture default setting.

Energy Performance

Use this feature to select an appropriate fan setting to achieve the maximum system performance (with maximum cooling) or maximum energy efficiency (with maximum power saving). The fan speeds are controlled by the firmware management via IPMI 2.0. The options are Performance, **Balanced Performance**, Balanced Energy, and Energy Efficient.

VR Current Value

Use this feature to set the limit on the current voltage regulator (VR). Press "+" or "-" on your keyboard to change this value. Enter 0 to use the manufacture default setting.

CPU C-States

C-States architecture, a processor power management platform developed by Intel, can further reduce power consumption from the basic C1 (Halt State) state that blocks clock cycles to the CPU. Select Enabled for CPU C-Sates support. The options are **Enabled** and Disabled. If this feature is set to Enabled, the following items will display:

Enhanced C1E State (Available when "CPU C-States" is set to Enabled)

Select Enabled to enable Enhanced C1 Power State to boost system performance. The options are **Enabled** and Disabled.

CPU C3 Report (Available when "CPU C-States" is set to Enabled)

Select Enabled to allow the BIOS to report the CPU C3 State (ACPI C2) to the operating system. During the CPU C3 State, the CPU clock generator is turned off. The options are Enabled and **Disabled**.

CPU C6 Report (Available when "CPU C-States" is set to Enabled)

Select Enabled to allow the BIOS to report the CPU C6 State (ACPI C3) to the operating system. During the CPU C6 State, the power to all caches is turned off. The options are **Enabled** and Disabled.

C6 Latency (Available when "CPU C-States" is set to Enabled)

Select Short to set a short delay time(period) during which the BIOS reports CPU C6 State (ACPI C3) to the operating system. Select Long to set a long delay time(period) during which the BIOS reports CPU C6 State (ACPI C3) to the operating system. The options are **Short** and Long.

CPU C7 Report (Available when "CPU C-States" is set to Enabled)

Select Enabled to allow the BIOS to report the CPU C7 State (ACPI C3) to the operating system. CPU C7 State is a processor-specific low C-State. The options are Disabled, CPU C7, and **CPU C7s**

C7 Latency (Available when "CPU C-States" is set to Enabled)

Select Short to set a short delay time(period) during which the BIOS reports CPU C7 State (ACPI C3) to the operating system. Select Long to set a long delay time(period) during which the BIOS reports CPU C7 State (ACPI C3) to the operating system. The options are Short and **Long**.

C1 State Auto Demotion

When this item is enabled, the CPU will conditionally demote C3, C6 or C7 requests to C1 State based on un-cored auto-demote information. The options are Disabled and **Enabled**.

C3 State Auto Demotion

When this item is enabled, the CPU will conditionally demote C6 or C7 requests to C3 State based on un-cored auto-demote information. The options are Disabled and **Enabled**.

C-State Pre-Wake

Select Enabled to support C State Pre-Wake State features. The options are **Enabled** and Disabled

Package C-State limit

Select Auto for the AMI BIOS to automatically set the limit on the C-State package register. The options are C0/C1, C2, C3, C6, C7 and **Auto**.

LakeTiny Feature

Select Enabled for LakeTiny feature support for C-State configuration. The options are Enabled and Disabled.

►Chipset Configuration

Warning! Setting the wrong values in the following sections may cause the system to malfunction.

►System Agent (SA) Configuration

The following System Agent (SA) information will be displayed:

- System Agent Bridge Name
- VT-d Capability

VT-d

Select Enabled to enable Intel Virtualization Technology support for Direct I/O VT-d by reporting the I/O device assignments to VMM through the DMAR ACPI Tables. This feature offers fully-protected I/O resource-sharing across the Intel platforms, providing the user with greater reliability, security and availability in networking and data-sharing. The settings are **Enabled** and Disabled.

►Graphics Configuration

This item displays the following graphics information:

- IGFX VBIOS Version
- IGfx Frequency

Graphics Turbo IMON Current

Use this feature to set the limit on the current voltage regulator. Press "+" or "-" on your keyboard to change this value. The default setting is **31**.

Primary Display

Use this feature to select the graphics device to be used as the primary display. You can select from a device installed on the CPU IGFX, CPU SLOT, or PCH SLOT. The options are **Auto**, CPU IGFX, CPU SLOT, and PCH SLOT.

CPU SLOT (Available when Primary Display is set to Auto)

Use this item to select the graphics device installed in an expansion slot supported by the CPU to be used as the primary display. The options are **Auto**, SLOT6 and SLOT4.

PCH SLOT (Available when Primary Display is set to Auto)

Use this item to select the graphics device installed in an expansion slot supported by the PCH to be used as the primary display. The options are **Auto**, SLOT5, SLOT7, and SLOT1/2.

CPU IGFX

Select Auto to keep an internal graphics device installed on an expansion slot supported by the CPU to be automatically enabled. The options are **Auto**, Disabled, and Enabled.

GTT Size

Use this feature to set the memory size to be used by the graphics translation table (GTT). The options are 1MB and **2MB**.

Aperture Size

Use this feature to set the Aperture size, which is the size of system memory reserved by the BIOS for graphics device use. The options are 128MB, **256MB** and 512 MB.

DVMT Pre-Allocated

Dynamic Video Memory Technology (DVMT) allows dynamic allocation of system memory to be used for video devices to ensure best use of available system memory based on the DVMT 5.0 platform. The options are **32M**, 64M, 96M, 128M, 160M, 192M, 224M, 256M, 288M, 320M, 352M, 384M, 416M, 448M, 480M, 512M, and 1024M.

DVMT (Dynamic Video Memory Technology) Total Gfx Mem

Use this feature to set the total memory size to be used by internal graphics devices based on the DVMT 5.0 platform. The options are 128MB, **256MB** and MAX.

Gfx (Graphics) Low Power Mode

Select Enabled to use the low power mode for internal graphics devices installed in a small form factor (SFF) computer. The options are **Enabled** and Disabled.

►PCI-E Configuration

This item displays the information of the (graphics) device installed on a PCI-E slot.

SLOT6 PCI-E 3.0 x16

SLOT6 PCI-E 3.0 x16 Gen X

This feature allows the user to select PCI-E support for the device installed on SLOT6. The options are **Auto**, Gen1 (Generation 1), Gen 2 and Gen 3.

SLOT4 PCI-E 3.0 x 8 (in x16)

SLOT4 PCI-E 3.0 x 8 (in x16) Gen X

This feature allows the user to select PCI-E support for the device installed on SLOT4. The options are **Auto**, Gen1 (Generation 1), Gen 2 and Gen 3.

Detect Non-Compliance Device

Select Enabled for the AMI BIOS to automatically detect a PCI-E device that is not compliant with the PCI-E standards. The options are Enabled and **Disabled**.

Program PCI-E ASPM After OpROM

PCI-E ASPM, the Active State Power Management for PCI-Express slots, is a power management protocol used to manage power consumption of serial-link devices installed on PCI-Exp slots during a prolonged off-peak time. If this item is set to Enabled, PCI-E ASPM will be programmed after OpROM. If this item is set to Disabled, the PCI-E ASPM will be programmed before OpROM. The options are **Enabled** and Disabled.

SLOT6 PCI-E 3.0 x 16-ASPM/SLOT4 PCI-E 3.0 x8 (in x16)-ASPM

Use this feature to set the ASPM (Active State Power Management) level for the graphics device installed on a PCI-E slot specified by the user. The options are Disabled, **Auto**, ASPM L0s, ASPM L1, and, ASPM L0sL1.

DMI Link ASPM Control

Use this feature to set the ASPM (Active State Power Management) state on the SA (System Agent) side of the DMI Link. The options are Disabled, L0s, L1 and **L0sL1**.

PCH DMI Link ASPM Control

Use this feature to set the ASPM (Active State Power Management) state on the device installed on the DMI Link supported by the PCH chip. The options are Disabled and **Enabled**.

SLOT3 PCI-E 2.0 x 1 ASPM/SLOT5 PCI-E 2.0 x 1 ASPM/SLOT7 PCI-E 2.0 x 1 ASPM

This feature configures the ASPM (Active State Power Management) settings for the graphics devices installed on PCI-E 2.0 SLOT3, SLOT5, or SLOT7. The options are Disabled, L0s, L1, L0sL1 and **Auto**.

SLOT1/SLOT2 2.0 x 1 PCI ASPM

This feature configures the ASPM (Active State Power Management) settings for the graphics devices installed on PCI 2.0 x1 SLOT1 or SLOT2. The options are Disabled, L0s, L1, L0sL1 and **Auto**.

►Memory Configuration

This item displays the information on the memory modules installed on the motherboard.

- Memory RC Version
- Memory Frequency
- Total Memory
- Memory Voltage
- DIMMA1
- DIMMA2
- DIMMB1
- DIMMB2
- CAS Latency (tCL)
- Minimum Delay Time
 - CAS to RAS (tRODmin)
 - Row Precharge (tRPmin)
 - Active to Precharge (tRASmin)

Memory Frequency Limiter

This feature sets the limit of memory frequency for DIMM modules installed on the the motherboard. The options are **Auto**, 1067 (MHz), 1333 (MHz), and 1600 (MHz).

Max TOLUD (Top of Low Usable DRAM)

This feature sets the maximum TOLUD value, which specifies the "Top of Low Usable DRAM" memory space to be used by internal graphics devices, GTT Stolen Memory, and TSEG, respectively, if these devices are enabled. The options are Enabled and **Dynamic**, 1 GB, 1.25 GB, 1.5 GB, 1.75 GB, 2 GB, 2.25 GB, 2.5 GB, 2.75 GB, 3 GB and 3.25 GB.



Note: TSEG is a block of memory that is only accessible by the processor while operating in SMM mode.

Memory Scrambler

This feature enables or disables memory scrambler support for memory error correction. The settings are **Enabled** and Disabled.

►PCH-IO Configuration

This item displays the information for PCH-IO Chip.

- Intel PCH Rev ID
- USB Configuration
- USB Devices

EHCI1

Select Enabled to enable EHCI (Enhanced Host Controller Interface) Controller 1 for USB 2.0 support. One EHCI controller must always be enabled. The settings are **Enabled** and Disabled.

EHCI2

Select Enabled to enable EHCI (Enhanced Host Controller Interface) Controller 2 for USB 2.0 support. One EHCI controller must always be enabled. The settings are **Enabled** and Disabled..

Legacy USB Support

This feature enables support for legacy USB devices. Select Auto to disable legacy support if USB devices are not present. Select Disable to have USB devices available only for EFI applications. The options are **Enabled**, Disabled and Auto.

Port 60/64 Emulation

This feature enables or disables I/O port 60h/64h emulation support. This should be enabled for complete USB keyboard legacy support for non-USB-aware operating systems. The options are Disabled and **Enabled**.

XHCI Hand-Off

This item is a work-around solution for operating systems that do not support XHCI (Extensible Host Controller Interface) hand-off. The XHCI ownership change should be claimed by the XHCI driver. The settings are **Enabled** and Disabled.

EHCI Hand-Off

This item is for Operating Systems that do not support Enhanced Host Controller Interface (EHCI) hand-off. When this item is enabled, EHCI ownership change will be claimed by the EHCI driver. The settings are Enabled and **Disabled**.

XHCI Mode

This feature handles the operation mode for the XHCI (Extensible Host Controller Interface) controller. The settings are **Smart Auto**, Auto, Enabled, Disabled and Manual.

Frontside Audio Mode

This feature selects the type of audio output for the front_side audio header/connection. Select **HD Audio** for High Definition; otherwise, select AC '97 for legacy audio. The options are **HD Audio** and AC' 97.

Deep Sx

Use this feature to configure the deep sleep state modes for computer systems that are compliant with Advanced Configuration and Power Interface (ACPI) standards. The options are **Disabled**, Enabled in S5, and Enabled in S4-S5.

► On Board Chip Configuration

This item displays the On Board Chip options.

► ASMedia 1061 SATA Controller

ASMedia 1061 SATA Controller

Select Enabled to activate the onboard ASMedia SATA controller. The settings are **Enabled** and Disabled.

►SATA Configuration

When this submenu is selected, the AMI BIOS automatically detects the presence of the SATA Devices and displays the following items:

SATA Controllers

This item Enables or Disables the built-in SATA controllers on the motherboard. The options are **Enabled** and Disabled.

SATA Mode Selection

This item selects the mode for the installed SATA drives. The options are IDE, **AHCI** and RAID.

SATA RAID Option ROM/UEFI Driver (Available if the item above - SATA Mode Select is set to AHCI or RAID)

Select Enabled to use the SATA RAID Option ROM/UEFI driver for system boot. The options are **Enabled** and Disabled.

If the item above -SATA Mode Select is set to AHCI, the following items are displayed:

Serial ATA Port 0~ Port 5

This item displays the information detected on the installed SATA drives on the particular SATA port.

- Model number of drive and capacity
- Software Preserve Support

Port 0 ~ Port 5 Hot Plug

This feature designates the port specified for hot plugging. Set this item to Enabled for hot-plugging support, which will allow the user to replace a SATA disk drive without shutting down the system. The options are **Enabled** and Disabled.

Port 0 ~ Port 1 SATA Device Type

This feature configures the selected SATA port to support either a solid state drive or hard disk drive. The options are **Hard Disk Drive** and Solid Sate Drive.

Port 0 ~ Port 5 Spin Up Device

On an edge detect from 0 to 1, set this item to allow the PCH to start a COMRE-SET initialization sequence to the device. The options are Enabled and **Disabled**.

If the item above - **SATA Mode Select** is set to **IDE**, the following items are displayed:

Serial ATA Port 0~ Port 5

This item displays the information detected on the installed SATA drives on the particular SATA port.

- Model number of drive and capacity
- Software Preserve Support

If the item above - **SATA Mode Select** is set to **RAID**, the following items are displayed:

Serial ATA Port 0~ Port 5

This item displays the information detected on the installed SATA drives on the particular SATA port.

- Model number of drive and capacity
- Software Preserve Support

Port 0 ~ Port 5 Hot Plug

This feature designates this port for hot plugging. Set this item to Enabled for hot-plugging support, which will allow the user to replace a SATA drive without shutting down the system. The options are **Enabled** and Disabled.

Port 0 ~ Port 1 SATA Device Type

This feature configures the selected SATA port to support either a solid state drive or hard disk drive. Set this item to Enabled to enable hot-plugging. The options are **Hard Disk Drive** and Solid Sate Drive.

Port 0 ~ Port 5 Spin Up Device

On an edge detect from 0 to 1, set this item to allow the PCH to start a COMRESET initialization sequence to the device. The options are Enabled and **Disabled**.

►PCIe/PCI/PnP Configuration

This feature allows the user to set the PCI/PnP configurations for the following items:

Above 4G Decoding

Select Enabled for 64-bit devices to be decoded above the 4GB address space If 64bit PCI decoding is supported by the system. The options are **Disabled** and Enabled.

PCI Latency Timer

This feature sets the latency timer of each PCI device installed on a PCI bus. Select 64 to set the PCI latency to 64 PCI bus clock cycles. The options are **32 PCI Bus Clocks**, 64 PCI Bus Clocks, 96 PCI Bus Clocks, 128 PCI Bus Clocks, 160 PCI Bus Clocks, 192 PCI Bus Clocks, 224 PCI Bus Clocks and 248 PCI Bus Clocks.

VGA Palette Snoop

Select Enabled to support VGA palette register snooping which will allow the PCI cards that do not contain their own VGA color palette to examine the video cards palette and mimic it for proper color display. The options are **Disabled** and Enabled.

PERR# Generation

Select Enabled to allow a PCI device to generate a PERR number for a PCI Bus Signal Error Event. The options are **Disabled** and Enabled.

SERR# Generation

Select Enabled to allow a PCI device to generate an SERR number for a PCI Bus Signal Error Event. The options are **Enabled** and Disabled.

Slot 1 PCI 33MHz OPROM/Slot 2 PCI 33MHz OPROM

Use this feature to enable or disable PCI slot Option ROMs. This is to boot the computer using a device installed on the slot specified. The options are Disabled, **Legacy** and EFI.

Slot4 PCI-E 3.0 x8 (In x16) OPROM/Slot5 PCI-E 2.0 x1 OPROM/Slot6 PCI-E 3.0 x16 OPROM/Slot7 PCI-E 2.0 x1 OPROM

Use this feature to enable or disable PCIe slot Option ROMs to boot the computer using a device installed on the slot specified. The options are Disabled, **Legacy** and EFI.

Launch Storage OPROM Policy

This feature controls how the system executes UEFI (Unified Extensible Firmware Interface), and legacy storage OPROM. Select Legacy Only to boot the system using a legacy device installed in a PCI slot. The options are UEFI Only and **Legacy Only**.

Other PCI Device ROM Priority

This feature selects a PCI device OPROM to launch for system boot if this device is not a network, mass storage, or video device. The options are UEFI Only and **Legacy Only**.

Onboard LAN1/LAN2 Option ROM

Select iSCSI to use the iSCSI Option ROM to boot the computer using an iSCSI device installed in a LAN port specified. Select PXE (Preboot Execution Environment) to boot the computer using a PXE device installed in a LAN port specified. Select Disabled to prevent system boot using a device installed in a LAN port. The options are Disabled, PXE and iSCSI. The default setting for Onboard LAN1 Option ROM is **PXE**. The default setting for Onboard LAN2 Option ROM is **Disabled**.

Network Stack

Select Enabled enable PXE (Preboot Execution Environment) or UEFI (Unified Extensible Firmware Interface) for network stack support. The options are Enabled and **Disabled**.

►ACPI Settings

High Precision Event Timer

Select Enabled to activate the High Performance Event Timer (HPET) that produces periodic interrupts at a much higher frequency than a Real-time Clock (RTC) does in synchronizing multimedia streams, providing smooth playback and reducing the dependency on other timestamp calculation devices, such as an x86 RDTSC Instruction embedded in the CPU. The High Performance Event Timer is used to replace the 8254 Programmable Interval Timer. The options are **Enabled** and Disabled.

ACPI Sleep State

This feature selects the ACPI Sleep State that the system will enter into when the suspend button is activated. The options are Suspend Disabled, **S1 only (CPU Stop Clock)**, S3 only (suspend to RAM) and Both S1 and S3 (OS chooses which one).

WHEA Support

This feature Enables the Windows Hardware Error Architecture (WHEA) support for the Windows 2008 (or a later vision) operating system. The options are **Enabled** and Disabled.

►Trusted Computing Configuration (Available when a TPM Device is Detected and TPM Jumper is Enabled)

Configuration

Security Device Support

Select Enable for the AMI BIOS to automatically download the drivers needed to provide Trusted Computing platform support for this machine to ensure data integrity and network security. The options are **Disable** and Enable.

TPM State

Select Enabled to use TPM (Trusted Platform Module) settings for system data security. The options are Disabled and **Enabled**.



Note: The system will reboot for the change on TPM State to take effect.

Pending Operation

Use this item to schedule a TPM-related operation to be performed by a security device for TPM support. The options are **None**, Enable Take Ownership, Disable Take Ownership, and TPM Clear.



Note: The computer will reboot to carry out a pending TPM operation and change TPM state for a TPM device.

Current Status Information

This feature indicates the status of the following TPM items:

TPM Enabled Status

TPM Active Status

TPM Owner Status

Intel TXT (LT) Support

Intel TXT (Trusted Execution Technology) helps protect against software-based attacks to ensure the security, confidentiality, and integrity of all data stored in the system. The options are Enabled and **Disabled**.

►PCH-FW Configuration

The following information are displayed:

- ME FW Version
- ME Firmware Mode
- ME Firmware Type
- ME Firmware SKU
- PTT Capability /State

►Firmware Update Configuration

ME FW Image Re-Flash

Select Enable to re-flash the ME (Management Engine) Firmware. The options are **Disable** and **Enable**.

►AMT (Active Management Technology) Configuration

Intel AMT

Select Enabled to use Intel Active Management Technology (AMT) to enhance system performance. The options are **Enabled** and **Disabled**.

Activate Remote Assistance Process

Select Enabled for Remote Assistance support, which can trigger CIRA boot, allowing the system to boot via Client-Initiated Remote Access. The options are **Enabled** and **Disabled**.

AMT CIRA Timeout

This feature allows the user to set the Client-Initiated Remote Access (CIRA) Timeout setting. The default setting is **0**.

BIOS Hotkey Pressed

Select Enabled to use the BIOS Hotkey feature. The options are **Enabled** and **Disabled**.

Watch Dog Timer

Select Enabled to allow AMT (Advanced Management Technology) to reset or power down the system if the operating system or BIOS hangs or crashes. The options are **Disabled**, and **Enabled**.

OS Timer / BIOS Timer

These options appear if Watch Dog Timer (above) is enabled. This is a timed delay in seconds, before a system power down or reset after a BIOS or operating system failure is detected. Directly enter the value in seconds.

►Super IO Configuration

Super IO Chip NCT6776F

►Serial Port 1 Configuration /Serial Port 2 Configuration

Select Enabled to enable the onboard serial port. The options are **Enabled** and **Disabled**.

Change (Serial Port 1 / Serial Port 2) Settings

This option specifies the base I/O port address and the Interrupt Request address of Serial Port 1 and 2. Select Auto to let the BIOS automatically assign the base I/O and IRQ address.

The options for Serial Port 1 are **Auto**, (IO=3F8h; IRQ=4), (IO=3F8h; IRQ=3, 4, 5, 6, 7, 9, 10, 11, 12), (IO=2F8h; IRQ=3, 4, 5, 6, 7, 9, 10, 11, 12), (IO=3E8h; IRQ=3, 4, 5, 6, 7, 9, 10, 11, 12) and (IO=2E8h; IRQ=3, 4, 5, 6, 7, 9, 10, 11, 12).

The options for Serial Port 2 are **Auto**, (IO=2F8h; IRQ=3), (IO=3F8h; IRQ=3, 4, 5, 6, 7, 9, 10, 11, 12), (IO=2F8h; IRQ=3, 4, 5, 6, 7, 9, 10, 11, 12), (IO=3E8h; IRQ=3, 4, 5, 6, 7, 9, 10, 11, 12) and (IO=2E8h; IRQ=3, 4, 5, 6, 7, 9, 10, 11, 12).

►H/W (Hardware) Monitor

PC Health Status

Fan Speed Control Mode

This feature allows the user to decide how the system controls the speeds of the onboard fans. The CPU temperature and the fan speed are correlative. When the CPU on-die temperature increases, the fan speed will also increase for effective system cooling. Select "Full Speed" to allow the onboard fans to run at full speed (of 100% Pulse Width Modulation Duty Cycle) for maximum cooling. This setting is recommended for special system configuration or debugging. Select "Standard" for the onboard fans to run at 50% of the Initial PWM Cycle in order to balance the needs between system cooling and power saving. This setting is recommended for regular systems with normal hardware configurations. The options are Full Speed (@100% of PWM Cycle) and **Standard** (@50% of PWM Cycle).

The following items will be displayed:

- CPU Temperature (PECI)
- Front Side Sys. (System) Temperature
- Rear Side Sys. (System) Temperature
- PCH Temperature
- Fan1 Speed/Fan2 Speed/Fan3 Speed/Fan4 Speed/Fan5 Speed
- VCORE
- 12V

- VDIMM
- 5Vcc
- PCH 1.05V
- AVCC
- 3.3Vcc
- VSB
- VBAT

►Serial Port Console Redirection

COM1/COM2

Use this feature to enable console redirection for COM1 and COM2 ports. The options are Enabled and Disabled. The default setting is **Disabled**.

►Console Redirection Settings

This feature allows the user to specify how the host computer will exchange data with the client computer, which is the remote computer used by the user.

Terminal Type

This feature allows the user to select the target terminal emulation type for Console Redirection. Select VT100 to use the ASCII Character set. Select VT100+ to add color and function key support. Select ANSI to use the Extended ASCII Character Set. Select VT-UTF8 to use UTF8 encoding to map Unicode characters into one or more bytes. The options are ANSI, VT100, **VT100+**, and VT-UTF8.

Bits Per second

Use this feature to set the transmission speed for a serial port used in Console Redirection. Make sure that the same speed is used in the host computer and the client computer. A lower transmission speed may be required for long and busy lines. The options are 9600, 19200, 38400, 57600 and **115200** (bits per second).

Data Bits

Use this feature to set the data transmission size for Console Redirection. The options are 7 Bits and **8 Bits**.

Parity

A parity bit can be sent along with regular data bits to detect data transmission errors. Select Even if the parity bit is set to 0, and the number of 1's in data bits is even. Select Odd if the parity bit is set to 0, and the number of 1's in data bits is odd. Select None if you do not want to send a parity bit with your data bits in transmission. Select Mark to add a mark as a parity bit to be sent along with the data bits. Select Space to add a Space as a parity bit to be sent with your data bits. The options are **None**, Even, Odd, Mark and Space.

Stop Bits

A stop bit indicates the end of a serial data packet. Select 1 Stop Bit for standard serial data communication. Select 2 Stop Bits if slower devices are used. The options are **1** and 2.

Flow Control

This feature allows the user to set the flow control for Console Redirection to prevent data loss caused by buffer overflow. Send a "Stop" signal to stop sending data when the receiving buffer is full. Send a "Start" signal to start sending data when the receiving buffer is empty. The options are **None** and Hardware RTS/CTS.

VT-UTF8 Combo Key Support

Select Enabled to enable VT-UTF8 Combination Key support for ANSI/VT100 terminals. The options are **Enabled** and Disabled.

Recorder Mode

Select Enabled to capture the data displayed on a terminal and send it as text messages to a remote server. The options are **Disabled** and Enabled.

Resolution 100x31

Select Enabled for extended-terminal resolution support. The options are Disabled and **Enabled**.

Legacy OS Redirection Resolution

Use this feature to select the number of rows and columns used in Console Redirection for legacy OS support. The options are **80x24** and 80x25.

Putty KeyPad

This feature selects Function Keys and KeyPad settings for Putty, which is a terminal emulator designed for the Windows OS. The options are **VT100**, LINUX, XTERMR6, SC0, ESCN, and VT400.

Redirection After BIOS Post

Use this feature to enable or disable legacy console redirection after BIOS POST. When set to Bootloader, legacy console redirection is disabled before booting the OS. When set to Always Enable, legacy console redirection remains enabled when booting the OS. The options are **Always Enable** and Bootloader.

Serial Port for Out-of-Band Management/Windows Emergency Management Services (EMS)

The submenu allows the user to configure Console Redirection settings to support Out-of-Band Serial Port management.

Console Redirection (for EMS)

Select Enabled to use a COM Port selected by the user for Console Redirection. The options are Enabled and **Disabled**.

► Console Redirection Settings (for EMS)

This feature allows the user to specify how the host computer will exchange data with the client computer, which is the remote computer used by the user.

Out-of-Band Management Port

The feature selects a serial port used by the Microsoft Windows Emergency Management Services (EMS) to communicate with a remote server. The options are **COM1** and COM2.

Terminal Type

This feature allows the user to select the target terminal emulation type for Console Redirection. Select VT100 to use the ASCII character set. Select VT100+ to add color and function key support. Select ANSI to use the extended ASCII character set. Select VT-UTF8 to use UTF8 encoding to map Unicode characters into one or more bytes. The options are ANSI, VT100, VT100+, and **VT-UTF8**.

Bits Per Second

This item sets the transmission speed for a serial port used in Console Redirection. Make sure that the same speed is used in the host computer and the client computer. A lower transmission speed may be required for long and busy lines. The options are 9600, 19200, 57600, and **115200** (bits per second).

Flow Control

This feature allows the user to set the flow control for Console Redirection to prevent data loss caused by buffer overflow. Send a "Stop" signal to stop sending data when the receiving buffer is full. Send a "Start" signal to start sending data when the receiving buffer is empty. The options are **None**, Hardware RTS/CTS, and Software Xon/Xoff.

Data Bits, Parity, Stop Bits

The status of each item above is displayed.

4-4 Event Logs

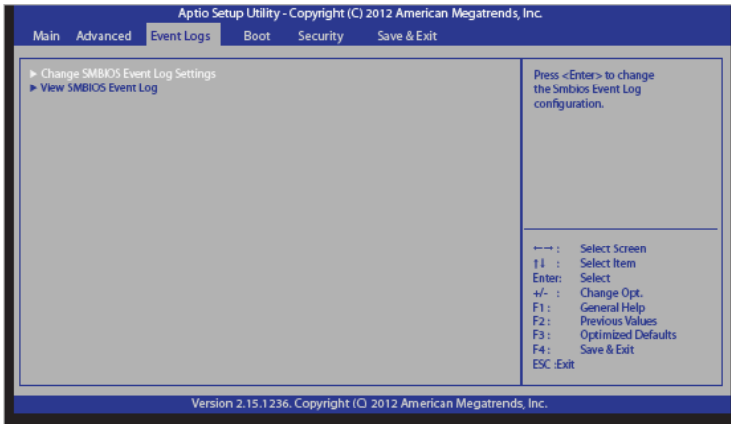

► Change SMBIOS Event Log Settings

Enabling/Disabling Options

SMBIOS Event Log

Change this item to enable or disable all features of the SMBIOS Event Logging during system boot. The options are **Enabled** and Disabled.

Erasing Settings

Erase Event Log

If No is selected, data stored in the event log will not be erased. Select Yes, Next Reset, data in the event log will be erased upon next system reboot. Select Yes, Every Reset, data in the event log will be erased upon every system reboot. The options are **No**, Yes, Next reset, and Yes, Every reset.

When Log is Full

Select Erase Immediately for all messages to be automatically erased from the event log when the event log memory is full. The options are **Do Nothing** and Erase Immediately.

SMBIOS Event Long Standard Settings

Log System Boot Event

This option toggles the System Boot Event logging to enabled or disabled. The options are **Disabled** and Enabled.

MECI

The Multiple Event Count Increment (MECI) counter counts the number of occurrences a duplicate event must happen before the MECI counter is incremented. This is a numeric value. The default value is **1**.

METW

The Multiple Event Time Window (METW) defines number of minutes must pass between duplicate log events before MECI is incremented. This is in minutes, from 0 to 99. The default value is **60**.

►View SMBIOS Event Log

This section displays the contents of the SMBIOS Event Log.

4-5 Boot Settings

Use this feature to configure Boot Settings:

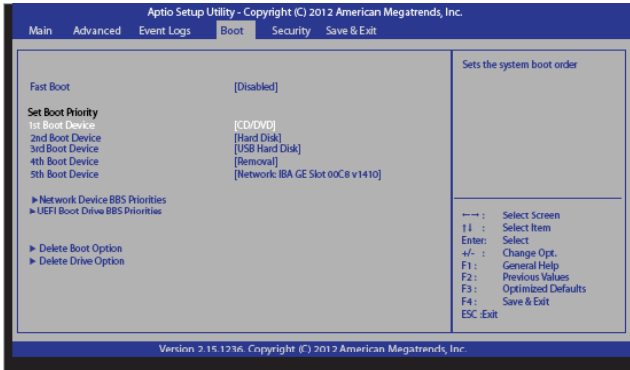

Set Boot Priority

This option prioritizes the order of bootable devices that the system to boot from. Press [ENTER] on each entry from top to bottom to select devices.

- 1st Boot Device
- 2nd Boot Device
- 3rd Boot Device
- 4th Boot Device
- 5th Boot Device
- 6th Boot Device

► Hard Disk Drive BBS Priorities

- 1st Device
- 2nd Device

► Network Device BBS Priorities

- 1st Device

► UEFI Boot Drive BBS Priorities

- 1st Boot Device

▶ **Delete Boot Option**

Use this feature to remove a pre-defined boot device from which the system will boot during startup.

The settings are [any pre-defined boot device]

▶ **Delete Driver Option**

This feature allows the user to delete a previously defined boot device from which the systems boots during startup.

The settings are [any pre defined boot device]

4-6 Security Settings

This menu allows the user to configure the following security settings for the system.

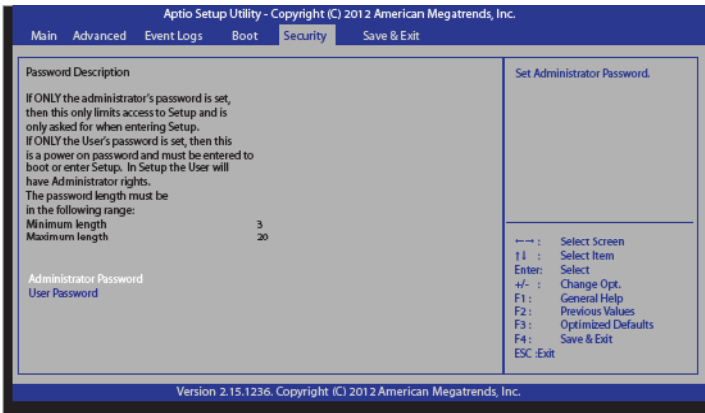

- If the Administrator password is defined ONLY - this controls access to the BIOS setup ONLY.
- If the User's password is defined ONLY - this password will need to be entered upon each system boot, and will also have Administrator rights in the setup.
- Passwords must be at least 3 and up to 20 characters long.

Administrator Password

Press Enter to create a new, or change an existing Administrator password.

HDD Security Configuration

Press Enter to create a new, or change an existing HDD password.

4-7 Save & Exit

Select the Exit tab from the BIOS Setup Utility screen to enter the Exit BIOS Setup screen.

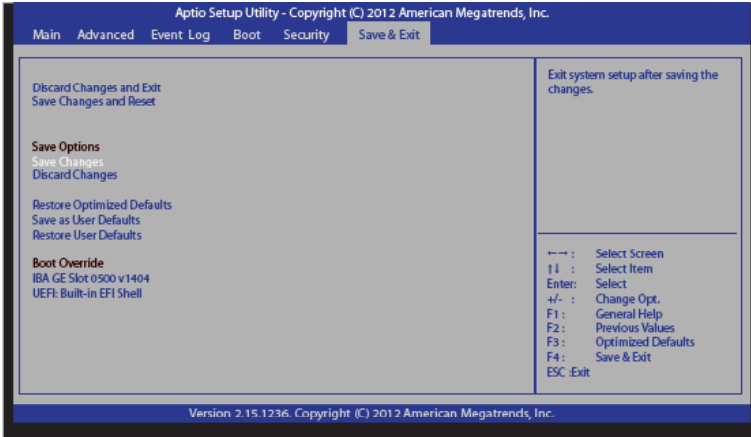

Discard Changes and Exit

Select this option to quit the BIOS Setup without making any permanent changes to the system configuration, and reboot the computer. Select Discard Changes and Exit from the Exit menu and press <Enter>.

Save Changes and Reset

When you have completed the system configuration changes, select this option to leave the BIOS Setup Utility and reboot the computer, so the new system configuration parameters can take effect. Select Save Changes and Exit from the Exit menu and press <Enter>.

Save Options

Save Changes

When you have completed the system configuration changes, select this option to save any changes made. This will not reset (reboot) the system.

Discard Changes

Select this option and press <Enter> to discard all the changes and return to the AMI BIOS Utility Program.

Restore Optimized Defaults

To set this feature, select Restore Defaults from the Exit menu and press <Enter>. These are factory settings designed for maximum system stability, but not for maximum performance.

Save As User Defaults

To set this feature, select Save as User Defaults from the Exit menu and press <Enter>. This enables the user to save any changes to the BIOS setup for future use.

Restore User Defaults

To set this feature, select Restore User Defaults from the Exit menu and press <Enter>. Use this feature to retrieve user-defined settings that were saved previously.

Boot Override

Listed on this section are other boot options for the system (i.e., Built-in EFI shell). Select an option and press <Enter>. Your system will boot to the selected boot option.

Notes

Appendix A

BIOS Error Beep Codes

During the POST (Power-On Self-Test) routines, which are performed each time the system is powered on, errors may occur.

Non-fatal errors are those which, in most cases, allow the system to continue with bootup. The error messages normally appear on the screen.

Fatal errors will not allow the system to continue to bootup. If a fatal error occurs, you should consult with your system manufacturer for possible repairs.

These fatal errors are usually communicated through a series of audible beeps. The numbers on the fatal error list correspond to the number of beeps for the corresponding error.

A-1 BIOS Error Beep Codes

BIOS Error Beep Codes		
Beep Code/LED	Error Message	Description
1 beep	Refresh	Circuits have been reset. (Ready to power up)
5 short beeps + 1 long beep	Memory error	No memory detected in the system
8 beeps	Display memory read/write error	Video adapter missing or with faulty memory
OH LED On	System OH	System Overheat

Notes

Appendix B

Software Installation Instructions

B-1 Installing Software Programs

The Supermicro ftp site contains drivers and utilities for your system at <ftp://ftp.supermicro.com>. Some of these must be installed, such as the chipset driver.

After accessing the ftp site, go into the CDR_Images directory and locate the ISO file for your motherboard. Download this file to create a CD/DVD of the drivers and utilities it contains. (You may also use a utility to extract the ISO file if preferred.)

Another option is to go to the Supermicro Website at <http://www.supermicro.com/products/>. Find the product page for your motherboard here, where you may download individual drivers and utilities.

After creating a CD/DVD with the ISO files, insert the disk into the CD/DVD drive on your system and the display shown below should appear.

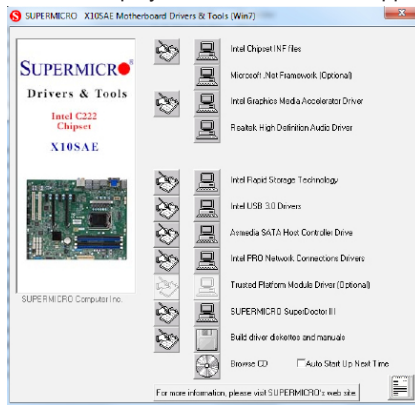

Driver/Tool Installation Display Screen



Note 1: Click the icons showing a hand writing on paper to view the readme files for each item. Click the computer icons to the right of these items to install each item (from top to the bottom) one at a time. **After installing each item, you must re-boot the system before moving on to the next item on the list.** The bottom icon with a CD on it allows you to view the entire contents.

Note 2: When making a storage driver diskette by booting into a Driver CD, please set the SATA Configuration to "Compatible Mode" and configure SATA as IDE in the BIOS Setup. After making the driver diskette, be sure to change the SATA settings back to your original settings.

B-2 Configuring SuperDoctor III

The SuperDoctor[®] III program is a web-based management tool that supports remote management capability. It includes Remote and Local Management tools. The local management is called SD III Client. The SuperDoctor III program allows you to monitor the environment and operations of your system. SuperDoctor III displays crucial system information such as CPU temperature, system voltages and fan status. See the figures below for examples of the SuperDoctor III interface.

 **Note 1:** The default User Name and Password for SuperDoctor III is ADMIN/ADMIN.

Note 2: When SuperDoctor III is first installed, it adopts the temperature threshold settings that have been set in BIOS. Any subsequent changes to these thresholds must be made within SuperDoctor III, as the SuperDoctor III settings override the BIOS settings. To set the BIOS temperature threshold settings again, you would first need to uninstall SuperDoctor III.



SuperDoctor[®] III Interface Display Screen (Health Information)



SuperDoctor® III Interface Display Screen (Remote Control)

 **Note:** The SuperDoctor III program and User's Manual can be downloaded from the Supermicro web site at <http://www.supermicro.com/products/accessories/software/SuperDoctorIII.cfm>. For Linux, we recommend that you use the SuperDoctor II application instead.

Notes

Appendix C

UEFI BIOS Recovery Instructions

Warning: Do not upgrade the BIOS unless your system has a BIOS-related issue. Flashing the wrong BIOS can cause irreparable damage to the system. In no event shall Supermicro be liable for direct, indirect, special, incidental, or consequential damages arising from a BIOS update. If you need to update the BIOS, do not shut down or reset the system while the BIOS is updating to avoid possible boot failure.

C-1 An Overview to the UEFI BIOS

The Unified Extensible Firmware Interface (UEFI) specification provides a software-based interface between the operating system and the platform firmware in the pre-boot environment. The UEFI specification supports an architecture-independent mechanism for add-on card initialization to allow the UEFI OS loader, which is stored in the add-on card, to boot up the system. UEFI offers a clean, hands-off control to a computer system at bootup.

C-2 How to Recover the UEFI BIOS Image (the Main BIOS Block)

A UEFI BIOS flash chip consists of a recovery BIOS block, comprised of two boot blocks and a main BIOS block (a main BIOS image). The boot block contains critical BIOS codes, including memory detection and recovery codes for the user to flash a new BIOS image if the original main BIOS image is corrupted. When the system power is on, the boot block codes execute first. Once that is completed, the main BIOS code will continue with system initialization and bootup.



Note: Follow the BIOS Recovery instructions below for BIOS recovery when the main BIOS boot crashes. However, when the BIOS boot block crashes, you will need to follow the procedures in Appendix D.

C-3 To Recover the Main BIOS Block Using a USB-Attached Device

This feature allows the user to recover a BIOS image using a USB-attached device without additional utilities used. A USB flash device such as a USB Flash Drive, or a USB CD/DVD ROM/RW device can be used for this purpose. However, a USB Hard Disk drive cannot be used for BIOS recovery at this time.

To perform UEFI BIOS recovery using a USB-attached device, follow the instructions below.

1. Using a different machine, copy the "Super.ROM" binary image file into the disc Root "\" Directory of a USB device or a writeable CD/DVD.

 **Note:** If you cannot locate the "Super.ROM" file in your driver disk, visit our website at www.supermicro.com to download the BIOS image into a USB flash device and rename it "Super ROM" for BIOS recovery use.

2. Insert the USB device that contains the new BIOS image ("Super.ROM") into your USB drive and power on the system
3. While powering on the system, keep pressing <Ctrl> and <Home> simultaneously on your keyboard until you hear two short beeps. This may take from a few seconds to one minute.
4. After locating the new BIOS binary image, the system will enter the BIOS Recovery menu as shown below.

 **Note:** At this point, you may decide if you want to start with BIOS Recovery. If you decide to proceed with BIOS Recovery, follow the procedures below.

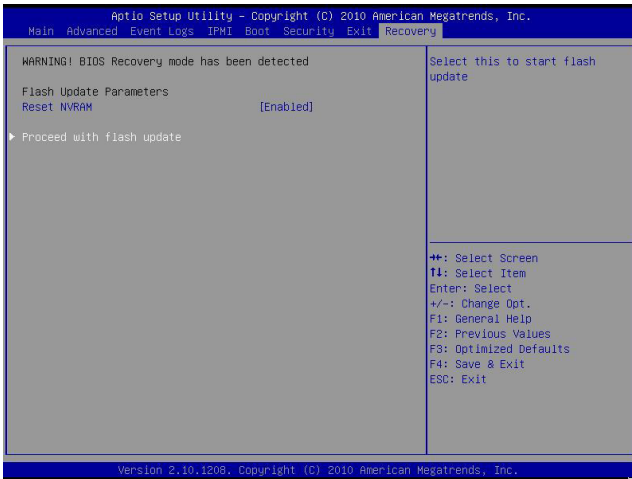

5. When the screen as shown above displays, using the arrow key, select the item- "Proceed with flash update" and press the <Enter> key. You will see the progress of BIOS Recovery as shown in the screen below.

 **Note:** Do not interrupt the process of BIOS flashing until it is completed.

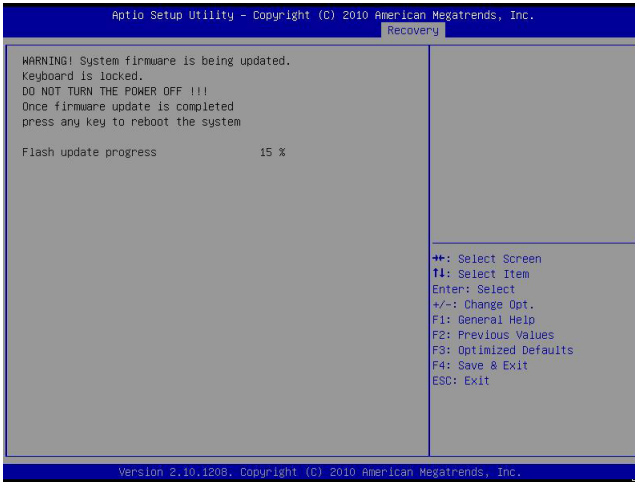

- After the process of BIOS Recovery is complete, press any key to reboot the system.

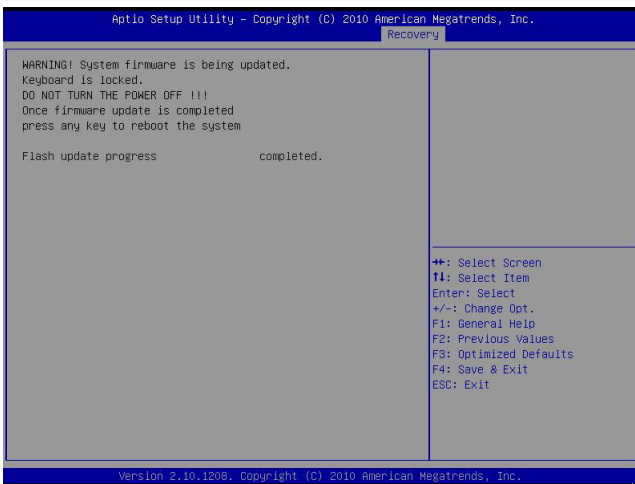

- Using a different system, extract the BIOS package into a bootable USB flash drive.
- When a DOS prompt appears, enter `AMI.BAT BIOSname.###` at the prompt.



Note: Do not interrupt this process until BIOS flashing is completed.

9. After seeing the message that BIOS update is completed, unplug the AC power cable from the power supply to clear CMOS, and then plug the AC power cable in the power supply again to power on the system.
10. Press continuously to enter the BIOS Setup utility.
11. Press <F3> to load default settings.
12. After loading default settings, press <F4> to save the settings and exit the BIOS Setup utility.

Appendix D

Dual Boot Block

D-1 Introduction

This motherboard supports the Dual Boot Block feature, which is the last-ditch mechanism to recover the BIOS boot block. This section provides an introduction to the feature.

BIOS Boot Block

A BIOS boot block is the minimum BIOS loader required to enable necessary hardware components for the BIOS crisis recovery flash that will update the main BIOS block. An on-call BIOS boot-block corruption may occur due to a software tool issue (see image below) or an unexpected power outage during BIOS updates.

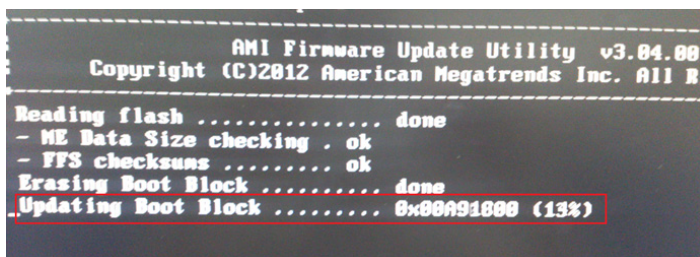

```
-----  
                AMI Firmware Update Utility v3.04.00  
                Copyright (C)2012 American Megatrends Inc. All Rights Reserved  
-----  
Reading flash ..... done  
- ME Data Size checking . ok  
- FFS checksums ..... ok  
Erasing Boot Block ..... done  
Updating Boot Block ..... 6x88A91800 (13%)
```

BIOS Boot Block Corruption Occurrence

When a BIOS boot block is corrupted due to an unexpected power outage or a software tool malfunctioning during BIOS updates, you can still reboot the system by closing pins 2 and 3 using a cap on Jumper JBR1. When JBR1 is set to pins 2 and 3, the system will boot from a backup boot block pre-loaded in the BIOS by the manufacturer.

D-2 Steps to Reboot the System by Using Jumper JBR1

1. Power down the system.
2. Close pins 2-3 on Jumper JBR1, and power on the system.
3. Follow the BIOS recovery SOP listed in the previous chapter (Appendix C).
4. After completing the steps above, power down the system.
5. Close pins 1-2 on Jumper JBR1, and power on the system.

(Disclaimer Continued)

The products sold by Supermicro are not intended for and will not be used in life support systems, medical equipment, nuclear facilities or systems, aircraft, aircraft devices, aircraft/emergency communication devices or other critical systems whose failure to perform be reasonably expected to result in significant injury or loss of life or catastrophic property damage. Accordingly, Supermicro disclaims any and all liability, and should buyer use or sell such products for use in such ultra-hazardous applications, it does so entirely at its own risk. Furthermore, buyer agrees to fully indemnify, defend and hold Supermicro harmless for and against any and all claims, demands, actions, litigation, and proceedings of any kind arising out of or related to such ultra-hazardous use or sale.