

SUPER  [®]

X10SLM+-F
X10SLM+-LN4F
X10SLL+-F

USER'S MANUAL

Revision 1.1a

The information in this User's Manual has been carefully reviewed and is believed to be accurate. The vendor assumes no responsibility for any inaccuracies that may be contained in this document, makes no commitment to update or to keep current the information in this manual, or to notify any person or organization of the updates. **Please Note: For the most up-to-date version of this manual, please see our web site at www.supermicro.com.**

Super Micro Computer, Inc. ("Supermicro") reserves the right to make changes to the product described in this manual at any time and without notice. This product, including software and documentation, is the property of Supermicro and/or its licensors, and is supplied only under a license. Any use or reproduction of this product is not allowed, except as expressly permitted by the terms of said license.

IN NO EVENT WILL SUPERMICRO BE LIABLE FOR DIRECT, INDIRECT, SPECIAL, INCIDENTAL, SPECULATIVE OR CONSEQUENTIAL DAMAGES ARISING FROM THE USE OR INABILITY TO USE THIS PRODUCT OR DOCUMENTATION, EVEN IF ADVISED OF THE POSSIBILITY OF SUCH DAMAGES. IN PARTICULAR, SUPERMICRO SHALL NOT HAVE LIABILITY FOR ANY HARDWARE, SOFTWARE, OR DATA STORED OR USED WITH THE PRODUCT, INCLUDING THE COSTS OF REPAIRING, REPLACING, INTEGRATING, INSTALLING OR RECOVERING SUCH HARDWARE, SOFTWARE, OR DATA.

Any disputes arising between manufacturer and customer shall be governed by the laws of Santa Clara County in the State of California, USA. The State of California, County of Santa Clara shall be the exclusive venue for the resolution of any such disputes. Super Micro's total liability for all claims will not exceed the price paid for the hardware product.

FCC Statement: This equipment has been tested and found to comply with the limits for a class B digital device, pursuant to Part 15 of the FCC Rules. These limits are designed to provide reasonable protection against harmful interference in a residential installation. This equipment generates, uses, and can radiate radio frequency energy and, if not installed and used in accordance with the instructions, may cause harmful interference to radio communications. However, there is no guarantee that interference will not occur in a particular installation. If this equipment does cause harmful interference to radio or television reception, which can be determined by turning the equipment off and on, the user is encouraged to try to correct the interference by one or more of the following measures:

- Reorient or relocate the receiving antenna.
- Increase the separation between the equipment and receiver.
- Connect the equipment to an outlet on a circuit different from that to which the receiver is connected.
- Consult the authorized dealer or an experienced radio/TV technician for help.

California Best Management Practices Regulations for Perchlorate Materials: This Perchlorate warning applies only to products containing CR (Manganese Dioxide) Lithium coin cells. "Perchlorate Material-special handling may apply. See www.dtsc.ca.gov/hazardouswaste/perchlorate"

WARNING: Handling of lead solder materials used in this product may expose you to lead, a chemical known to the State of California to cause birth defects and other reproductive harm.

Manual Revision: 1.1a

Release Date: May 24, 2016

Unless you request and receive written permission from Super Micro Computer, Inc., you may not copy any part of this document.

Information in this document is subject to change without notice. Other products and companies referred to herein are trademarks or registered trademarks of their respective companies or mark holders.

Copyright © 2016 by Super Micro Computer, Inc.

All rights reserved.

Printed in the United States of America

Preface

This manual is written for system integrators, IT technicians and knowledgeable end users. It provides information for the installation and use of the **SUPER** X10SLM+/X10SLL+ Motherboard.

About This Motherboard

The **SUPER** X10SLM+/X10SLL+ Motherboard Series supports a single 4th Generation Intel® E3-1200 V3 Series processor in an LGA 1150 (H3) socket. With the Intel® C220/C222/C224 Express chipset built in, the X10SLM+/X10SLL+ Motherboard Series supports Intel® Rapid Storage Technology, offering great system enhancement to Denlow Server platforms. Please refer to our website (<http://www.supermicro.com/products/>) for processor and memory support updates. This product is intended to be installed and serviced by professional technicians.

Manual Organization

Chapter 1 describes the features, specifications and performance of the motherboard, and provides detailed information on the Intel® C220/C222/C224 Express chipset.

Chapter 2 provides hardware installation instructions. Read this chapter when installing the processor, memory modules and other hardware components into the system. If you encounter any problems, see **Chapter 3**, which describes troubleshooting procedures for video, memory and system setup stored in the CMOS.

Chapter 4 includes an introduction to the BIOS, and provides detailed information on running the CMOS Setup utility.

Appendix A provides BIOS Error Beep Codes.

Appendix B lists software program installation instructions.

Appendix C contains UEFI BIOS Recovery instructions.

Appendix D provides Dual BIOS Boot Block information for BIOS crisis recovery.

Conventions Used in the Manual:

Special attention should be given to the following symbols for proper installation and to prevent damage done to the components or injury to yourself:

Warning: Critical information to prevent damage to the components or injury to yourself.



Important: Important information given to ensure proper system installation or to relay safety precautions.



Note: Additional Information given to differentiate various models or provides information for correct system setup.

Contacting Supermicro

Headquarters

Address: Super Micro Computer, Inc.
980 Rock Ave.
San Jose, CA 95131 U.S.A.

Tel: +1 (408) 503-8000

Fax: +1 (408) 503-8008

Email: marketing@supermicro.com (General Information)
support@supermicro.com (Technical Support)

Web Site: www.supermicro.com

Europe

Address: Super Micro Computer B.V.
Het Sterrenbeeld 28, 5215 ML
's-Hertogenbosch, The Netherlands

Tel: +31 (0) 73-6400390

Fax: +31 (0) 73-6416525

Email: sales@supermicro.nl (General Information)
support@supermicro.nl (Technical Support)
rma@supermicro.nl (Customer Support)

Web Site: www.supermicro.nl

Asia-Pacific

Address: Super Micro Computer, Inc.
3F, No. 150, Jian 1st Rd.
Zhonghe Dist., New Taipei City 235
Taiwan (R.O.C)

Tel: +886-(2) 8226-3990

Fax: +886-(2) 8226-3992

Email: support@supermicro.com.tw

Web Site: www.supermicro.com.tw

Table of Contents

Preface

About This Motherboard.....	iii
Manual Organization	iii
Conventions Used in the Manual:.....	iv
Contacting Supermicro.....	v

Chapter 1 Introduction

1-1 Overview	1-1
Checklist.....	1-1
Motherboard Features.....	1-7
1-2 Chipset Overview	1-13
1-3 Special Features	1-14
1-4 PC Health Monitoring.....	1-14
1-5 ACPI Features.....	1-15
1-6 Power Supply.....	1-15
1-7 Super I/O.....	1-16
1-8 Advanced Power Management.....	1-16

Chapter 2 Installation

2-1 Standardized Warning Statements	2-1
Battery Handling.....	2-1
Product Disposal	2-3
2-2 Static-Sensitive Devices.....	2-4
Precautions	2-4
Unpacking	2-4
2-3 Processor and Heatsink Installation.....	2-5
Installing the LGA1150 Processor	2-5
Installing an Active CPU Heatsink with Fan	2-8
Removing the Heatsink.....	2-10
2-4 Installing DDR3 Memory	2-11
DIMM Installation	2-11
Removing Memory Modules	2-12
Memory Support.....	2-12
Memory Population Guidelines	2-12
2-5 Motherboard Installation.....	2-14
Tools Needed	2-14
Location of Mounting Holes	2-14
Installing the Motherboard	2-15

2-6	Connectors/IO Ports.....	2-16
	Backplane I/O Panel.....	2-16
	Serial Ports.....	2-17
	Video Connection.....	2-17
	Universal Serial Bus (USB).....	2-18
	Ethernet Ports.....	2-19
	Unit Identifier Switch/UID LED Indicators.....	2-20
	Front Control Panel.....	2-21
	Front Control Panel Pin Definitions.....	2-22
	NMI Button.....	2-22
	Power LED.....	2-22
	HDD LED.....	2-22
	NIC1/NIC2 LEDs.....	2-22
	Overheat (OH)/Fan Fail/PWR Fail/UID LED.....	2-23
	Reset Button.....	2-23
	Power Button.....	2-23
2-7	Connecting Cables.....	2-24
	ATX Main PWR & CPU PWR Connectors (JPW1 & JPW2).....	2-24
	Fan Headers (Fan 1- Fan 4/Fan A).....	2-25
	Chassis Intrusion (JL1).....	2-25
	Internal Buzzer (SP1).....	2-26
	Onboard Power LED (JLED1).....	2-26
	DOM PWR Connector (JSD1).....	2-27
	Standby Power Header.....	2-27
	T-SGPIO 1/2 Headers.....	2-28
	TPM Header/Port 80 Header.....	2-28
	Power SMB (I ² C) Connector.....	2-29
	LAN3 / LAN4 LED Header.....	2-29
2-8	Jumper Settings.....	2-30
	Explanation of Jumpers.....	2-30
	GLAN Enable/Disable.....	2-30
	Clear CMOS (JBT1).....	2-31
	PCI Slot SMB Enable (I ² C1/I ² C2).....	2-31
	Watch Dog Enable/Disable.....	2-32
	VGA Enable.....	2-32
	Management Engine (ME) Recovery.....	2-33
	Manufacture (ME) Mode Select.....	2-33
	BIOS Recovery Enable.....	2-34
	LAN Firmware Upgrade.....	2-35

2-9	Onboard Indicators.....	2-36
	LAN1/LAN2 LEDs.....	2-36
	Dedicated IPMI LAN LEDs.....	2-36
	Onboard Power LED (LE3)	2-37
	IPMI Heartbeat LED.....	2-37
	Unit ID (UID) LED	2-37
2-10	SATA Connections.....	2-38
	SATA 3.0 Connections.....	2-38

Chapter 3 Troubleshooting

3-1	Troubleshooting Procedures.....	3-1
3-2	Technical Support Procedures.....	3-3
3-3	Frequently Asked Questions.....	3-4
3-4	Battery Removal and Installation.....	3-5
3-5	Returning Merchandise for Service.....	3-6

Chapter 4 BIOS

4-1	Introduction.....	4-1
4-2	Main Setup.....	4-2
4-3	Advanced Setup Configurations.....	4-4
4-4	Event Logs.....	4-23
4-5	IPMI.....	4-25
4-6	Boot Settings.....	4-28
4-7	Security Settings	4-30
4-8	Save & Exit	4-31

Appendix A BIOS Error Beep Codes

A-1	BIOS Error Beep Codes	A-1
-----	-----------------------------	-----

Appendix B Software Installation Instructions

B-1	Installing Software Programs.....	B-1
B-2	Configuring SuperDoctor III	B-2

Appendix C UEFI BIOS Recovery Instructions

C-1	An Overview to the UEFI BIOS	C-1
C-2	How to Recover the UEFI BIOS Image (-the Main BIOS Block).....	C-1
C-3	To Recover the Main BIOS Block Using a USB-Attached Device.....	C-1

Appendix D Dual Boot Block

D-1	Introduction.....	D-1
	BIOS Boot Block	D-1
	BIOS Boot Block Corruption Occurrence	D-1
D-2	Steps to Reboot the System by Using Jumper JBR1	D-2

Chapter 1

Introduction

1-1 Overview

Checklist

Congratulations on purchasing your computer motherboard from an acknowledged leader in the industry. Supermicro boards are designed with the utmost attention to detail to provide you with the highest standards in quality and performance.

Please check that the following items have all been included with your motherboard. If anything listed here is damaged or missing, contact your retailer.

The following items are included in the retail box:

- One (1) Supermicro Motherboard
- Six (6) SATA cables
- One (1) I/O shield
- One (1) Quick Reference Guide



Note: For your system to work properly, please follow the links below to download all necessary drivers/utilities and the user's manual for your motherboard.

SMCI product manuals: <http://www.supermicro.com/support/manuals/>

Product Drivers and utilities: <ftp://ftp.supermicro.com/>

If you have any questions, please contact our support team at support@supermicro.com.

SUPER X10SLM+-LN4F Motherboard Series Image

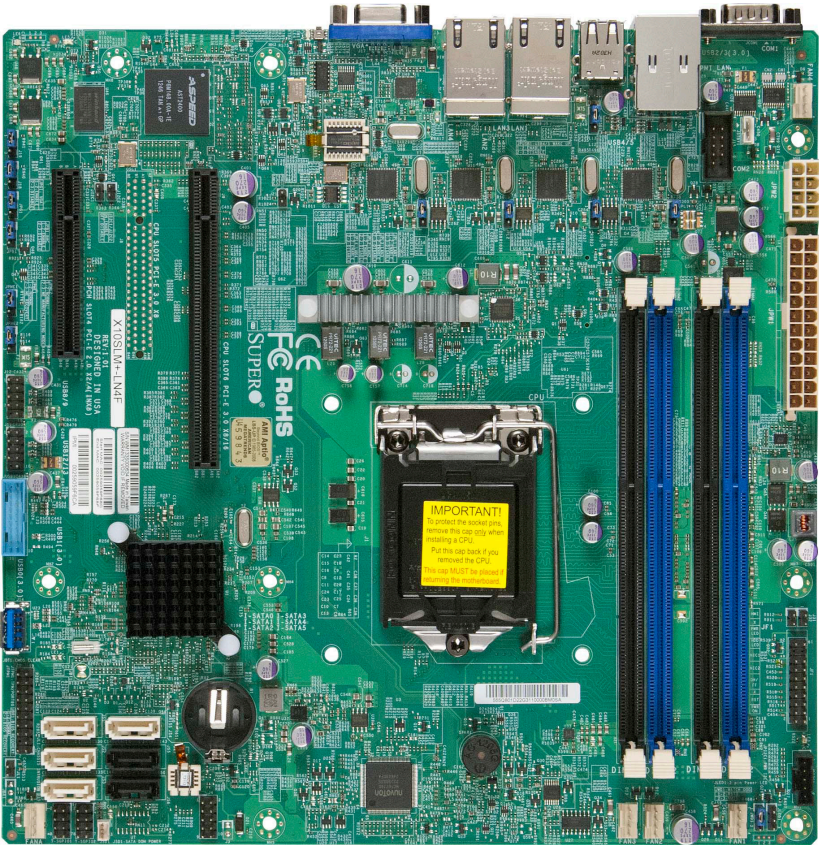

Note: All graphics shown in this manual were based upon the latest PCB Revision available at the time of publishing of the manual. The motherboard you've received may or may not look exactly the same as the graphics shown in this manual.

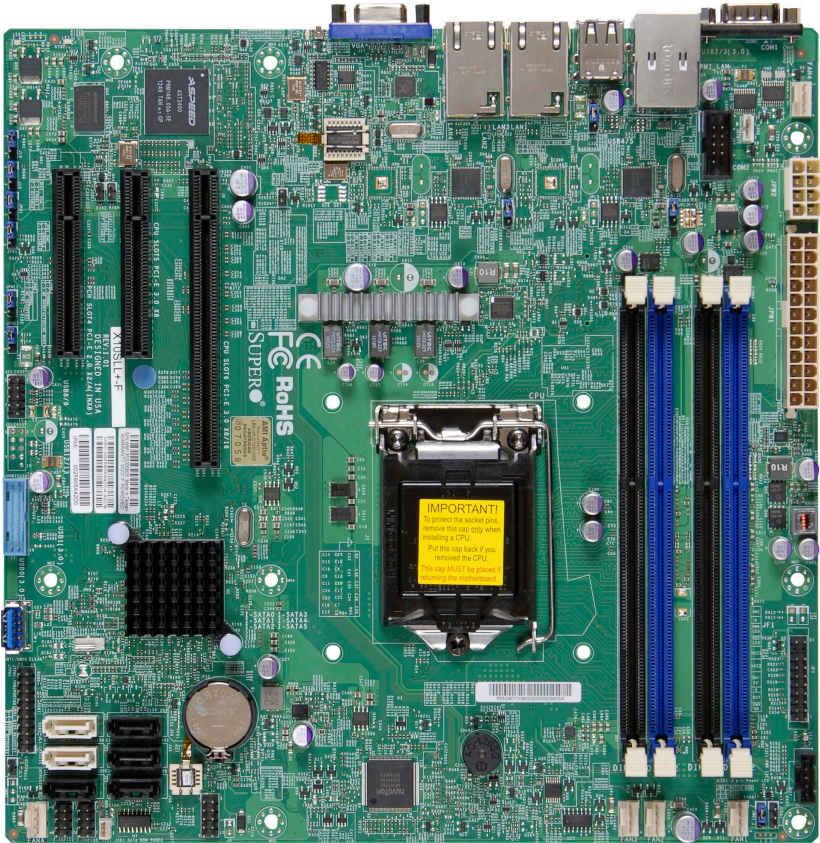
SUPER X10SLM+-F/X10SLL+-F Motherboard Series Image

Note: All graphics shown in this manual were based upon the latest PCB Revision available at the time of publishing of the manual. The motherboard you've received may or may not look exactly the same as the graphics shown in this manual.

Quick Reference

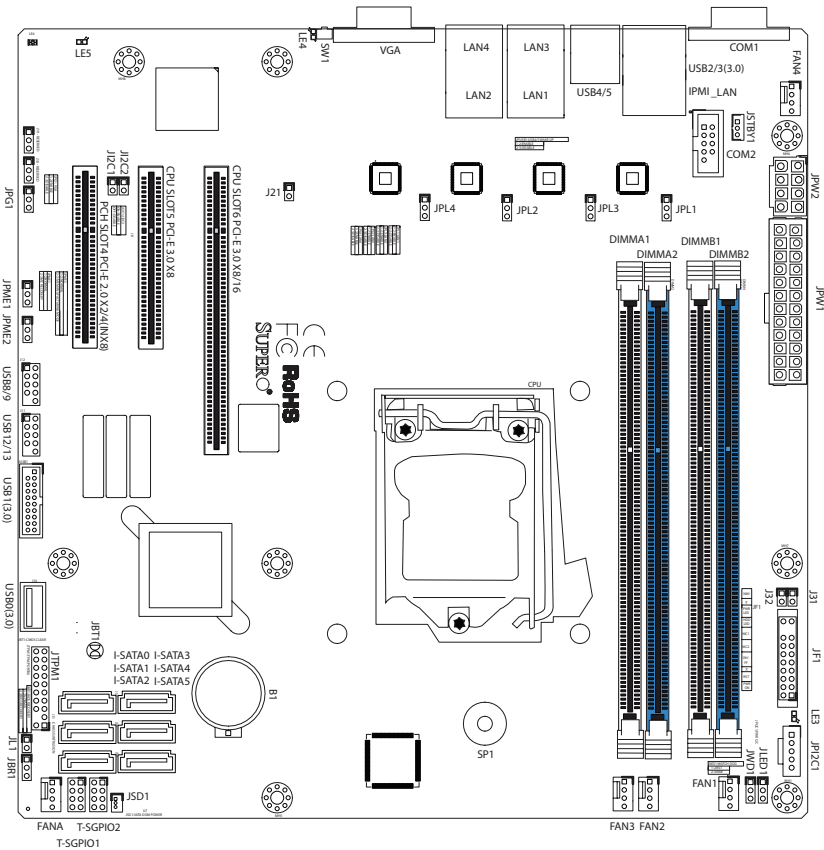

Important Notes to the User

- See Chapter 2 for detailed information on jumpers, I/O ports and JF1 front panel connections.
- "■" indicates the location of "Pin 1".
- Jumpers/components not indicated are for testing only.
- When LE3 (Onboard Power LED Indicator) is on, system power is on. Unplug the power cable before installing or removing any components.

Connectors	
Back Panel I/O	See Back Panel I/O Connectors, below right
COM2	COM2 Port Header
Fan A, Fan1~Fan4	System/CPU Fan Headers (Fan 1: CPU Fan)
JL1	Chassis Intrusion Header
JPW1	24-pin ATX Main Power Connector (Required)
JPW2	+12V 8-pin CPU power Connector (Required)
JSD1	SATA DOM (Device_On_Module) Power Connector
JSTBY1	Standby Power Header
JTPM1	Trusted Platform Module/Port 80 Connector
SP1	Internal Speaker/Buzzer
I-SATA 0~I-SATA5	Serial ATA Ports 0~3 (6Gb/sec), Ports 4/5 (3Gb/sec) (X10SLM+ series only) Serial ATA Ports 0/1 (6Gb/sec), Ports 3~5 (3Gb/sec) (X10SSL+-F only)
T-SGPIO 1/2	Serial_Link General Purpose I/O Connection Headers 1/2
USB 8/9, 12/13	Front Panel USB 2.0 Headers, USB Ports 8/9, 12/13
USB 1	Front Panel USB 3.0 Header, USB Port 1
USB 0	Type A USB 3.0 Connector, USB Port 0
JPI2C1	Power Supply SMBbus I2C Header
B1	Battery
JF1	Front Panel Control Header
J31	Active LED Header for LAN4
J32	Active LED HEader for LAN3
JLED1	Onboard Power LED Header
PCH Slot 4	PCI-E 2.0 x2 (in x8) Expansion Slot (-LN4F only) PCI-E 2.0 x4 (in x8) Expansion Slot (-F only)
CPU Slot 5	PCI-E 3.0 x8 Expansion Slot (-F only)
CPU Slot 6	PCI-E 3.0 x16 Expansion Slot (-LN4F only) PCI-E 3.0 x8 (in x16) Expansion Slot (-F only)

LED Indicators			
LE3	Power LED	Green: Solid on	Power On
LE4	Unit ID (UID) LED	Blue: On	UID Switch On
LE5	BMC Heartbeat	Green: Blinking	BMC On/Normal

Jumpers		
JBR1	BIOS Recovery	Pins 1-2 (Normal)
JBT1	CMOS Clear	Short pin pads to reset CMOS
JJ ² C1/JJ ² C2	SMB to PCI Slots	Off (Disabled)
JPL1/JPL2	LAN1/LAN2 Enable	Pins 1-2 (Enabled)
JPL3/JPL4	LAN3/LAN4 Enable (-LN4F only)	Pins 1-2 (Enabled)
JPME1	Management Engine (ME) Recovery	Pins 1-2 (Normal)
JPME2	Manufacture Engine (ME) Mode Select	Pins 1-2 (Normal)
JWD1	Watch Dog Reset Timer Enable	Pins 2-3 (NMI)
JPG1	VGA Enable/Disable	Pins 1-2 (Enabled)
SW1	Unit ID (UID) LED Switch	Toggle On or Off (for UID LED)
J21	LAN Firmware Update Jumper	Open (Disabled)

Motherboard Features

CPU	Single Intel® Xeon E3-1200 v3 and 4th Generation Core i3, Pentium, Celeron processors in a LGA1150 H3 socket	
Memory	Four (4) SDRAM slots support up to 32 GB of DDR3 Unbuffered ECC 1600/1333 MHz (1.35V/1.5V) memory	
	Dual-channel memory	
	DIMM sizes	
	UDIMM	1 GB, 2 GB, 4GB, and 8GB
Chipset	Intel® C224 Express (X10SLM+ Series), Intel® C222 Express (X10SLL+ Series), Intel® C220 Express (X10SLM+LN4F Series)	
Expansion Slots	<ul style="list-style-type: none"> • One (1) PCI-E 2.0 x2 (in x8) (-LN4F only) • One (1) PCI-E 3.0 x16 (-LN4F only) • One (1) PCI-E 2.0 x4 (in x8) (-F only) • One (1) PCI-E 3.0 x8 (-F only) • One (1) PCI-E 3.0 x8 (in x16) (-F only) 	
Network Connections	Intel i210 Gigabit Ethernet Controllers:	
	<ul style="list-style-type: none"> • Two (2) LAN controllers for LAN1/LAN2 (-F only) • Four (4) LAN controllers for LAN3/LAN4 (-LN4F only) 	
	<ul style="list-style-type: none"> • Two (2) or Four (4) (X10-SLM+-LN4F only) RJ-45 rear I/O panel connectors with Link and Activity LEDs • One (1) IPMI LAN Connector (Realtek 8211E-PHY) 	
I/O Devices	SATA Support	
	X10SLM+ Series	
	SATA 3.0 (6Gb/s)	Four (4) I-SATA 0-3 with Intel Rapid Storage Technology support. Supports RAID 0, 1, 5, 10.
	SATA 2.0 (3Gb/s)	Two (2) I-SATA 4/5 with Intel Rapid Storage Technology support. Supports RAID 0, 1.
	X10SLL+ Series	
	SATA 3.0 (6Gb/s)	Two (2) I-SATA 0-1 with Intel Rapid Storage Technology support. Supports RAID 0, 1.
	SATA 2.0 (3Gb/s)	Four (4) I-SATA 3~5 with Intel Rapid Storage Technology support. Supports RAID 0, 1, 5, 10.

	<p>USB Devices</p> <p>X10SLM+ Series</p> <p>Four (4) USB 3.0 ports: Two (2) USB ports on the rear I/O back panel, One (1) internal header and one (1) Type A port.</p> <p>Six (6) USB 2.0 ports: Two (2) USB ports on the rear I/O panel, and 4 ports on Two (2) internal headers.</p> <p>X10SLL+ Series</p> <p>Two (2) USB 3.0 ports: One (1) internal header and one (1) Type A port.</p> <p>Six (6) USB 2.0 ports: Four (4) USB ports on the rear I/O back panel, and 2 ports on one (1) internal header.</p> <p>Serial (COM) Ports</p> <p>One (1) front accessible serial port header (COM2), and one (1) serial port on the I/O back panel.</p> <p>Super I/O</p> <p>Nuvoton NCT6776</p>
BIOS	<p>64 Mb AMI BIOS® SPI Flash BIOS</p> <p>Plug and Play (PnP), DMI 2.3, ACPI 1.0, USB Keyboard and SMBIOS 2.3</p>
Power Configuration	<p>ACPI/ACPM Power Management</p> <p>Main Switch Override Mechanism</p> <p>Keyboard Wake-up from Soft-Off</p> <p>Internal/External Modem Ring-On</p> <p>Power-on mode for AC power recovery</p>
PC Health Monitoring	<p>CPU Monitoring</p> <p>Onboard voltage monitors for CPU core, +3.3V, +5V, +/-12V, +3.3V Stdbv, +5V Stdbv, VBAT, Memory, Chipset</p> <p>CPU 3-phase switching voltage regulator</p> <p>CPU/System overheat LED and control</p> <p>CPU Thermal Trip support</p> <p>Thermal Monitor 2 (TM2) support</p> <p>Fan Control</p> <p>Fan status monitoring for speed and on/off control, Five (5) 4-pin fan headers</p> <p>Low noise fan speed control</p>

System Management	PECI (Platform Environment Configuration Interface) 3.0 support
	System resource alert via SuperDoctor® III
	SuperDoctor® III (download), Watch Dog, NMI
	Chassis Intrusion header and detection
Software Utilities	BIOS flash upgrade utility (download)
Other	ROHS 6/6 (Full Compliant, Lead Free)
Dimensions	ATX form factor (9.6" x 9.6") (243.84 mm x 243.84 mm)

Block Diagram - X10SLM+ Series

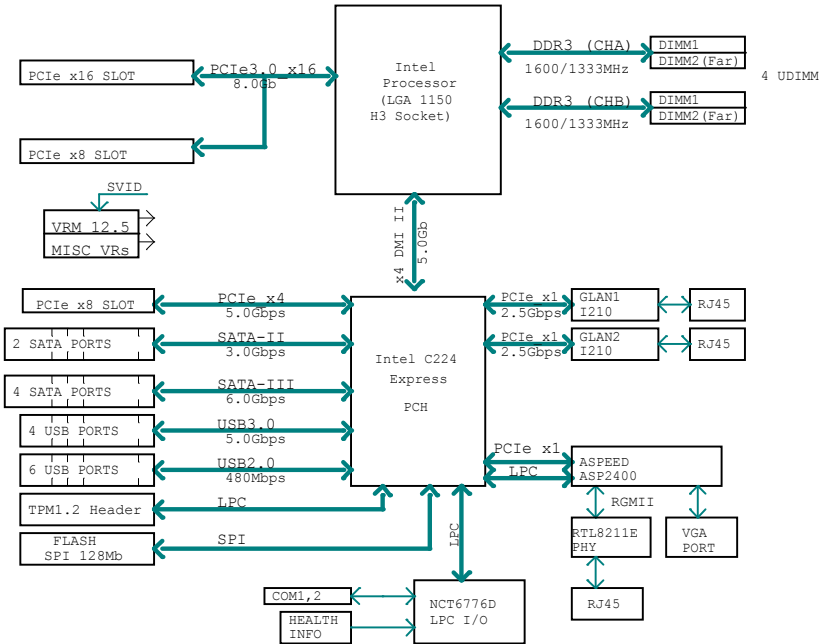

System Block Diagram



Note: This is a general block diagram and may not exactly represent the features on your motherboard. See the Motherboard Features pages for the actual specifications of each motherboard.

Block Diagram - X10SLL+ Series

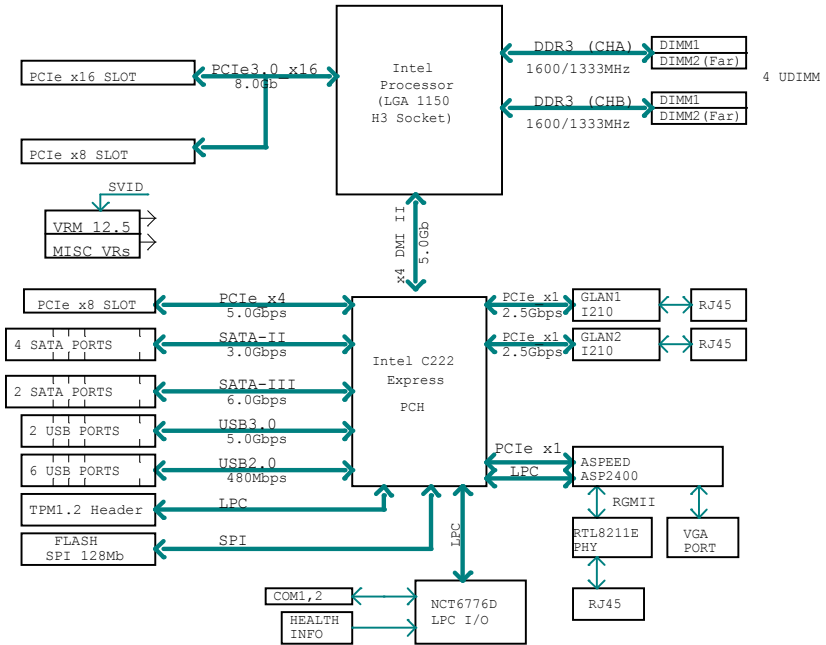

System Block Diagram



Note: This is a general block diagram and may not exactly represent the features on your motherboard. See the Motherboard Features pages for the actual specifications of each motherboard.

Block Diagram - X10SLM+ -LN4F Series

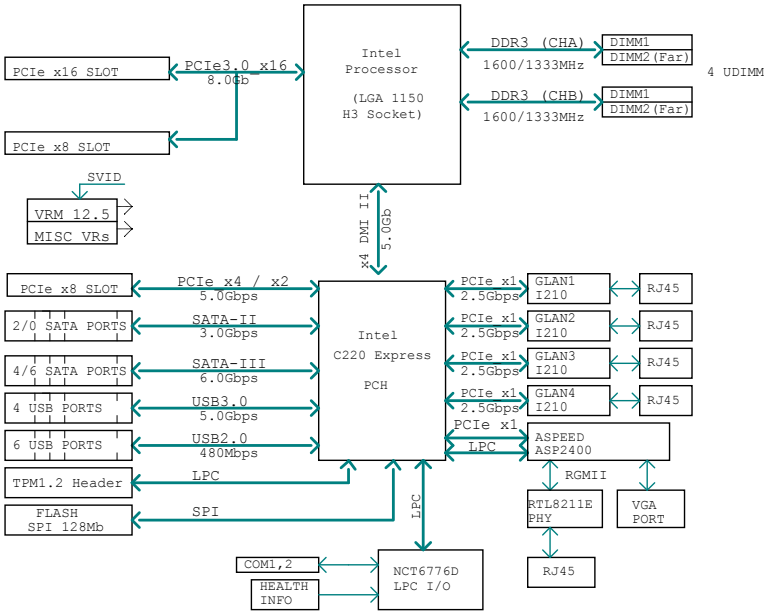

System Block Diagram



Note: This is a general block diagram and may not exactly represent the features on your motherboard. See the Motherboard Features pages for the actual specifications of each motherboard.

1-2 Chipset Overview

The X10SLM+/X10SLL+ Motherboard Series supports a single Intel® Xeon E3-1200 v3 and 4th Generation Core i3, Pentium, Celeron processors in a LGA1150 H3 socket. Built upon the functionality and the capability of the C220/C222/C224 Express chipset, the motherboard provides substantial enhancement to system performance and storage capability for high performance platforms in a sleek package.

The high-speed Direct Media Interface (DMI) featured in the Intel® C220/C222/C224 Express chipset supports high-speed Direct Media Interface (DMI) for chip-to-chip true isochronous communication, providing up to 10 Gb/s of software-transparent data transfer rate on each read/write direction. In addition, the X10SLM+/X10SLL+ Motherboard Series also features a TCO timer which allows the system to recover from a software/hardware lock and perform tasks, including Function Disable and Intruder Detect.

Intel® C220/C222/C224 Express Chipset Features

- Direct Media Interface (up 10 Gb/s transfer, Full Duplex)
- Intel® Matrix Storage Technology and Intel Rapid Storage Technology
- Dual NAND Interface
- Intel® I/O Virtualization (VT-d) Support
- Intel® Rapid Storage Technology Support
- Intel® Trusted Execution Technology Support
- PCI Express 2.0 Interface (up to 5.0 GT/s)
- SATA Controller (up to 6Gb/sec)
- Advanced Host Controller Interface (AHCI)
- Intel® Active Management Technology (iAMT) 9.0 and vPRO 9.0 support

1-3 Special Features

Recovery from AC Power Loss

Basic I/O System (BIOS) provides a setting for you to determine how the system will respond when AC power is lost and then restored to the system. You can choose for the system to remain powered off, (in which case you must press the power switch to turn it back on), or for it to automatically return to a power-on state. See the Advanced BIOS Setup section to change this setting. The default setting is **Last State**.

1-4 PC Health Monitoring

This section describes the PC health monitoring features of the board. All have an onboard System Hardware Monitoring chip that supports PC health monitoring. An onboard voltage monitor will scan these onboard voltages continuously: CPU Vcore, 12V, -12V, 5V, 3.3V, 3.3VSB, memory and battery voltages. Once a voltage becomes unstable, a warning is given, or an error message is sent to the screen. The user can adjust the voltage thresholds to define the sensitivity of the voltage monitor.

Fan Status Monitor with Firmware Control

PC health monitoring in the BIOS can check the RPM status of the cooling fans. The onboard CPU and chassis fans are controlled by Thermal Management via IPMI Firmware.

Environmental Temperature Control

The thermal control sensor monitors the CPU temperature in real time and will turn on the thermal control fan whenever the CPU temperature exceeds a user-defined threshold. The overheat circuitry runs independently from the CPU. Once the thermal sensor detects that the CPU temperature is too high, it will automatically turn on the thermal fans to prevent the CPU from overheating. The onboard chassis thermal circuitry can monitor the overall system temperature and alert the user when the chassis temperature is too high.



Note: To avoid possible system overheating, please be sure to provide adequate airflow to your system.

System Resource Alert

This feature is available when the system is used with SuperDoctor® III in the Windows OS environment or used with SuperDoctor II in Linux. SuperDoctor is used to notify the user of certain system events. For example, you can also configure SuperDoctor to provide you with warnings when the system temperature, CPU temperatures, voltages and fan speeds go beyond predefined thresholds.

1-5 ACPI Features

ACPI stands for Advanced Configuration and Power Interface. The ACPI specification defines a flexible and abstract hardware interface that provides a standard way to integrate power management features throughout a PC system, including its hardware, operating system and application software. This enables the system to automatically turn on and off peripherals such as CD-ROMs, network cards, hard disk drives and printers.

In addition to enabling operating system-directed power management, ACPI also provides a generic system event mechanism for Plug and Play, and an operating system-independent interface for configuration control. ACPI leverages the Plug and Play BIOS data structures, while providing a processor architecture-independent implementation that is compatible with Windows 7, Windows 8, and Windows 2008 Operating Systems.

Slow Blinking LED for Suspend-State Indicator

When the CPU goes into a suspend state, the chassis power LED will start to blink to indicate that the CPU is in suspend mode. When the user presses any key, the CPU will "wake up", and the LED will automatically stop blinking and remain on.

1-6 Power Supply

As with all computer products, a stable power source is necessary for proper and reliable operation. It is even more important for processors that have high CPU clock rates.

This motherboard accommodates 24-pin ATX power supplies. Although most power supplies generally meet the specifications required by the CPU, some are inadequate. In addition, the 12V 8-pin power connector located at JPW2 is also required to ensure adequate power supply to the system. Also your power supply must supply 1.5A for the Ethernet ports.

Warning: 1. To prevent damage to the power supply or motherboard, please use a power supply that contains a 24-pin and a 8-pin power connectors. Be sure to connect these connectors to the 24-pin (JPW1) and the 8-pin (JPW2) power connectors on the

motherboard. Failure in doing so will void the manufacturer warranty on your power supply and motherboard. 2. To provide adequate power to SATA devices, please connect the SATA DOM PWR connector (JSD1) to the power supply.

It is strongly recommended that you use a high quality power supply that meets ATX power supply Specification 2.02 or above. It must also be SSI compliant. (For more information, please refer to the web site at <http://www.ssiforum.org/>). Additionally, in areas where noisy power transmission is present, you may choose to install a line filter to shield the computer from noise. It is recommended that you also install a power surge protector to help avoid problems caused by power surges.

1-7 Super I/O

The Super I/O supports two high-speed, 16550 compatible serial communication ports (UARTs). Each UART includes a 16-byte send/receive FIFO, a programmable baud rate generator, complete modem control capability and a processor interrupt system. Both UARTs provide legacy speed with baud rate of up to 115.2 Kbps as well as an advanced speed with baud rates of 250 K, 500 K, or 1 Mb/s, which support higher speed modems.

The Super I/O provides functions that comply with ACPI (Advanced Configuration and Power Interface), which includes support of legacy and ACPI power management through an SMI or SCI function pin. It also features auto power management to reduce power consumption.

1-8 Advanced Power Management

The following advanced power management features are supported by this motherboard:

Intel® Intelligent Power Node Manager (NM) (Available when the NMView utility is installed in the system)

The Intel® Intelligent Power Node Manager (IPNM) provides your system with real-time thermal control and power management for maximum energy efficiency. Although IPNM Specification Version 1.5/2.0 is supported by the BMC (Baseboard Management Controller), your system must also have IPNM-compatible Manageability Engine (ME) firmware installed to use this feature.



Note: Support for IPNM Specification Version 1.5 or Version 2.0 depends on the power supply used in the system.

Management Engine (ME)

The Management Engine, which is an ARC controller embedded in the PCH, provides Server Platform Services (SPS) to your system. The services provided by SPS are different from those provided by the ME on client platforms.

Notes

Chapter 2

Installation

2-1 Standardized Warning Statements

The following statements are industry-standard warnings, provided to warn the user of situations which have the potential for bodily injury. Should you have questions or experience difficulty, contact Supermicro's Technical Support department for assistance. Only certified technicians should attempt to install or configure components. Read this section in its entirety before installing or configuring components in the Supermicro chassis.

Battery Handling



Warning!

There is a danger of explosion if the battery is replaced incorrectly. Replace the battery only with the same or equivalent type recommended by the manufacturer. Dispose of used batteries according to the manufacturer's instructions

電池の取り扱い

電池交換が正しく行われなかった場合、破裂の危険性があります。交換する電池はメーカーが推奨する型、または同等のものを使用下さい。使用済電池は製造元の指示に従って処分して下さい。

警告

電池更換不當會有爆炸危險。請只使用同類電池或制造商推薦的功能相當的電池更換原有電池。請按製造商的說明處理廢舊電池。

警告

電池更換不當會有爆炸危險。請使用製造商建議之相同或功能相當的電池更換原有電池。請按照製造商的說明指示處理廢棄舊電池。

Warnung

Bei Einsetzen einer falschen Batterie besteht Explosionsgefahr. Ersetzen Sie die Batterie nur durch den gleichen oder vom Hersteller empfohlenen Batterietyp. Entsorgen Sie die benutzten Batterien nach den Anweisungen des Herstellers.

Attention

Danger d'explosion si la pile n'est pas remplacée correctement. Ne la remplacer que par une pile de type semblable ou équivalent, recommandée par le fabricant. Jeter les piles usagées conformément aux instructions du fabricant.

¡Advertencia!

Existe peligro de explosión si la batería se reemplaza de manera incorrecta. Reemplazar la batería exclusivamente con el mismo tipo o el equivalente recomendado por el fabricante. Desechar las baterías gastadas según las instrucciones del fabricante.

אזהרה !

קיימת סכנת פיצוץ של הסוללה במידה והוחלפה בדרך לא תקינה. יש להחליף את הסוללה בסוג התואם מחברת יצרן מומלצת.

סילוק הסוללות המשומשות יש לבצע לפי הוראות היצרן.

هناك خطر من انفجار في حالة استبدال البطارية بطريقة غير صحيحة فعليك استبدال البطارية فقط بنفس النوع أو ما يعادلها كما أوصت به الشركة المصنعة تخلص من البطاريات المستعملة وفقا لتعليمات الشركة الصانعة

경고!

배터리가 올바르게 교체되지 않으면 폭발의 위험이 있습니다. 기존 배터리와 동일하거나 제조사에서 권장하는 동등한 종류의 배터리로만 교체해야 합니다. 제조사의 안내에 따라 사용된 배터리를 처리하여 주십시오.

Waarschuwing

Er is ontploffingsgevaar indien de batterij verkeerd vervangen wordt. Vervang de batterij slechts met hetzelfde of een equivalent type die door de fabrikant aanbevolen wordt. Gebruikte batterijen dienen overeenkomstig fabrieksvoorschriften afgevoerd te worden.

Product Disposal



Warning!

Ultimate disposal of this product should be handled according to all national laws and regulations.

製品の廃棄

この製品を廃棄処分する場合、国の関係する全ての法律・条例に従い処理する必要があります。

警告

本产品的废弃处理应根据所有国家的法律和规章进行。

警告

本產品的廢棄處理應根據所有國家的法律和規章進行。

Warnung

Die Entsorgung dieses Produkts sollte gemäß allen Bestimmungen und Gesetzen des Landes erfolgen.

¡Advertencia!

Al deshacerse por completo de este producto debe seguir todas las leyes y reglamentos nacionales.

Attention

La mise au rebut ou le recyclage de ce produit sont généralement soumis à des lois et/ou directives de respect de l'environnement. Renseignez-vous auprès de l'organisme compétent.

סילוק המוצר

אזהרה!

סילוק סופי של מוצר זה חייב להיות בהתאם להנחיות וחוקי המדינה.

عند التخلص النهائي من هذا المنتج ينبغي التعامل معه وفقا لجميع القوانين واللوائح الوطنية

경고!

이 제품은 해당 국가의 관련 법규 및 규정에 따라 폐기되어야 합니다.

Waarschuwing

De uiteindelijke verwijdering van dit product dient te geschieden in overeenstemming met alle nationale wetten en reglementen.

2-2 Static-Sensitive Devices

Electrostatic-Discharge (ESD) can damage electronic components. To avoid damaging your system board, it is important to handle it very carefully. The following measures are generally sufficient to protect your equipment from ESD.

Precautions

- Use a grounded wrist strap designed to prevent static discharge.
- Touch a grounded metal object before removing the board from the antistatic bag.
- Handle the board by its edges only; do not touch its components, peripheral chips, memory modules or gold contacts.
- When handling chips or modules, avoid touching their pins.
- Put the motherboard and peripherals back into their antistatic bags when not in use.
- For grounding purposes, make sure your computer chassis provides excellent conductivity between the power supply, the case, the mounting fasteners and the motherboard.
- Use only the correct type of onboard CMOS battery. Do not install the onboard battery upside down to avoid possible explosion.

Unpacking

The motherboard is shipped in antistatic packaging to avoid static damage. When unpacking the board, make sure that the person handling it is static protected.

2-3 Processor and Heatsink Installation

Warning: When handling the processor package, avoid placing direct pressure on the label area of the fan.



Important:

- Always connect the power cord last, and always remove it before adding, removing or changing any hardware components. Make sure that you install the processor into the CPU socket before you install the CPU heatsink.
- If you buy a CPU separately, make sure that you use an Intel-certified multi-directional heatsink only.
- Make sure to install the system board into the chassis before you install the CPU heatsink.
- When receiving a server board without a processor pre-installed, make sure that the plastic CPU socket cap is in place and none of the socket pins are bent; otherwise, contact your retailer immediately.
- Refer to the Supermicro website for updates on CPU support.

Installing the LGA1150 Processor

1. Gently press down the load plate handle and push it outward (to the right side) to unlock it.
2. Once the load plate handle is unlocked, gently lift the handle to open the load plate.

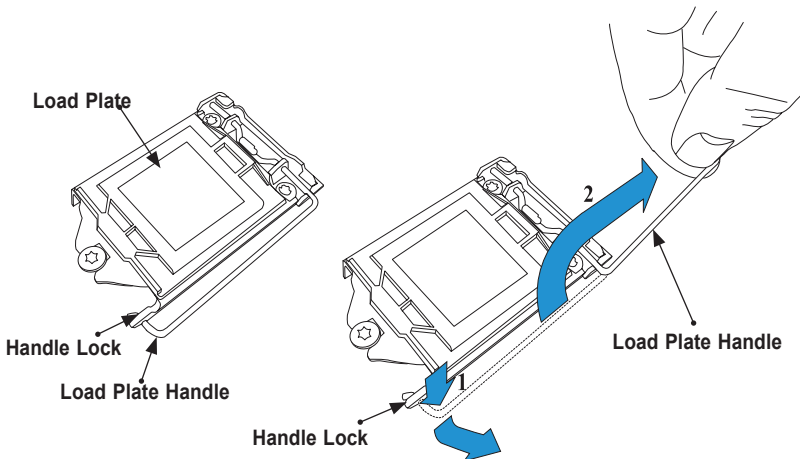

3. When the load plate is open, use your thumb and your index finger to hold the CPU at the north center edge and the south center edge of the CPU.

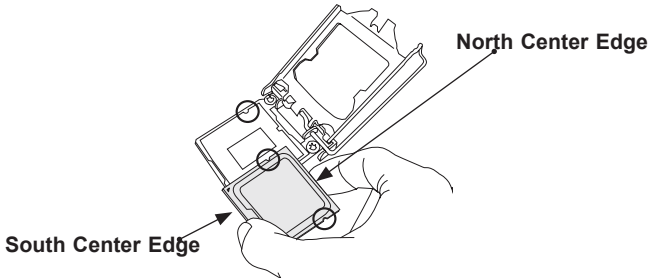

4. Align the CPU keys, which are the semicircular cutouts on the sides of the CPU (shown below), against the socket keys, the semicircular notches on the sides of the CPU socket. Align CPU Pin 1, the triangle at the bottom left of the CPU, against Pin 1 of the socket, the triangle marker at the bottom left of the CPU socket.

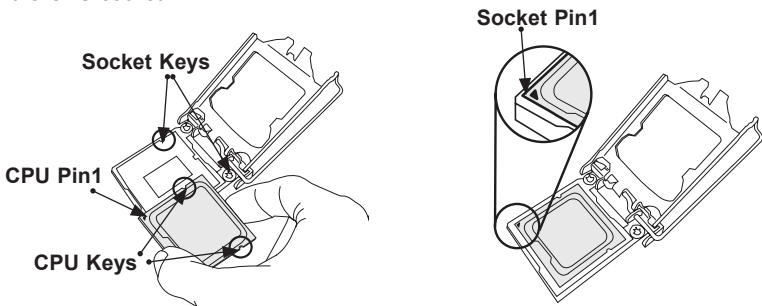

5. Once they are aligned, carefully lower the CPU straight down into the socket. (To avoid damaging the CPU or the socket, do not drop the CPU on the socket. Do not rub the CPU against the surface or against any pins of the socket.)
6. With the CPU seated inside the socket, inspect the four corners of the CPU to ensure that it is properly installed.

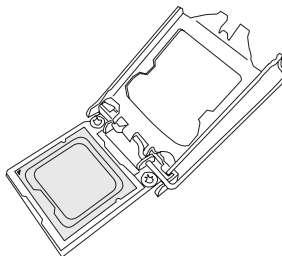

7. Once the CPU is properly installed, use your thumb to gently push the load plate handle down to the handle lock and lock it.

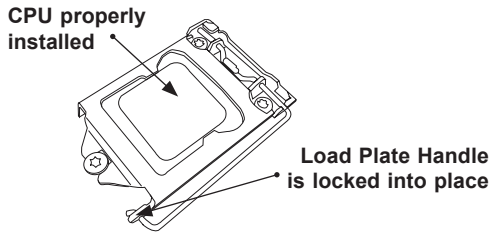

8. When the CPU is securely locked into the CPU socket, the plastic cap will be automatically loosened from the load plate. Use your thumb and index finger to remove the plastic cap from the socket.

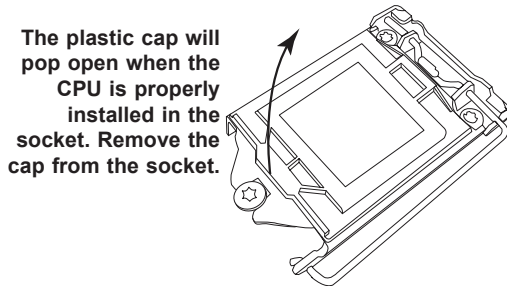

Warning: You can only install the CPU inside the socket only in one direction. Make sure that it is properly inserted into the CPU socket before closing the load plate. If it doesn't close properly, do not force it as it may damage your CPU. Instead, open the load plate again and double-check that the CPU is aligned properly.

Installing an Active CPU Heatsink with Fan

1. Locate the CPU Fan power connector on the motherboard. (Refer to the layout on the right for the CPU Fan location.)
2. Position the heatsink so that the heatsink fan wires are closest to the CPU fan power connector and are not interfered with other components.
3. Inspect the CPU Fan wires to make sure that the wires are routed through the bottom of the heatsink.
4. Remove the thin layer of the protective film from the heatsink.

Warning: CPU overheat may occur if the protective film is not removed from the heatsink.

5. Apply the proper amount of thermal grease on the CPU.



Note: If your heatsink came with a thermal pad, please ignore this step.

6. If necessary, rearrange the wires to make sure that the wires are not pinched between the heatsink and the CPU. Also make sure to keep clearance between the fan wires and the fins of the heatsink.

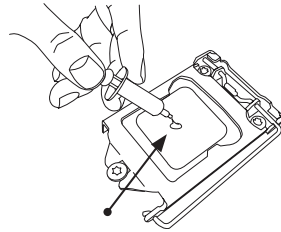

Thermal Grease

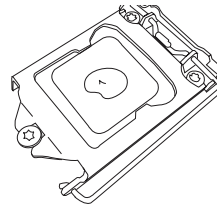

Heatsink Fins

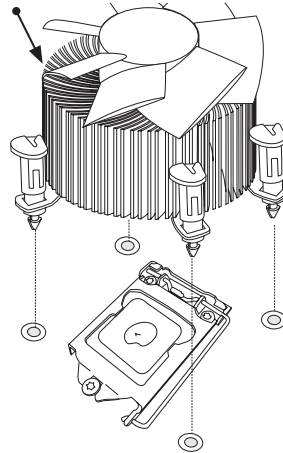

**Recommended Supermicro heatsink:
SNK-P0046A4 active heatsink**

7. Align the four heatsink fasteners with the mounting holes on the motherboard. Gently push the pairs of diagonal fasteners (#1 & #2, and #3 & #4) into the mounting holes until you hear a click. Also, make sure to orient each fastener so that the narrow end of the groove is pointing outward.
8. Repeat Step 7 to insert all four heatsink fasteners into the mounting holes.
9. Once all four fasteners are securely inserted into the mounting holes, and the heat-sink is properly installed on the motherboard, connect the heatsink fan wires to the CPU Fan connector.

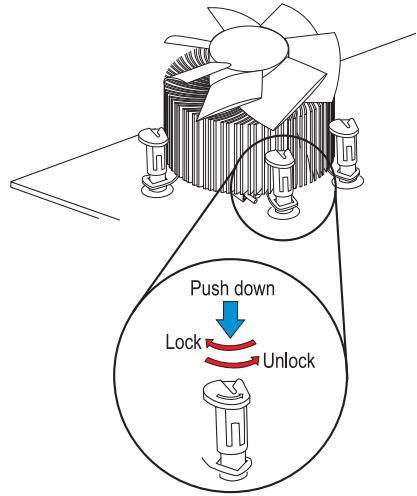

Removing the Heatsink

Warning: We do not recommend that the CPU or the heatsink be removed. However, if you do need to remove the heatsink, please follow the instructions below to remove the heatsink and to prevent damage done to the CPU or other components.

Active Heatsink Removal

1. Unplug the power cord from the power supply.
2. Disconnect the heatsink fan wires from the CPU fan header.
3. Use your finger tips to gently press on the fastener cap and turn it counterclockwise to make a 1/4 (90°) turn, and pull the fastener upward to loosen it.
4. Repeat Step 3 to loosen all fasteners from the mounting holes.
5. With all fasteners loosened, remove the heatsink from the CPU.

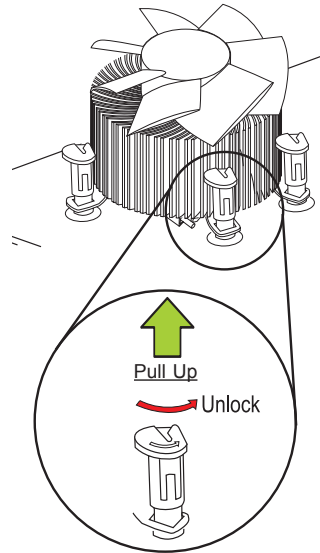
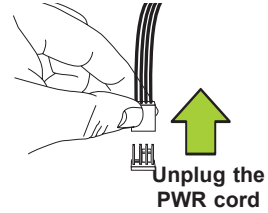

2-4 Installing DDR3 Memory



Note: Check the Supermicro website for recommended memory modules.

CAUTION

Exercise extreme care when installing or removing DIMM modules to prevent any possible damage.

DIMM Installation

1. Insert the desired number of DIMMs into the memory slots, starting with the blue slots DIMMA2, DIMMB2, then the black slots DIMMA1, and DIMMB1. For the system to work properly, please use the memory modules of the same type and speed in the same motherboard.
2. Push the release tabs outwards on both ends of the DIMM slot to unlock it.
3. Align the key of the DIMM module with the receptive point on the memory slot.
4. Align the notches on both ends of the module against the receptive points on the ends of the slot.
5. Use two thumbs together to press the notches on both ends of the module straight down into the slot until the module snaps into place.
6. Press the release tabs to the lock positions to secure the DIMM module into the slot.

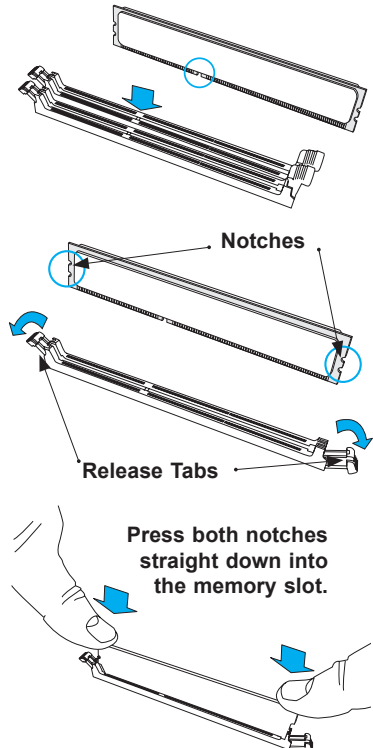
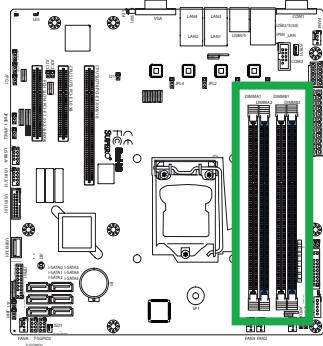

Removing Memory Modules

Reverse the steps above to remove the DIMM modules from the motherboard.

Memory Support

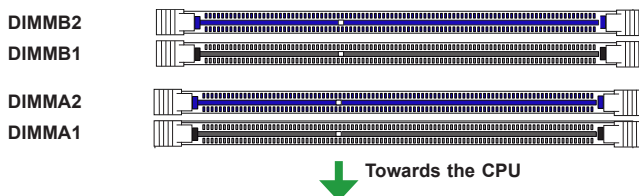

The X10SLM+/X10-SLL+ motherboard series supports up to 32GB of Unbuffered (UDIMM) ECC DDR3 1600/1333 MHz DIMMs in 4 memory slots. Populating these DIMM modules with a pair of memory modules of the same type and same size will result in interleaved memory, which will improve memory performance. Please refer to the table below:

Memory Population Guidelines

Please follow the table below when populating the motherboard.

DDR3 Unbuffered ECC (UDIMM) Memory				
DIMM Slots per Channel	DIMMs Populated per Channel	DIMM Type	POR Speeds	Ranks per DIMM (any combination)
2	1	Unbuffered DDR3	1333, 1600	Single Rank, Dual Rank
2	2	Unbuffered DDR3	1333, 1600	Single Rank, Dual Rank



Notes:

- Due to memory allocation to system devices, the amount of memory that remains available for operational use will be reduced when 4 GB of RAM is used. The reduction in memory availability is disproportional. See the following table for details.

Possible System Memory Allocation & Availability		
System Device	Size	Physical Memory Remaining (-Available) (4 GB Total System Memory)
Firmware Hub flash memory (System BIOS)	1 MB	3.99
Local APIC	4 KB	3.99
Area Reserved for the chipset	2 MB	3.99
I/O APIC (4 Kbytes)	4 KB	3.99
PCI Enumeration Area 1	256 MB	3.76
PCI Express (256 MB)	256 MB	3.51
PCI Enumeration Area 2 (if needed) -Aligned on 256-MB boundary-	512 MB	3.01
VGA Memory	16 MB	2.85
TSEG	1 MB	2.84
Memory available to OS and other applications		2.84

When installing memory modules, the DIMM slots should be populated in the following order: DIMMA2, DIMMB2, then DIMMA1, DIMMB1.

- Always use DDR3 DIMM modules of the same size, type and speed.
- Mixed DIMM speeds can be installed. However, all DIMMs will run at the speed of the slowest DIMM.

Recommended Population (Balanced)				
DIMMA2	DIMMB2	DIMMA1	DIMMB1	Total System Memory
2GB	2GB			4GB
2GB	2GB	2GB	2GB	8GB
4GB	4GB			8GB
4GB	4GB	4GB	4GB	16GB
8GB	8GB			16GB
8GB	8GB	8GB	8GB	32GB

2-5 Motherboard Installation

All motherboards have standard mounting holes to fit different types of chassis. Make sure that the locations of all the mounting holes for both motherboard and chassis match. Although a chassis may have both plastic and metal mounting fasteners, metal ones are highly recommended because they ground the motherboard to the chassis. Make sure that the metal standoffs click in or are screwed in tightly. Then use a screwdriver to secure the motherboard onto the motherboard tray.

Tools Needed

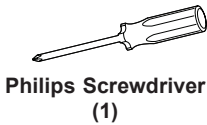

Location of Mounting Holes

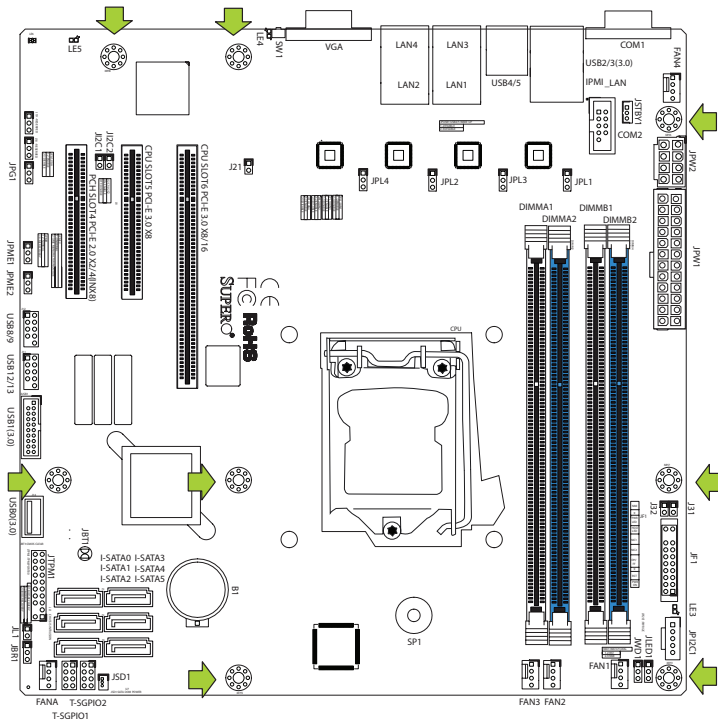

Caution: 1) To avoid damaging the motherboard and its components, please do not use a force greater than 8 lb/inch on each mounting screw during motherboard installation. 2) Some components are very close to the mounting holes. Please take precautionary measures to avoid damaging these components when installing the motherboard to the chassis.

Installing the Motherboard

1. Install the I/O shield into the back of the chassis.

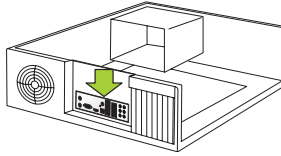

2. Locate the mounting holes on the motherboard. (See the previous page.)
3. Locate the matching mounting holes on the chassis. Align the mounting holes on the motherboard against the mounting holes on the chassis.
4. Install standoffs in the chassis as needed.

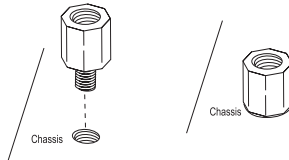

5. Install the motherboard into the chassis carefully to avoid damaging other motherboard components.
6. Using the Phillips screwdriver, insert a Phillips head #6 screw into a mounting hole on the motherboard and its matching mounting hole on the chassis.

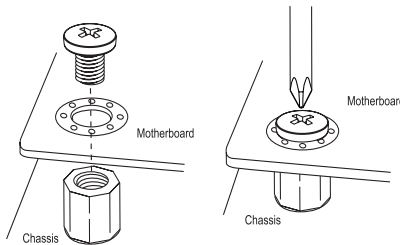

7. Repeat Step 5 to insert #6 screws into all mounting holes.
8. Make sure that the motherboard is securely placed in the chassis.



Note: Images displayed are for illustration only. Your chassis or system components may or may not look exactly the same as graphics shown in this manual.

2-6 Connectors/IO Ports

The I/O ports are color coded in conformance with the industry standards. See the figure below for the colors and locations of the various I/O ports.

Backplane I/O Panel

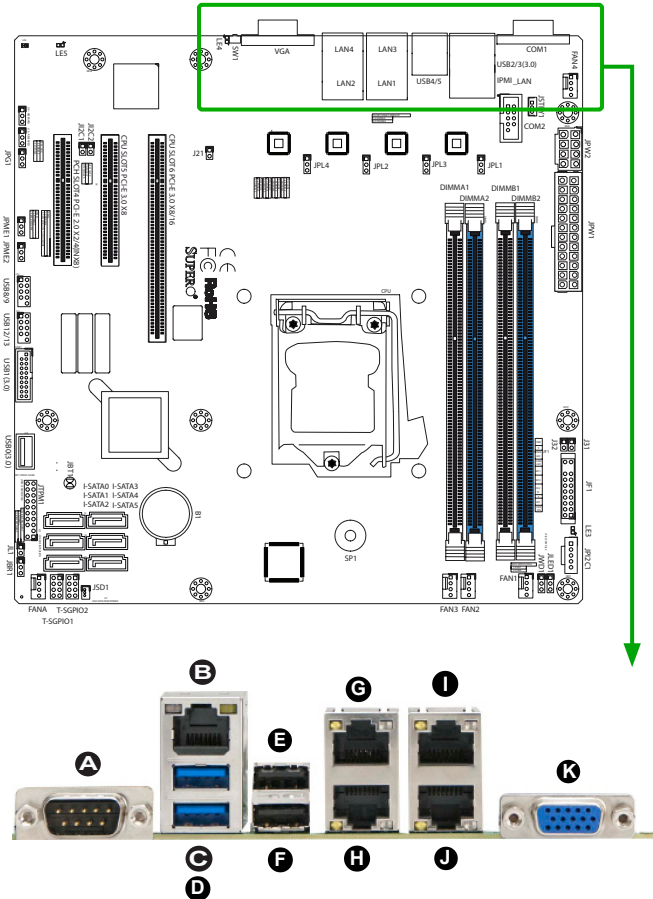

A. COM1	G. Gb LAN3**
B. IPMI Port	H. Gb LAN1
C. USB 2 (3.0)*	I. Gb LAN4**
D. USB 3 (3.0)*	J. Gb LAN2
E. USB 4 (2.0)	K. VGA Port
F. USB 5 (2.0)	

*USB 3.0 is supported on X10SLM+ series, while USB 2.0 is supported on the X10SLL+ series. ** Four (4) total LAN ports are supported on the X10SLM+-LN4F motherboard only.

Serial Ports

Two COM connections (COM1 & COM2) are located on the motherboard. COM1 is located on the I/O back panel. COM2 is located next to USB 2/3. See the table on the right for pin definitions.

Serial COM) Ports Pin Definitions			
Pin #	Definition	Pin #	Definition
1	DCD	6	DSR
2	RXD	7	RTS
3	TXD	8	CTS
4	DTR	9	RI
5	Ground	10	N/A

Video Connection

A Video (VGA) port is located next to LAN2 on the I/O back panel. Refer to the board layout below for the location.

A. COM1

B. COM2

C. VGA

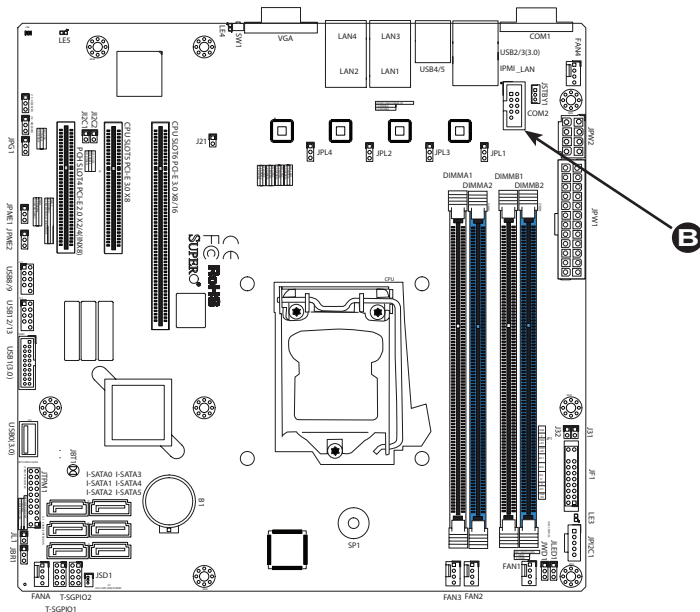
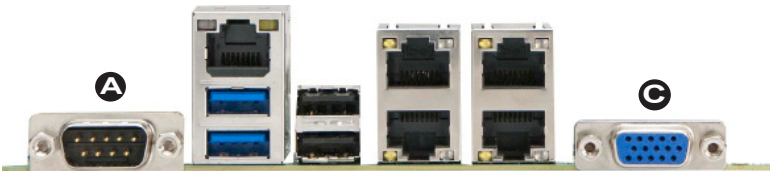

Universal Serial Bus (USB)

Four Universal Serial Bus 3.0 ports (USB 2, USB 3, USB 4, USB 5) are located on the I/O back panel. In addition, two USB 2.0 headers (four USB 2.0 connections: 8/9, 12/13), a Type A USB 3.0 header (USB 0), and a Vertical Type A USB 3.0 header (USB 1) are also located on the motherboard to provide front chassis access using USB cables (not included). See the tables below for pin definitions.

Front Panel USB (2.0) 8/9, 12/13 Pin Definitions			
Pin #	Definition	Pin #	Definition
1	+5V	2	+5V
3	USB_PN2	4	USB_PN3
5	USB_PP2	6	USB_PP3
7	Ground	8	Ground
9	Key	10	Ground

Front Panel USB (3.0) 0, 1, Backplane USB (3.0) 2, 3, 4, 5 Pin Definitions		
Pin#	Signal Name	Description
1	VBUS	Power
2	D-	USB 2.0 Differential Pair
3	D+	
4	Ground	Ground of PWR Return
5	StdA_SSRX-	SuperSpeed Receiver
6	StdA_SSRX+	Differential Pair
7	GND_DRAIN	Ground for Signal Return
8	StdA_SSTX-	SuperSpeed Transmitter
9	StdA_SSTX+	Differential Pair

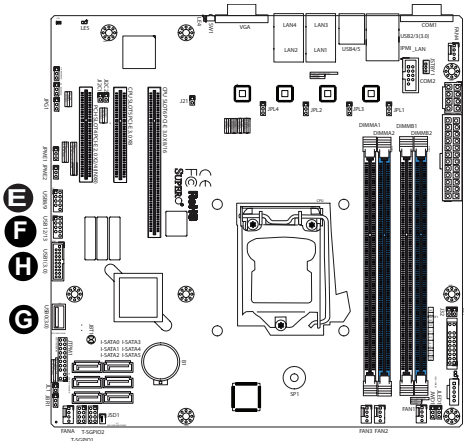
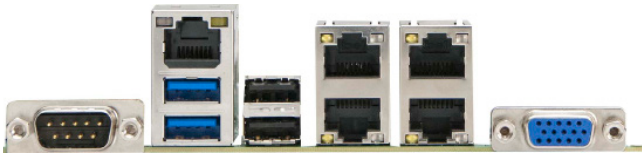

- A. Backpanel USB 2 (3.0)
- B. Backpanel USB 3 (3.0)
- C. Backpanel USB 4 (2.0)
- D. Backpanel USB 5 (2.0)
- E. Front USB 8/9 (2.0)
- F. Front USB 12/13 (2.0)
- G. Type A USB 0 (3.0)
- H. Vertical Type A USB 1 (3.0)

Ethernet Ports

Two Gigabit Ethernet ports (LAN1/ LAN2) are located next to the VGA Connector on the I/O back panel to provide network connections. These ports accept RJ45 type cables. Two additional ports are available on the X10SLM+-LN4F (LAN3/LAN4) for a total of four ports.

 **Note:** Please refer to the LED Indicator Section for LAN LED information.

LAN Ports Pin Definition			
Pin#	Definition		
1	P2V5SB	10	SGND
2	TD0+	11	Act LED
3	TD0-	12	P3V3SB
4	TD1+	13	Link 100 LED (Green, +3V3SB)
5	TD1-	14	Link 1000 LED (Yellow, +3V3SB)
6	TD2+	15	Ground
7	TD2-	16	Ground
8	TD3+	17	Ground
9	TD3-	88	Ground

(NC: No Connection)

A. LAN1

B. LAN2

C. LAN3

D. LAN4

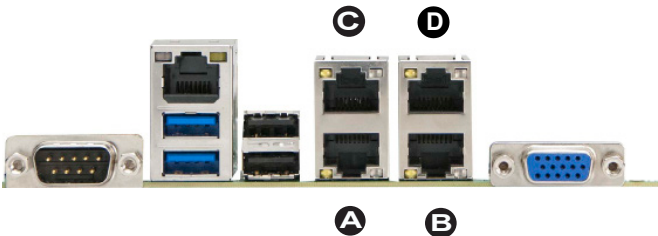
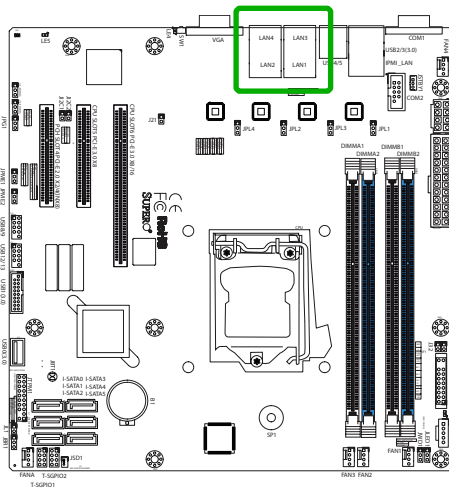

Unit Identifier Switch/UID LED Indicators

A Unit Identifier (UID) Switch and a UID LED Indicator (LE4) are located towards the back of the motherboard. The UID Switch is located next to the VGA port on the back panel. The rear UID LED (LE4) is located next to the UID Switch. When you press the UID switch, the rear UID LED (LE4) will turn on. Press the UID switch again to turn off LE4. The UID Indicator provides easy identification of a system unit that may be in need of service.



Note: UID can also be triggered via IPMI on the motherboard. For more information on IPMI, please refer to the IPMI User's Guide posted on our website at <http://www.supermicro.com>.

UID Switch	
Pin#	Definition
1	Ground
2	Ground
3	Button In
4	Ground

UID LED Status	
Color/State	Status
Blue: On	Unit Identifier

- A. UID Switch
- B. Rear UID LED
- C. Front UID LED

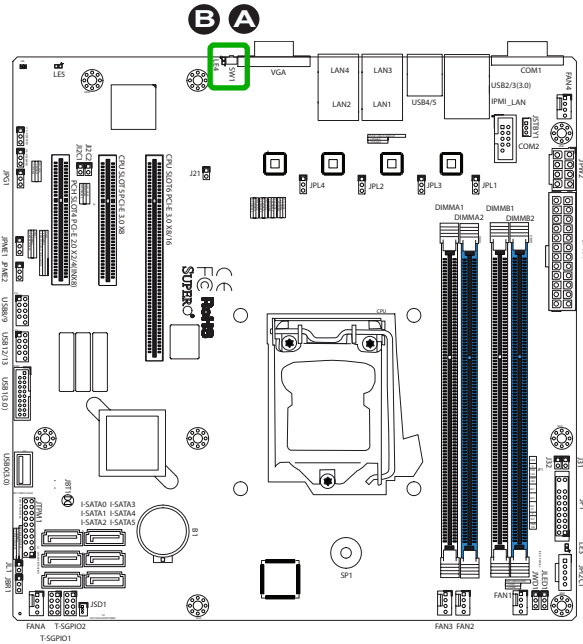

Front Control Panel

JF1 contains header pins for various buttons and indicators that are normally located on a control panel at the front of the chassis. These connectors are designed specifically for use with Supermicro chassis. See the figure below for the descriptions of the front control panel buttons and LED indicators. Refer to the following section for descriptions and pin definitions.

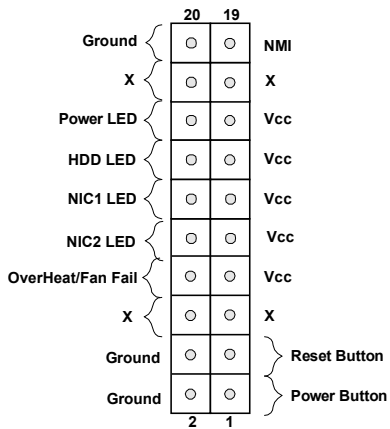
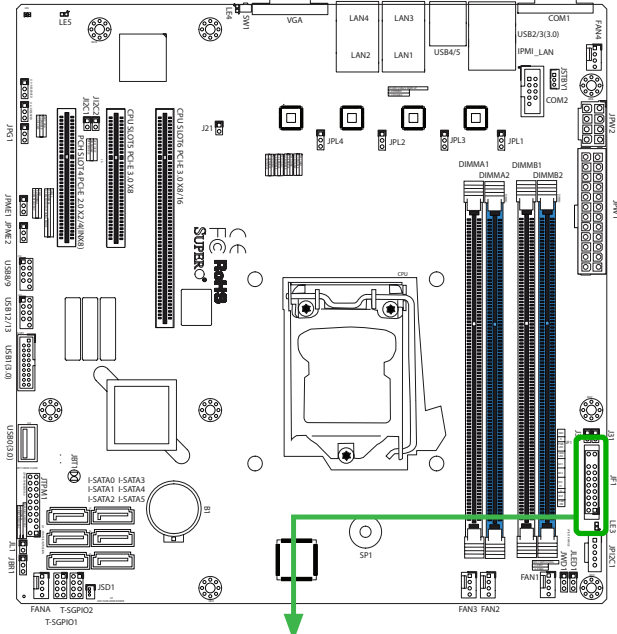

JF1 Header Pins

Front Control Panel Pin Definitions

NMI Button

The non-maskable interrupt button header is located on pins 19 and 20 of JF1. Refer to the table on the right for pin definitions.

NMI Button Pin Definitions (JF1)	
Pin#	Definition
19	Control
20	Ground

Power LED

The Power LED connection is located on pins 15 and 16 of JF1. Refer to the table on the right for pin definitions.

Power LED Pin Definitions (JF1)	
Pin#	Definition
15	3.3V
16	PWR LED

HDD LED

The HDD LED connection is located on pins 13 and 14 of JF1. Attach a cable here to indicate HDD activity. See the table on the right for pin definitions.

HDD LED Pin Definitions (JF1)	
Pin#	Definition
13	3.3V SB/UID_SW
14	HD Active

NIC1/NIC2 LEDs

The NIC (Network Interface Controller) LED connection for GLAN Port 1 is located on pins 11 and 12 of JF1, and the LED connection for GLAN Port 2 is on Pins 9 and 10. Attach the NIC LED cables to the LED indicators mentioned above to display network activity. Refer to the layout below for the locations of NIC LED indicators.

GLAN1/2 LED Pin Definitions (JF1)	
Pin#	Definition
9	NIC 2 Activity LED
10	NIC 2 Link LED
11	NIC 1 Activity LED
12	NIC 1 Link LED

- A. NMI
- B. PWR LED
- C. HDD LED
- D. NIC1 LED
- E. NIC2 LED

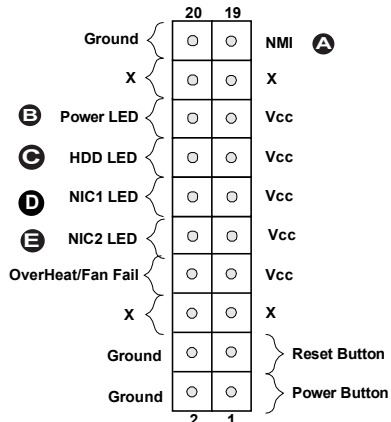

Overheat (OH)/Fan Fail/PWR Fail/UID LED

Connect an LED cable to pins 7 and 8 of Front Control Panel to use the Overheat/Fan Fail/Power Fail and UID LED connections. The Red LED on pin 7 provides warnings of over-heat, fan failure or power failure. The Blue LED on pin 8 works as the front panel UID LED indicator. The Red LED takes precedence over the Blue LED by default. Refer to the table on the right for pin definitions.

OH/Fan Fail/ PWR Fail/Blue_UID LED Pin Definitions (JF1)	
Pin#	Definition
7	Red_LED-Cathode/OH/Fan Fail/Power Fail5.5V.SB
8	Blue_UID LED

OH/Fan Fail/PWR Fail LED Status (Red LED)	
State	Definition
Off	Normal
On	Overheat
Flashing	Fan Fail

Reset Button

The Reset Button connection is located on pins 3 and 4 of JF1. Attach it to a hardware reset switch on the computer case. Refer to the table on the right for pin definitions.

Reset Button Pin Definitions (JF1)	
Pin#	Definition
3	Reset
4	Ground

Power Button

The Power Button connection is located on pins 1 and 2 of JF1. Momentarily contacting both pins will power on/off the system. This button can also be configured to function as a suspend button (with a setting in the BIOS - See Chapter 4). To turn off the power when the system is in suspend mode, press the button for 4 seconds or longer. Refer to the table on the right for pin definitions.

Power Button Pin Definitions (JF1)	
Pin#	Definition
1	Signal
2	Ground

A. OH/Fan Fail LED

B. Reset Button

C. Power Button

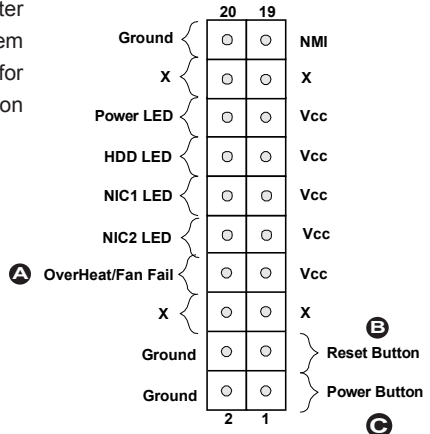

2-7 Connecting Cables

This section provides brief descriptions and pin-out definitions for onboard headers and connectors. Be sure to use the correct cable for each header or connector. For information on Backpanel USB and Front Panel USB ports, refer to page 2-21.

ATX Main PWR & CPU PWR Connectors (JPW1 & JPW2)

The 24-pin main power connector (JPW1) is used to provide power to the motherboard. The 8-pin CPU PWR connector (JPW2) is also required for the processor. These power connectors meet the SSI EPS 12V specification. See the table on the right for pin definitions.

12V 8-pin Power Connector Pin Definitions	
Pins	Definition
1 through 4	Ground
5 through 8	+12V

(Required)

ATX Power 24-pin Connector Pin Definitions (JPW1)			
Pin#	Definition	Pin #	Definition
13	+3.3V	1	+3.3V
14	-12V	2	+3.3V
15	COM	3	COM
16	PS_ON	4	+5V
17	COM	5	COM
18	COM	6	+5V
19	COM	7	COM
20	Res (NC)	8	PWR_OK
21	+5V	9	5VSB
22	+5V	10	+12V
23	+5V	11	+12V
24	COM	12	+3.3V

A. 24-Pin ATX Main PWR

B. 8-Pin PWR

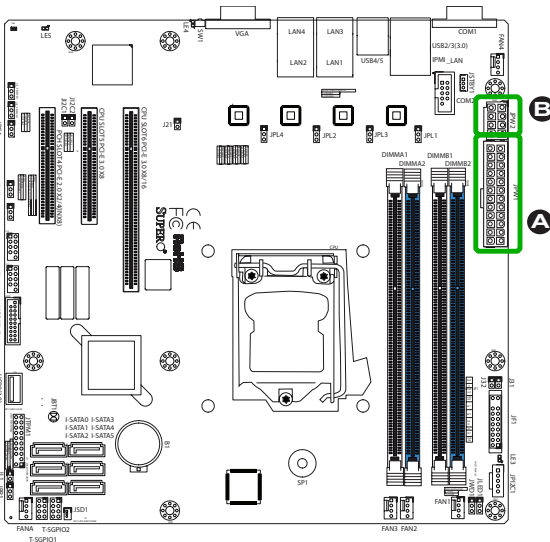

Fan Headers (Fan 1- Fan 4/Fan A)

The X10SLM+/X10SLL+ Motherboard Series has five fan headers (Fan 1-Fan 4, Fan A). These fans are 4-pin fan headers. Although pins 1-3 of the fan headers are backward compatible with the traditional 3-pin fans, we recommend that 4-pin fans be used to take advantage of the fan speed control via IPMI interface. This allows the fan speeds to be automatically adjusted based on the temperatures of the CPU or the motherboard. Refer to the table on the right for pin definitions.

Fan Header Pin Definitions	
Pin#	Definition
1	Ground (Black)
2	2.5A/+12V (Red)
3	Tachometer
4	PWM_Control

Chassis Intrusion Pin Definitions (JL1)	
Pin#	Definition
1	Intrusion Input
2	Ground

Chassis Intrusion (JL1)

A Chassis Intrusion header is located at JL1 on the motherboard. Attach the appropriate cable from the chassis to inform you of a chassis intrusion when the chassis is opened.

A. Fan 1 (CPU Fan)

B. Fan 2

C. Fan 3

D. Fan 4

E. Fan A

F. Chassis Intrusion

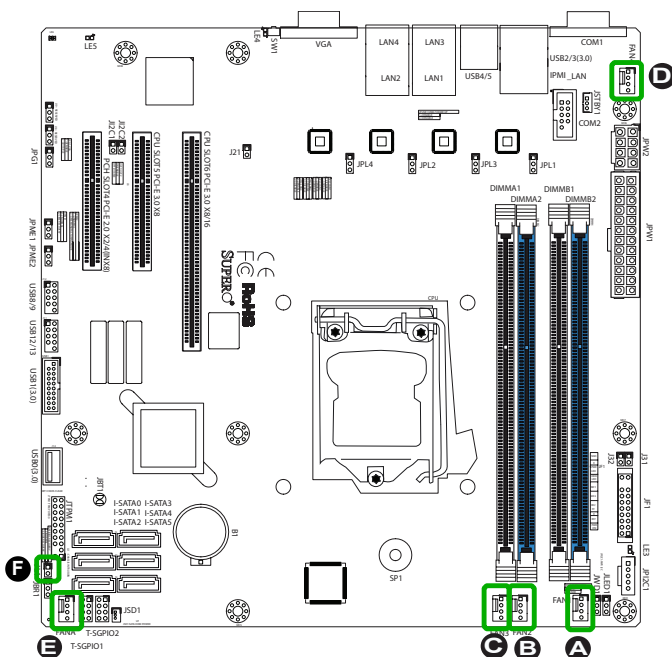

Internal Buzzer (SP1)

The Internal Buzzer or speaker (SPKR1) can be used to provide audible indications for various beep codes. See the table on the right for pin definitions.

Internal Buzzer Pin Definition		
Pin#	Definitions	
Pin 1	Pos. (+)	Beep In
Pin 2	Neg. (-)	Alarm Speaker

Onboard Power LED (JLED1)

An onboard Power LED header is located at JLED1. This Power LED header is connected to Front Control Panel located at JF1 to indicate the status of system power. See the table on the right for pin definitions.

Onboard PWR LED Pin Definitions	
Pin#	Definition
1	VCC
2	No Connection
3	Connection to PWR LED in JF1

A. Internal Buzzer

B. Power LED

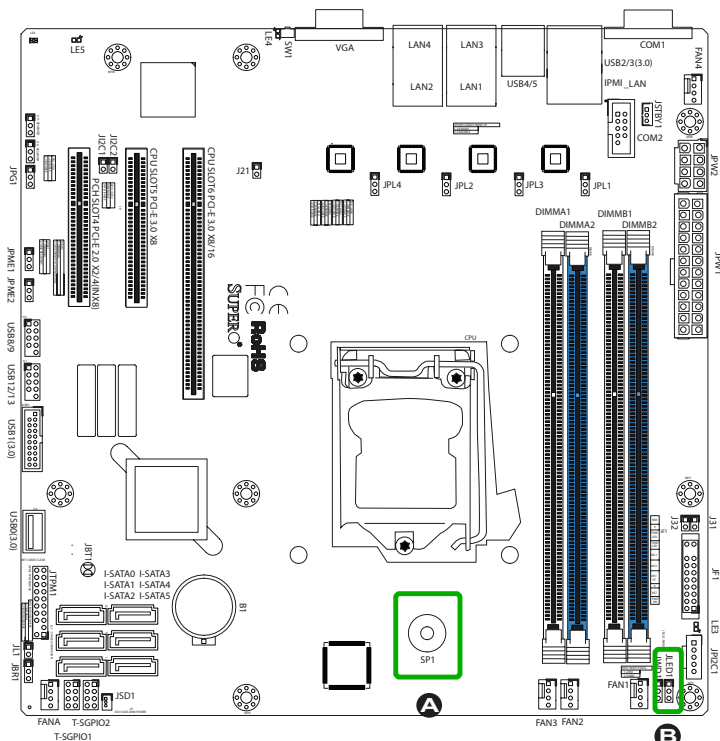

DOM PWR Connector (JSD1)

The Disk-On-Module (DOM) power connector, located at JSD1, provides 5V (Gen1/Gen) power to a solid state DOM storage device connected to one of the SATA ports. See the table on the right for pin definitions.

DOM PWR Pin Definitions	
Pin#	Definition
1	5V
2	Ground
3	Ground

Standby Power Header

The Standby Power header is located at STBY1 on the motherboard. See the table on the right for pin definitions.

Standby Power Pin Definitions	
Pin#	Definition
1	+5V Standby
2	Ground
3	No Connection

A. DOM PWR

B. Standby PWR

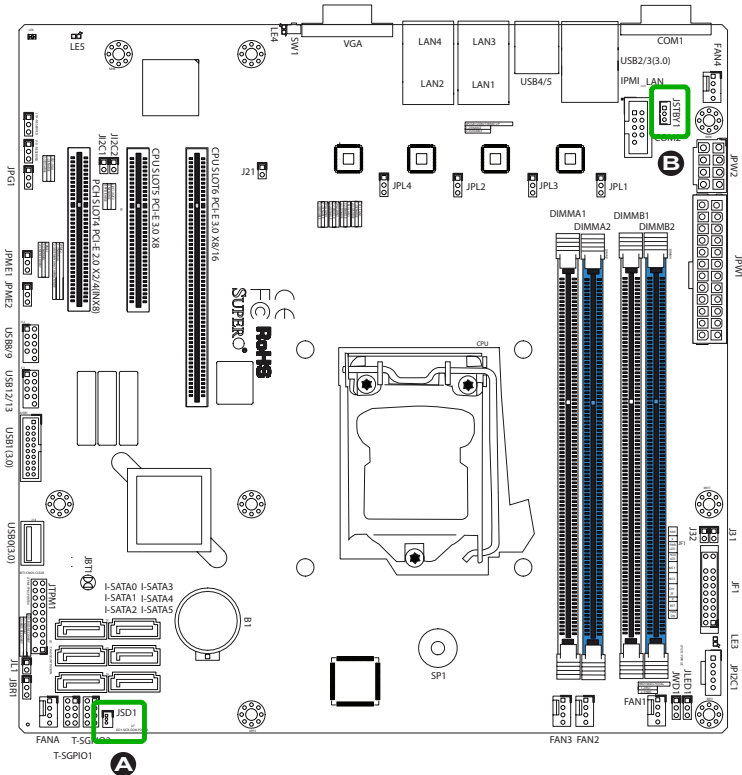

T-SGPIO 1/2 Headers

The Serial General Purpose Input/Output (SGPIO) is a bus used between the hard drive controller and a backplane. There are two T-SGPIO headers on this motherboard. See the table on the right for pin definitions.

T-SGPIO Pin Definitions			
Pin#	Definition	Pin	Definition
1	NC	2	NC
3	Ground	4	Data
5	Load	6	Ground
7	Clock	8	NC

TPM Header/Port 80 Header

A Trusted Platform Module/Port 80 header is located at JTPM1 to provide TPM support and Port 80 connection. Use this header to enhance system performance and data security. See the table on the right for pin definitions.

TPM/Port 80 Header Pin Definitions			
Pin #	Definition	Pin #	Definition
1	LCLK	2	GND
3	LFRAME#	4	<(KEY)>
5	LRESET#	6	+5V (X)
7	LAD 3	8	LAD 2
9	+3.3V	10	LAD1
11	LAD0	12	GND
13	SMB_CLK4	14	SMB_DAT4
15	+3V_DUAL	16	SERRIRQ
17	GND	18	CLKRUN# (X)
19	LPCPD#	20	LDRQ# (X)

A.T-SGPIO 1

B.T-SGPIO 2

C.JTPM1

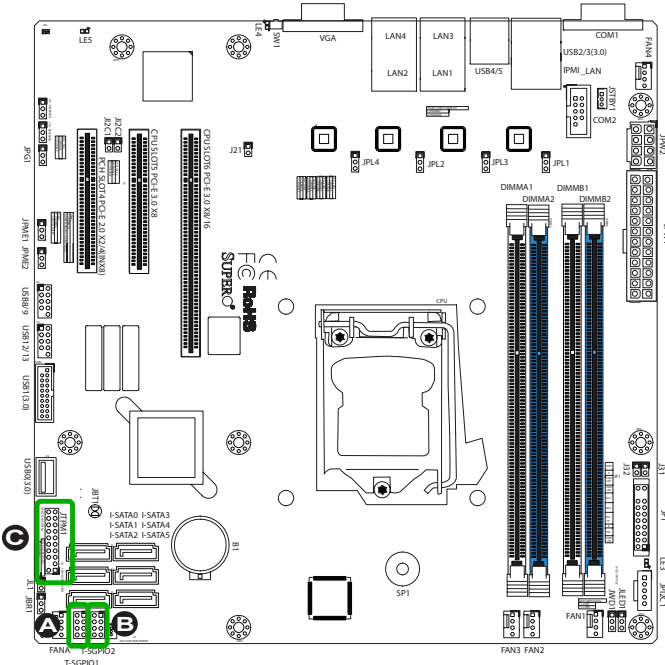

Power SMB (I²C) Connector

Power System Management Bus (I²C) Connector (JPI²C1) monitors power supply, fan and system temperatures. See the table on the right for pin definitions.

PWR SMB Pin Definitions	
Pin#	Definition
1	Clock
2	Data
3	PWR Fail
4	Ground
5	+3.3V

LAN3 / LAN4 LED Header

There is one LED header each for LAN3 and LAN4. Attach an external LED to these headers to display LAN activity for these ports. These are supported on the X10SLM+-LN4F only.

- A. PWR SMB
- B. LAN3 LED Header
- C. LAN4 LED Header

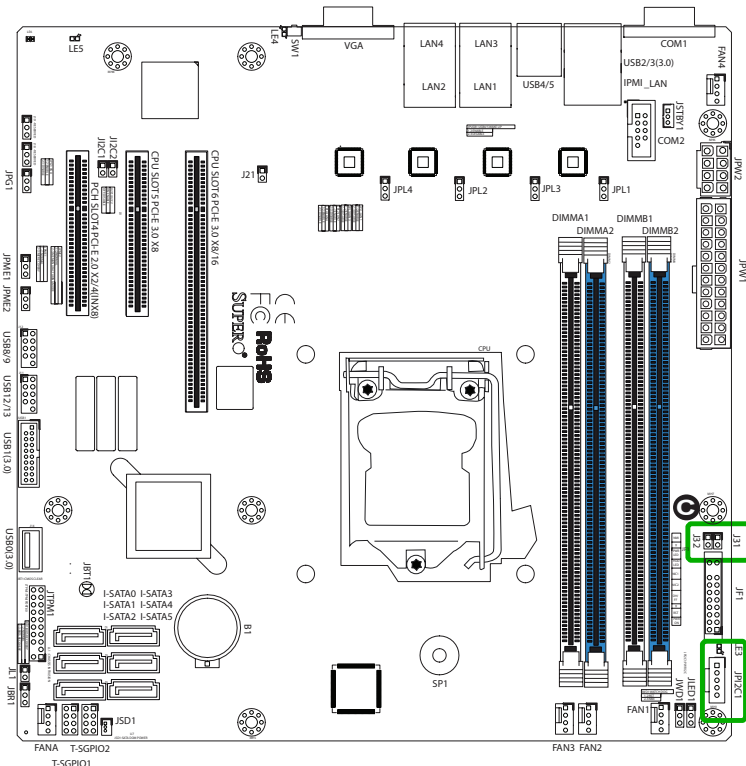

2-8 Jumper Settings

Explanation of Jumpers

To modify the operation of the motherboard, jumpers can be used to choose between optional settings. Jumpers create shorts between two pins to change the function of the connector. Pin 1 is identified with a square solder pad on the printed circuit board.



Note: On two-pin jumpers, "Closed" means the jumper is on, and "Open" means the jumper is off the pins.

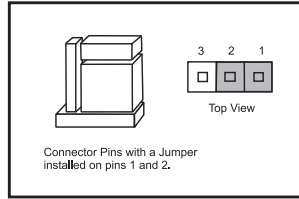
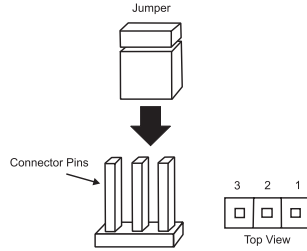

GLAN Enable/Disable

Jumpers JPL1/JPL2 will enable or disable LAN ports 1/2 on the motherboard. On the X10SLM+-LN4F, JPL3 and JPL4 will enable or disable LAN ports 3/4. See the table on the right for jumper settings. The default setting is enabled.

GLAN Enable Jumper Settings	
Pin#	Definition
1-2	Enabled (default)
2-3	Disabled

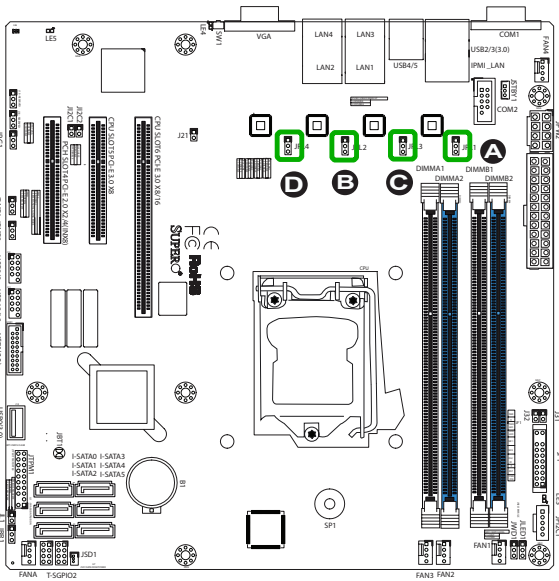

- A. JPL1: LAN1 Enable
- B. JPL2: LAN2 Enable
- C. JPL3: LAN3 Enable
- D. JPL4: LAN4 Enable

Clear CMOS (JBT1)

JBT1 is used to clear the saved system setup configuration stored in the CMOS chip. To clear the contents of the CMOS, completely shut down the system, remove the AC power cord and then short JBT1 with a jumper. Remove the jumper before powering on the system again. This will erase all user settings and revert everything to their factory-set defaults.

PCI Slot SMB Enable (I²C1/I²C2)

Use Jumpers I²C1/I²C2 to enable PCI SMB (System Management Bus) support to improve system management for the PCI slots. See the table on the right for jumper settings.

PCI Slot_SMB Enable Jumper Settings	
Jumper Setting	Definition
Short	Enabled
Open (Default)	Disabled

A. Clear CMOS

B. JI²C1

C. JI²C2

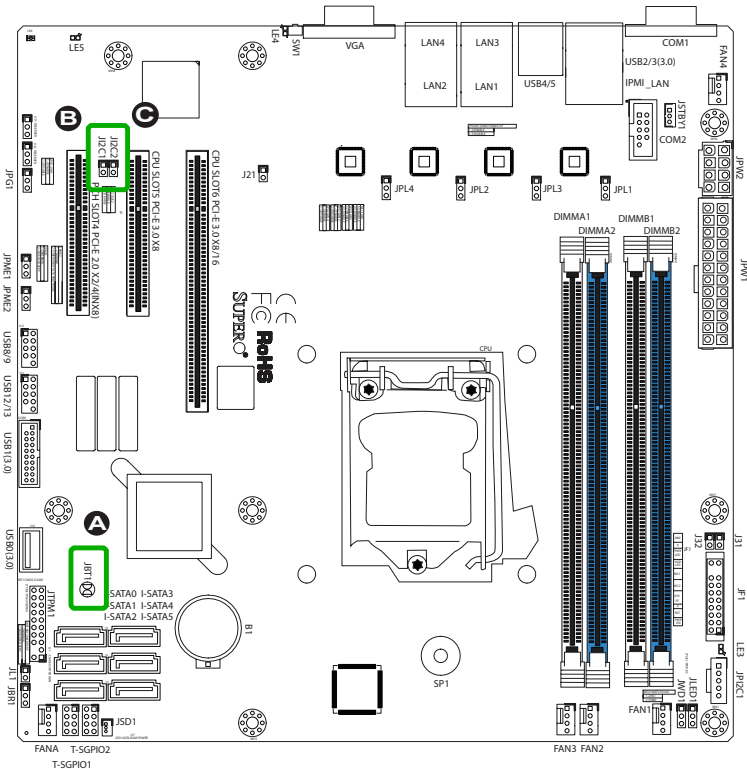

Watch Dog Enable/Disable

Watch Dog (JWD1) is a system monitor that can reboot the system when a software application hangs. Close pins 1-2 to reset the system if an application hangs. Close pins 2-3 to generate a non-maskable interrupt signal for the application that hangs. See the table on the right for jumper settings. Watch Dog must also be enabled in the BIOS.

Watch Dog Jumper Settings	
Jumper Setting	Definition
Pins 1-2	Reset (default)
Pins 2-3	NMI
Open	Disabled

VGA Enable

Jumper JPG1 allows the user to enable the onboard VGA connector. The default setting is 1-2 to enable the connection. See the table on the right for jumper settings.

VGA Enable Jumper Settings	
Jumper Setting	Definition
1-2	Enabled (Default)
2-3	Disabled

A. Watch Dog Enable

B. VGA Enable

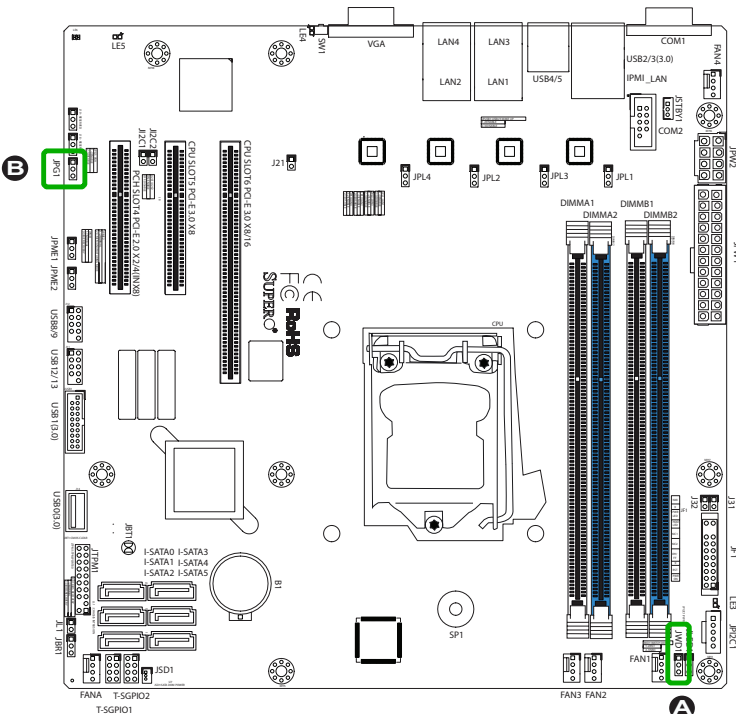

Management Engine (ME) Recovery

Set jumper JPME1 to select ME Firmware Recovery mode, which will limit system resource for essential function use only without putting restrictions on power use. In the single operation mode, online upgrade will be available via Recovery mode. See the table on the right for pin definitions.

ME Recovery Jumper Settings	
Jumper Setting	Definition
1-2	Normal (Default)
2-3	ME Recovery

Manufacture (ME) Mode Select

Close this jumper JPME2 to bypass SPI flash security and force the system to use the Manufacture Mode which will allow the user to flash the system firmware from a host server to modify system settings. See the table on the right for jumper settings.

ME Mode Select Jumper Settings	
Jumper Setting	Definition
1-2	Normal (Default)
2-3	Manufacture Mode

[A. ME Recovery](#)

[B. ME Mode Select](#)

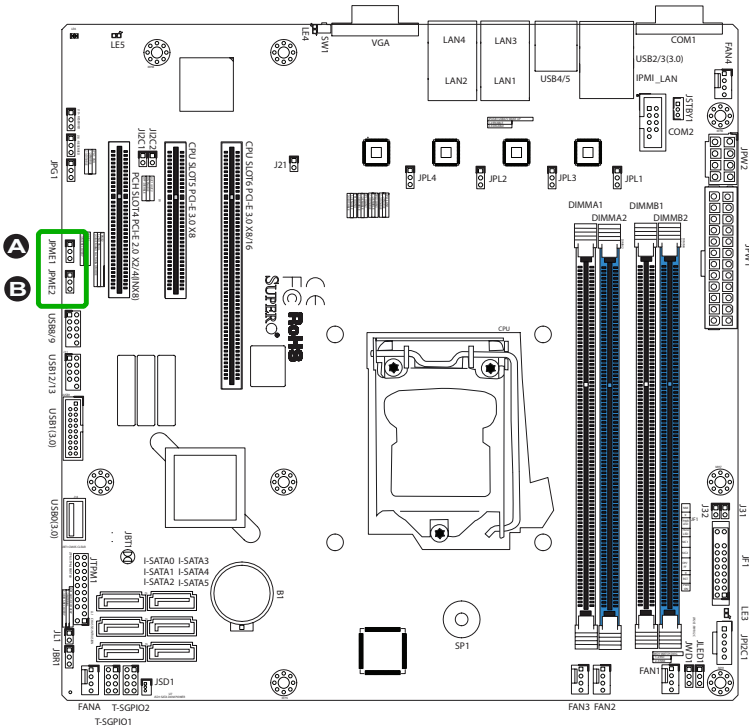

BIOS Recovery Enable

Close pins 1 and 2 of jumper JBR1 for BIOS recovery. The default setting is on pins 2 and 3 for normal operation. See the table on the right for jumper settings.

BIOS Recovery Jumper Settings	
Jumper Setting	Definition
Pins 1-2	BIOS Recovery
Pins 2-3	Normal

A. BIOS Recovery

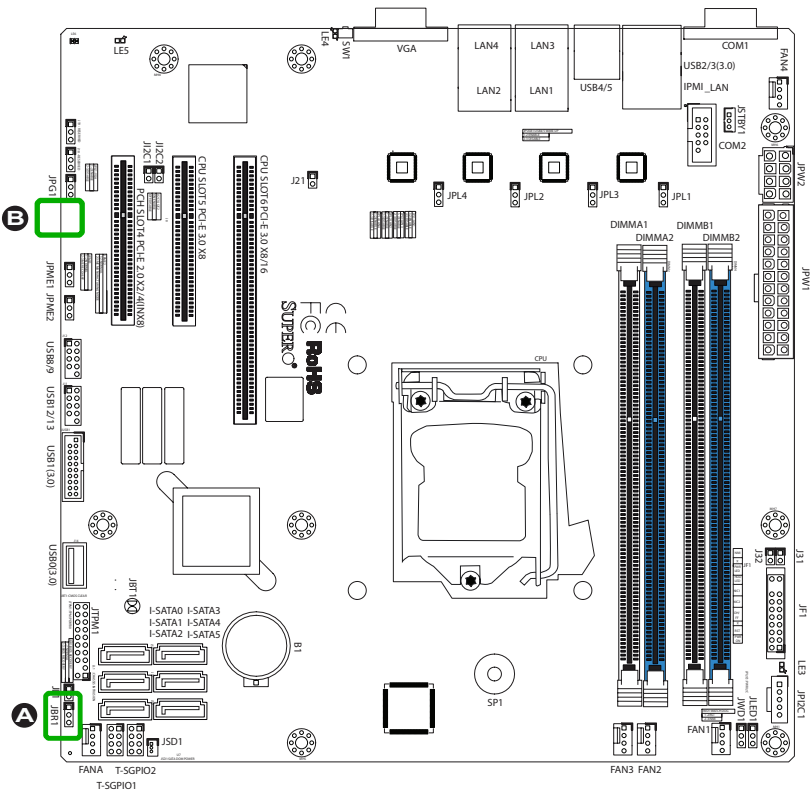

LAN Firmware Upgrade

To upgrade the LAN firmware installed on the motherboard, activate this jumper to allow the firmware to be erased and written over by the process. **Warning:** This process is irreversible.

LAN Firmware Upgrade Jumper Settings	
Jumper Setting	Definition
Shorted	Enabled
Open	Normal (Default)

A. LAN Firmware Recovery

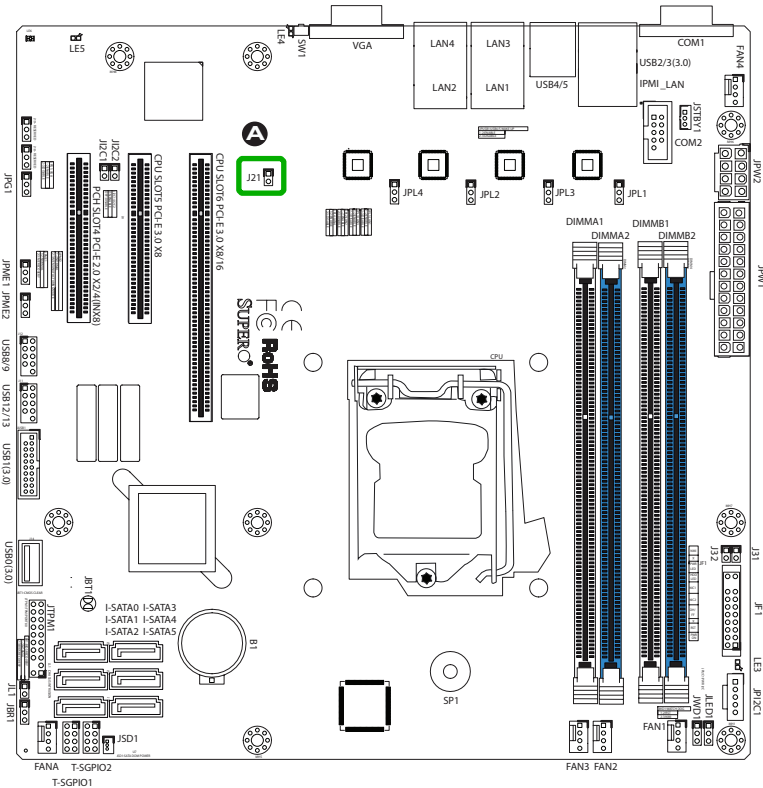

2-9 Onboard Indicators

LAN1/LAN2 LEDs

Two LAN ports (LAN1/LAN2) are located on the I/O back panel of the motherboard. Each Ethernet LAN port has two LEDs. The yellow LED indicates activity, while the Link LED may be green, amber, or off to indicate the speed of the connections. See the tables at right for more information. On the X10SLM+-LN4F, there is an additional two LAN ports (LAN3/LAN4).

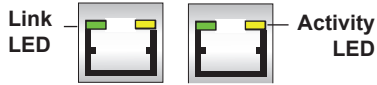

LAN 1/2/3/4 Activity Indicator LED Settings		
Color	Status	Definition
Yellow	Flashing	Active

LAN Ports 1/2/3/4 Link Indicator LED Settings	
LED Color	Definition
Off	No Connection or 10 Mbps
Amber	1 Gbps
Green	100 Mbps

Dedicated IPMI LAN LEDs

A dedicated IPMI LAN port is also located on the I/O back panel. The amber LED on the right indicates connection and activity, while the green LED on the left indicates the speed of the connection. See the table on the right.

IPMI LAN



IPMI LAN Link Speed LED (Left) & Connection Activity LED (Right)		
LED	Color/State	Definition
Off	Off	No Connection
Activity	Amber: Blinking	Active
Speed	Orange	1 Gbps
Speed	Green	100 Mbps

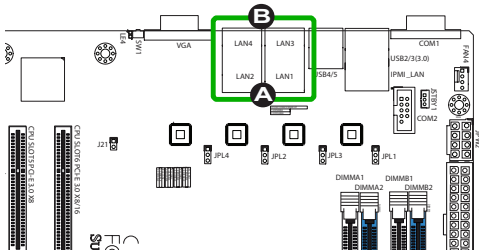

A. LAN1/2 LEDs

B. LAN3/4 LEDs

C. IPMI LAN LEDs

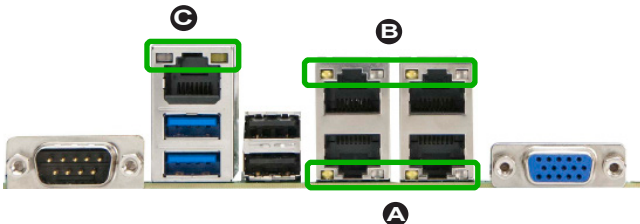

2-10 SATA Connections

SATA 3.0 Connections

Six Serial ATA (SATA) connectors (I-SATA0-5) are located on the X10SLM+/X10SLL+ Motherboard Series. These SATA ports are supported by the Intel® C224/C222/C220 Express PCH chip. The X10SLL+ series supports two (2) SATA 3.0 and four (4) SATA 2.0 ports, while the X10SLM+ series supports four (4) SATA 3.0 and two (2) SATA 2.0 ports. See the tables below for port information and pin definitions.

X10SLM+ Series SATA Connector Types	
Port#	Connection Type
I-SATA 0-3	SATA 3.0/6 Gb/s (RAID 0, 1, 10, 5)
I-SATA 4-5	SATA 2.0/3 Gb/s (RAID 0, 1)
Supported by	Intel C224 Express PCH

X10SLL+ Series SATA Connector Types	
Port#	Connection Type
I-SATA 0-1	SATA 3.0/6 Gb/s (RAID 0, 1)
I-SATA 2-5	SATA 2.0/3 Gb/s (RAID 0, 1, 10, 5)
Supported by	Intel C222 Express PCH

SATA 2.0/3.0 Connectors Pin Definitions	
Pin#	Signal
1	Ground
2	SATA_TXP
3	SATA_TXN
4	Ground
5	SATA_RXN
6	SATA_RXP
7	Ground

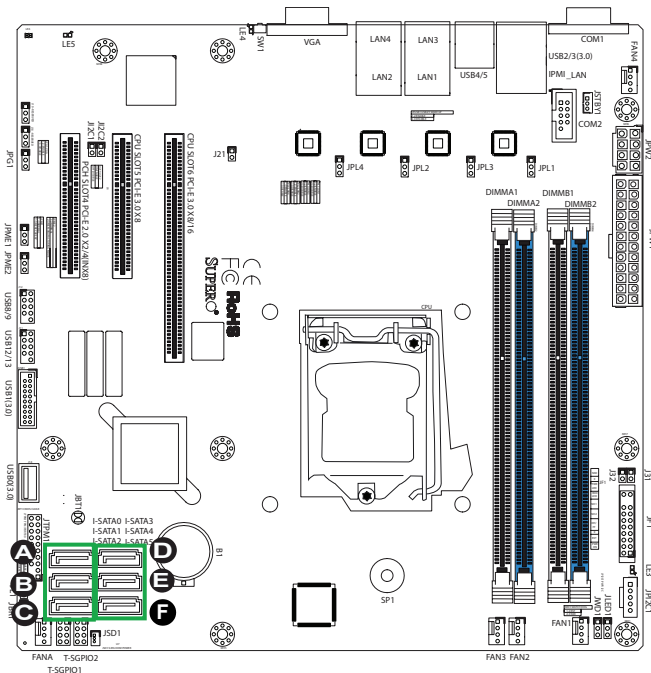

- A. I-SATA0
- B. I-SATA1
- C. I-SATA2
- D. I-SATA3
- E. I-SATA4
- F. I-SATA5

Chapter 3

Troubleshooting

3-1 Troubleshooting Procedures

Use the following procedures to troubleshoot your system. If you have followed all of the procedures below and still need assistance, refer to the 'Technical Support Procedures' and/or 'Returning Merchandise for Service' section(s) in this chapter. Always disconnect the AC power cord before adding, changing or installing any hardware components.

Before Power On

1. Make sure that the Onboard Power LED is not on. (**Note:** If it is on, the onboard power is on. Be sure to unplug the power cable before installing or removing the components.)
2. Make sure that there are no short circuits between the motherboard and chassis.
3. Disconnect all ribbon/wire cables from the motherboard, including those for the keyboard and mouse. Also, be sure to remove all add-on cards.
4. Install a CPU and heatsink (-be sure that it is fully seated) and then connect the chassis speaker and the power LED to the motherboard. Check all jumper settings as well.

No Power

1. Make sure that there are no short circuits between the motherboard and chassis.
2. Make sure that all jumpers are set to their default positions.
3. Check if the 115V/230V switch on the power supply is properly set.
4. Turn the power switch on and off to test the system.
5. The battery on your motherboard may be old. Check to make sure that it still supplies ~3VDC. If it does not, replace it with a new one.

No Video

1. If the power is on, but you have no video--in this case, you will need to remove all the add-on cards and cables first.
2. Use the speaker to determine if any beep codes exist. (Refer to Appendix A for details on beep codes.)
3. Remove all memory modules and turn on the system. (If the alarm is on, check the specifications of memory modules, reset the memory or try a different one.)

Memory Errors

1. Make sure that the DIMM modules are properly installed and fully seated in the slots.
2. You should be using unbuffered ECC DDR3 (1.5V) 1600/1333 MHz memory recommended by the manufacturer. Also, it is recommended that you use the memory modules of the same type and speed for all DIMMs in the system. Do not use memory modules of different sizes, different speeds and different types on the same motherboard.
3. Check for bad DIMM modules or slots by swapping modules between slots to see if you can locate the faulty ones.
4. Check the switch of 115V/230V power supply.

Losing the System's Setup Configuration

1. Please be sure to use a high quality power supply. A poor quality power supply may cause the system to lose CMOS setup information. Refer to Section 1-5 for details on recommended power supplies.
2. The battery on your motherboard may be old. Check to verify that it still supplies ~3VDC. If it does not, replace it with a new one.
3. If the above steps do not fix the Setup Configuration problem, contact your vendor for repairs.

3-2 Technical Support Procedures

Before contacting Technical Support, please make sure that you have followed all the steps listed below. Also, Note that as a motherboard manufacturer, Supermicro does not sell directly to end users, so it is best to first check with your distributor or reseller for troubleshooting services. They should know of any possible problem(s) with the specific system configuration that was sold to you.

1. Please go through the 'Troubleshooting Procedures' and 'Frequently Asked Question' (FAQ) sections in this chapter or see the FAQs on our website (<http://www.supermicro.com/support/faqs/>) before contacting Technical Support.
2. BIOS upgrades can be downloaded from our website at (<http://www.supermicro.com/support/bios/>).



Note: Not all BIOS can be flashed. Some cannot be flashed; it depends on the boot block code of the BIOS.

3. If you've followed the instructions above to troubleshoot your system, and still cannot resolve the problem, then contact Supermicro's technical support and provide them with the following information:
 - Motherboard model and PCB revision number
 - BIOS release date/version (this can be seen on the initial display when your system first boots up)
 - System configuration
 - An example of a Technical Support form is on our website at (<http://www.supermicro.com/support/contact.cfm>).
4. Distributors: For immediate assistance, please have your account number ready when placing a call to our technical support department. We can be reached by e-mail at support@supermicro.com, by phone at: (408) 503-8000, option 2, or by fax at (408)503-8019.

3-3 Frequently Asked Questions

Question: What type of memory does my motherboard support?

Answer: The X10SLM+/X10SSL+ Motherboard Series supports up to 32GB of un-buffered ECC DDR3/DDR3L 1600/1333 MHz (1.5V/1.35V) memory modules. See Section 2-4 for details on installing memory.

Question: How do I update my BIOS?

Answer: We do NOT recommend that you upgrade your BIOS if you are not experiencing any problems with your system. Updated BIOS files are located on our website at <http://www.supermicro.com/support/bios/>. Please check our BIOS warning message and the information on how to update your BIOS on our web site. Select your motherboard model and download the BIOS ROM file to your computer. Also, check the current BIOS revision to make sure that it is newer than your BIOS before downloading. You may choose the zip file or the .exe file. If you choose the zipped BIOS file, please unzip the BIOS file onto a bootable device or a USB pen/thumb drive. To flash the BIOS, run the batch file named "ami.bat" with the new BIOS ROM file from your bootable device or USB pen/thumb drive. Use the following format:

```
F:\> ami.bat BIOS-ROM-filename.xxx <Enter>
```



Note: Always use the file named "ami.bat" to update the BIOS, and insert a space between "ami.bat" and the filename. The BIOS-ROM-filename will bear the motherboard name (i.e., X10SLM+-F) and build version as the extension. For example, "X10SLM+-F.115". When completed, your system will automatically reboot.

If you choose the .exe file, please run the .exe file under Windows to create the BIOS flash floppy disk. Insert the floppy disk into the system you wish to flash the BIOS. Then, boot the system to the floppy disk. The BIOS utility will automatically flash the BIOS without any prompts. Please note that this process may take a few minutes to complete. Do not be concerned if the screen is paused for a few minutes.

When the BIOS flashing screen is completed, the system will reboot and will show "Press F1 or F2". At this point, you will need to load the BIOS defaults. Press <F1> to go to the BIOS setup screen, and press <F9> to load the default settings. Next, press <F10> to save and exit. The system will then reboot.

Warning: Do not shut down or reset the system while updating the BIOS to prevent possible system boot failure!



Important: The SPI BIOS chip installed on this motherboard is not removable. To repair or replace a damaged BIOS chip, please send your motherboard to RMA at Supermicro for service.

Question: I think my BIOS is corrupted. How can I recover my BIOS?

Answer: Please see Appendix C-BIOS Recovery for detailed instructions.

Question: Why do I get an error message "IASTOR.SYS read error" and "press F6 to install Intel RAID driver" when installing Windows on my motherboard?

Answer: To solve this issue, disable the IPMI jumper. Another solution is to use a USB floppy drive instead of the onboard floppy drive. For the IPMI jumper location, please check Chapter 1.

Question: What is the heatsink part number for my X10SLM+/X10SLL+ Motherboard Series?

Answer: For the 1U passive heatsink, ask for SNK-P0046P (back plate is included). For the 2U active heatsink, use SNK-P0046A4.

Question: Why can't I recover the BIOS even when I've followed the instructions in the user's manual for the motherboard?

Answer: Please disable the IPMI jumper and try it again. For the jumper location, please check Chapter 1.

3-4 Battery Removal and Installation

Battery Removal

To remove the onboard battery, follow the steps below:

1. Power off your system and unplug your power cable.
2. Locate the onboard battery as shown on the next page.
3. Using a tool such as a pen or a small screwdriver, push the battery lock outwards to unlock it. Once unlocked, the battery will pop out from the holder.
4. Remove the battery.

Proper Battery Disposal

Warning: Please handle used batteries carefully. Do not damage the battery in any way; a damaged battery may release hazardous materials into the environment. Do not discard a used battery in the garbage or a public landfill. Please comply with the regulations set up by your local hazardous waste management agency to dispose of your used battery properly.

Battery Installation

1. To install an onboard battery, follow the steps 1 & 2 above and continue below:
2. Identify the battery's polarity. The positive (+) side should be facing up.
3. Insert the battery into the battery holder and push it down until you hear a click to ensure that the battery is securely locked.

Warning: When replacing a battery, be sure to only replace it with the same type.

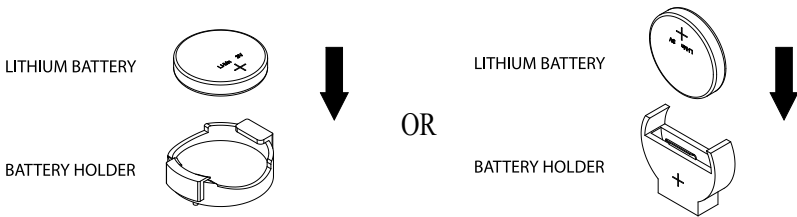

3-5 Returning Merchandise for Service

A receipt or copy of your invoice marked with the date of purchase is required before any warranty service will be rendered. You can obtain service by calling your vendor for a Returned Merchandise Authorization (RMA) number. For faster service, you may also obtain RMA authorizations online (<http://www.supermicro.com/RmaForm/>). When you return the motherboard to the manufacturer, the RMA number should be prominently displayed on the outside of the shipping carton, and mailed prepaid or hand-carried. Shipping and handling charges will be applied for all orders that must be mailed when service is complete.

This warranty only covers normal consumer use and does not cover damages incurred in shipping or from failure due to the alteration, misuse, abuse or improper maintenance of products.

During the warranty period, contact your distributor first for any product problems.

Chapter 4

BIOS

4-1 Introduction

This chapter describes the AMI BIOS Setup Utility for the X10SLM+/X10SLL+/X10SLM-LN4F. The ROM BIOS is stored in a Flash EEPROM and can be easily updated. This chapter describes the basic navigation of the AMI BIOS Setup Utility setup screens.



Note: For AMI BIOS Recovery, please refer to the UEFI BIOS Recovery Instructions in Appendix C.

Starting BIOS Setup Utility

To enter the AMI BIOS Setup Utility screens, press the <Delete> key while the system is booting up.



Note: In most cases, the <Delete> key is used to invoke the AMI BIOS setup screen. There are a few cases when other keys are used, such as <F1>, <F2>, etc.

Each main BIOS menu option is described in this manual. The Main BIOS setup menu screen has two main frames. The left frame displays all the options that can be configured. Grayed-out options cannot be configured. Options in blue can be configured by the user. The right frame displays the key legend. Above the key legend is an area reserved for a text message. When an option is selected in the left frame, it is highlighted in white. Often a text message will accompany it. (**Note:** the AMI BIOS has default text messages built in. Supermicro retains the option to include, omit, or change any of these text messages.)

The AMI BIOS Setup Utility uses a key-based navigation system called "hot keys". Most of the AMI BIOS setup utility "hot keys" can be used at any time during the setup navigation process. These keys include <F1>, <F10>, <Enter>, <ESC>, arrow keys, etc.



Note: Options printed in **Bold** are default settings.

How To Change the Configuration Data

The configuration data that determines the system parameters may be changed by entering the AMI BIOS Setup utility. This Setup utility can be accessed by pressing at the appropriate time during system boot.

How to Start the Setup Utility

Normally, the only visible Power-On Self-Test (POST) routine is the memory test. As the memory is being tested, press the <Delete> key to enter the main menu of the AMI BIOS Setup Utility. From the main menu, you can access the other setup screens. An AMI BIOS identification string is displayed at the left bottom corner of the screen, below the copyright message.

Warning: Do not upgrade the BIOS unless your system has a BIOS-related issue. Flashing the wrong BIOS can cause irreparable damage to the system. In no event shall Supermicro be liable for direct, indirect, special, incidental, or consequential damages arising from a BIOS update. If you have to update the BIOS, do not shut down or reset the system while the BIOS is updating. This is to avoid possible boot failure.

4-2 Main Setup

When you first enter the AMI BIOS Setup Utility, you will enter the Main setup screen. You can always return to the Main setup screen by selecting the Main tab on the top of the screen. The Main BIOS Setup screen is shown below.

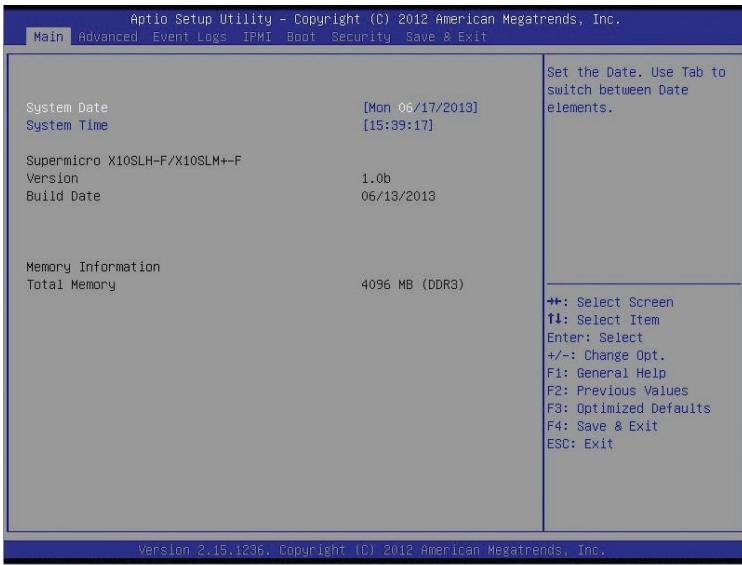

The following Main menu items will be displayed:

System Date/System Time

Use this option to change the system time and date. Highlight *System Date* or *System Time* using the arrow keys. Enter new values through the keyboard. Press the <Tab> key or the arrow keys to move between fields. The date must be entered in Day MM/DD/YY format. The time is entered in HH:MM:SS format.



Note: The time is in the 24-hour format. For example, 5:30 P.M. appears as 17:30:00.

The following BIOS items will also be displayed:

Supermicro X10SLH-F/ X10SLM+-F

Version

Build Date

Memory Information

Total Memory

4-3 Advanced Setup Configurations

Use the arrow keys to select Boot Setup and press <Enter> to access the submenu items:

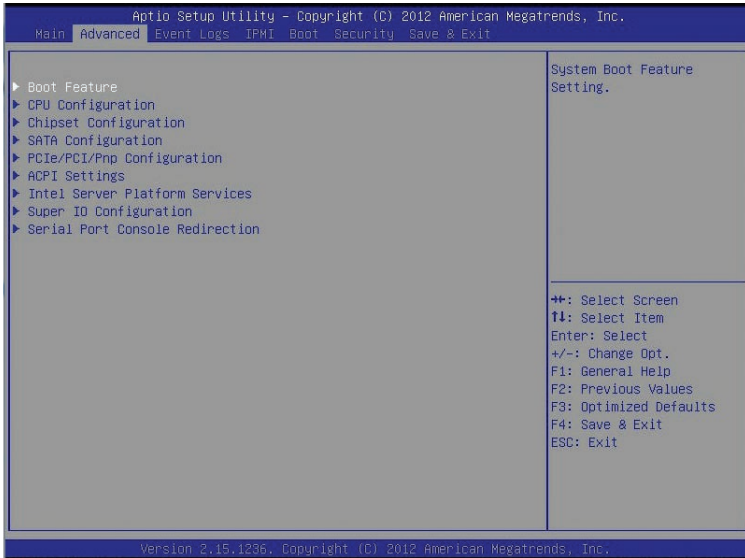

Warning: Take Caution when changing the Advanced settings. An incorrect value, a very high DRAM frequency, or an incorrect DRAM timing setting may cause system to become unstable. When this occurs, revert to the setting to the manufacture default setting.

► Boot Feature

Quiet Boot

This feature selects the screen display between POST messages or the OEM logo at bootup. Select Disabled to display the POST messages. Select Enabled to display the OEM logo instead of the normal POST messages. The options are **Enabled** and Disabled.

AddOn ROM Display Mode

This feature sets the display mode for the Option ROM. Select Keep Current to display the current AddOn ROM setting. Select Force BIOS to display the Option ROM mode set by the system BIOS. The options are **Force BIOS** and Keep Current.

Bootup Num-Lock

This feature selects the Power-on state for the Numlock key. The options are Off and **On**.

Wait For 'F1' If Error

Select Enabled to force the system to wait until the 'F1' key is pressed if an error occurs. The options are Disabled and **Enabled**.

Interrupt 19 Capture

Interrupt 19 is the software interrupt that handles the boot disk function. When this item is set to Enabled, the ROM BIOS of the host adaptors will "capture" Interrupt 19 at bootup and allow the drives that are attached to these host adaptors to function as bootable disks. If this item is set to Disabled, the ROM BIOS of the host adaptors will not capture Interrupt 19, and the drives attached to these adaptors will not function as bootable devices. The options are **Enabled** and Disabled.

Re-try Boot

If this item is enabled, the BIOS will automatically reboot the system from a specified boot device after its initial boot failure. The options are **Disabled**, Legacy Boot, and EFI Boot.

►Power Configuration**Watch Dog Function**

If enabled, the Watch Dog Timer will allow the system to reboot when it is inactive for more than 5 minutes. The options are Enabled and **Disabled**.

Power Button Function

This feature controls how the system shuts down when the power button is pressed. Select 4_Seconds_Override for the user to power off the system after pressing and holding the power button for 4 seconds or longer. Select Instant Off to instantly power off the system as soon as the user presses the power button. The options are 4 Second Override and **Instant Off**.

Restore on AC Power Loss

Use this feature to set the power state after a power outage. Select Power-Off for the system power to remain off after a power loss. Select Power-On for the system power to be turned on after a power loss. Select Last State to allow the system to resume its last power state before a power loss. The options are Power-On, Stay-Off and **Last State**.

►CPU Configuration

The following CPU information will be displayed:

- Type of CPU
- CPU Signature
- CPU Stepping
- Microcode Patch
- Maximum CPU Speed
- Minimum CPU Speed
- CPU Speed
- Processor Cores
- Intel HT(Hyper-Threading) Technology
- Intel VT-x (Virtualization) Technology
- Intel SMX (Safer Mode Extensions) Technology
- 64-bit
- EIST (Enhanced Intel SpeedStepTechnology) Technology
- CPU C3 State
- CPU C6 State
- CPU C7 State
- L1 Data Cache
- L1 Code Cache
- L2 Cache
- L3 Cache

Hyper-threading

Select Enabled to support Intel Hyper-threading Technology to enhance CPU performance. The options are **Enabled** and Disabled.

Active Processor Cores

This feature determines how many CPU cores will be activated for each CPU. When All is selected, all cores in the CPU will be activated. (Please refer to Intel's web site for more information.) The options are **All** and 1.

Limit CPUID Maximum

Select Enabled to set the maximum CPU ID value and to boot the legacy operating systems that cannot support processors with extended CPUID functions. The options are Enabled and **Disabled** (for the Windows OS).

Execute-Disable Bit (Available if supported by the OS & the CPU)

Set to Enabled to enable the Execute Disable Bit which will allow the processor to designate areas in the system memory where an application code can execute and where it cannot, thus preventing a worm or a virus from flooding illegal codes to overwhelm the processor or damage the system during an attack. The default is **Enabled**. (Refer to Intel and Microsoft Web Sites for more information.)

Intel® Virtualization Technology (Available when supported by the CPU)

Select Enabled to use the Intel Virtualization Technology to allow one platform to run multiple operating systems and applications in independent partitions, creating multiple "virtual" systems in one physical computer. The options are **Enabled** and Disabled.

Hardware Prefetcher (Available when supported by the CPU)

If set to Enabled, the hardware prefetcher will prefetch streams of data and instructions from the main memory to the L2 cache to improve CPU performance. The options are Disabled and **Enabled**.

Adjacent Cache Line Prefetch (Available when supported by the CPU)

Select Enabled for the CPU to prefetch both cache lines for 128 bytes as comprised. Select Disabled for the CPU to prefetch both cache lines for 64 bytes. The options are Disabled and **Enabled**.



Note: If there is any change to this setting, you will need to power off and restart the system for the change to take effect. Please refer to Intel's web site for detailed information.

CPU AES

Select Enable to enable Intel CPU Advanced Encryption Standard (AES) Instructions for CPU to enhance data integrity. The options are **Enabled** and Disabled.

EIST

EIST (Enhanced Intel SpeedStep Technology) allows the system to automatically adjust processor voltage and core frequency in an effort to reduce power consumption and heat dissipation. **Please refer to Intel's web site for detailed information.** The options are Disabled and **Enabled**.

Turbo Mode

Select Enabled to allow processor cores to run faster than the frequency recommended by the manufacturer. The options are Disabled and **Enabled**. If this feature is set to Enabled, the following items will display:

CPU Power Limit1 (Available when "Turbo Mode" is set to Enabled)

Use this feature to set the power limit for CPU1. Press "+" or "-" on your keyboard to change this value. Enter 0 to use the manufacture default setting.

CPU Power Limit1 Time (Available when "Turbo Mode" is set to Enabled)

This item allows the user to determine how long CPU1 should operate at the power limit set by the user for the item above. Press "+" or "-" on your keyboard to change this value. Enter 0 to use the manufacture default setting.

CPU Power Limit2 (Available when "Turbo Mode" is set to Enabled)

Use this feature to set the power limit for CPU2. Press "+" or "-" on your keyboard to change this value. Enter 0 to use the manufacture default setting.

DDR Power Limit1 (Available when "Turbo Mode" is set to Enabled)

Use this feature to set the power limit for DDR1. Press "+" or "-" on your keyboard to change this value. Enter 0 to use the manufacture default setting.

DDR Power Limit1 Time (Available when "Turbo Mode" is set to Enabled)

This item allows the user to determine how long DDR1 should operate at the power limit set by the item above. Press "+" or "-" on your keyboard to change this value. Enter 0 to use the manufacture default setting.

DDR Power Limit2 (Available when "Turbo Mode" is set to Enabled)

Use this feature to set the power limit for DDR2. Press "+" or "-" on your keyboard to change this value. Enter 0 to use the manufacture default setting.

1-Core Ratio Limit (Available when "Turbo Mode" is set to Enabled)

This feature increases (multiplies) 1 clock speed in the CPU core in relation to the bus speed when one CPU core is active. Press "+" or "-" on your keyboard to change this value. Enter 0 to use the manufacture default setting.

2-Core Ratio Limit (Available when "Turbo Mode" is set to Enabled)

This feature increases (multiplies) 2 clock speeds in the CPU core in relation to the bus speed when two CPU cores are active. Press "+" or "-" on your keyboard to change this value. Enter 0 to use the manufacture default setting.

Energy Performance

Use this feature to select an appropriate fan setting to achieve the maximum system performance (with maximum cooling) or to achieve maximum energy efficiency (with maximum power saving). The fan speeds are controlled by the firmware management via IPMI 2.0. The options are Performance, **Balanced Performance**, Balanced Energy, and Energy Efficient.

VR Current Value

Use this feature to set the limit on the current voltage regulator. Press "+" or "-" on your keyboard to change this value. Enter 0 to use the manufacture default setting.

CPU C-States

C-States architecture, a processor power management platform developed by Intel, can further reduce power consumption from the basic C1 (Halt State) state that blocks clock cycles to the CPU. Select Enabled for CPU C-Sates support. The options are **Enabled** and Disabled. If this feature is set to Enabled, the following items will display:

Enhanced C1 State (Available when "CPU C-States" is set to Enabled)

Select Enabled to enable Enhanced C1 Power State to boost system performance. The options are **Enabled** and Disabled.

CPU C3 Report (Available when "CPU C-States" is set to Enabled)

Select Enabled to allow the BIOS to report the CPU C3 State (ACPI C2) to the operating system. During the CPU C3 State, the CPU clock generator is turned off. The options are **Enabled** and Disabled.

CPU C6 Report (Available when "CPU C-States" is set to Enabled)

Select Enabled to allow the BIOS to report the CPU C6 State (ACPI C3) to the operating system. During the CPU C6 State, the power to all caches is turned off. The options are **Enabled** and Disabled.

C6 Latency (Available when "CPU C-States" is set to Enabled)

Select Short to set a short delay time(period) during which the BIOS reports CPU C6 State (ACPI C3) to the operating system. Select Long to set a long delay time(period) during which the BIOS reports CPU C6 State (ACPI C3) to the operating system. The options are **Short** and Long.

CPU C7 Report (Available when "CPU C-States" is set to Enabled)

Select Enabled to allow the BIOS to report the CPU C7 State (ACPI C3) to the operating system. CPU C7 State is a processor-specific low C-State. The options are **Enabled** and Disabled.

C7 Latency (Available when "CPU C-States" is set to Enabled)

Select Short to set a short delay time(period) during which the BIOS reports CPU C7 State (ACPI C3) to the operating system. Select Long to set a long delay time(period) during which the BIOS reports CPU C7 State (ACPI C3) to the operating system. The options are Short and **Long**.

C1 State Auto Demotion

When this item is enabled, the CPU will conditionally demote C3, C6 or C7 requests to C1 based on un-cored auto-demote information. The options are Disabled and **Enabled**.

C3 State Auto Demotion

When this item is enabled, the CPU will conditionally demote C6 or C7 requests to C3 based on un-cored auto-demote information. The options are Disabled and **Enabled**.

C-State Pre-Wake

Select Enabled to support C State Pre-Wake State features. The options are **Enabled** and Disabled

Package C-State limit

Select Auto for the AMI BIOS to automatically set the limit on the C-State package register. The options are C0, C1, C6, C7 and **Auto**.

LakeTiny Feature

Select Enabled for LakeTiny feature support. The options are **Disabled** and Enabled.

ACPI T State

Select Enabled for ACPI T state (processor throttling) feature support. The options are Disabled and **Enabled**.

Chipset Configuration

Warning: Setting the wrong values in the following sections may cause the system to malfunction.

►System Agent (SA) Configuration

This item displays the information for the system Agent.

- System Agent Bridge Name
- VT-d Capability

VT-d

Select Enabled to enable Intel's Virtualization Technology support for Direct I/O VT-d by reporting the I/O device assignments to VMM through the DMAR ACPI Tables. This feature offers fully-protected I/O resource-sharing across the Intel platforms, providing the user with greater reliability, security and availability in networking and data-sharing. The settings are **Enabled** and Disabled.

►PCI-E Configuration

This item displays the information of the (graphics) device installed on a PCI-E slot.

- Riser Card on CPU Slot 6
- CPU Slot 6 PCI-E 3.0 x8/x16
- CPU Slot 6 PCI-E 3.0 x8/x16 Gen X
- CPU Slot 5 PCI-E 3.0 x8
- CPU Slot 5 PCI-E 3.0 x8 Gen X

Detect Non-Compliance Device

Select Enabled for the AMI BIOS will automatically detect a PCI-E device that is not in compliance. The options are Enabled and **Disabled**.

Program PCI-E ASPM After OpROM

PCI-E ASPM, Active State Power Management for PCI-Express slots, is a power management protocol used to manage power consumption of serial-link devices installed on PCI-Exp slots during prolonged off-peak time. If this item is set to Enabled, PCI-E ASPM will be programmed after OpROM. If this item is set to

Disabled, the PCI-E ASPM will be programmed before OpROM. The options are Enabled and **Disabled**.

CPU SLOT6 PCI-E 3.0 x8/x16 ASPM/CPU SLOT5 PCI-E 3.0 x8 ASPM

This feature configures the ASPM (Active State Power Management) settings for the PCI-E device installed on CPU SLOT6 or CPU SLOT5. The options are Disabled, **Auto**, ASPM L0s, ASPM L1, and ASPM L0sL1.

DMI Link ASPM Control

This feature configures the ASPM (Active State Power Management) settings for the DMI link. The options are Disabled, L0s, L1, and **L0sL1**.

PCH DMI Link ASPM Control

This feature configures the ASPM (Active State Power Management) settings for the DMI link on the PCH chip. The options are Disabled and **Enabled**.

PCH SLOT4 PCI-E 2.0 x2/4 (x8) ASPM

This feature configures the ASPM (Active State Power Management) settings for the PCI-E device installed on PCH SLOT4. The options are Disabled, L0s, L1, L0sL1, and **Auto**.

►Memory Configuration

This item displays the information on the memory modules installed on the motherboard.

- Memory RC Version
- Memory Frequency
- Total Memory
- Memory Voltage
- DIMM A1
- DIMM A2
- DIMM B1
- DIMM B2
- CAS Latency (tCL)
- Minimum Delay Time

- CAS to RAS (tRCDmin)
- Row Precharge (tRPmin)
- Active to Precharge (tRASmin)

Memory Frequency Limiter

This feature sets the limit of memory frequency for DIMM modules installed on the the motherboard. The options are 1067 (MHz), 1333 (MHz), 1600 (MHz), and **Auto**.

Max TOLUD (Top of Low Usable DRAM)

This feature sets the maximum TOLUD value, which specifies the "Top of Low Usable DRAM" memory space to be used by internal graphics devices, GTT Stolen Memory, and TSEG, respectively, if these devices are enabled. The options are Enabled and **Dynamic**, 1 GB, 1.25 GB, 1.5 GB, 1.75 GB, 2 GB, 2.25 GB, 2.5 GB, 2.75 GB, 3 GB and 3.25 GB.



Note: TSEG is a block of memory that is only accessible by the processor while operating in SMM mode.

Memory Scrambler

This feature enables or disables memory scrambler support for memory error correction. The settings are **Enabled** and Disabled.

►PCH-IO Configuration

This item displays the information for PCH-IO Chip.

- Intel PCH Rev ID
- USB Configuration
- USB Devices

EHCI1

Select Enabled to enable EHCI (Enhanced Host Controller Interface) Controller 1 for USB 2.0 support. One EHCI controller must always be enabled. The settings are **Enabled** and Disabled.

EHCI2

Select Enabled to enable EHCI (Enhanced Host Controller Interface) Controller 2 for USB 2.0 support. One EHCI controller must always be enabled. The settings are **Enabled** and Disabled.

Legacy USB Support

This feature enables support for legacy USB devices. Select Auto to disable legacy support if USB devices are not present. Select Disable to have USB devices available only for EFI applications. The options are **Enabled**, Disabled and Auto.

Port 60/64 Emulation

This feature enables or disables I/O port 60h/64h emulation support. Select Enabled for complete USB keyboard legacy support for Operating Systems that cannot detect the presence of a legacy USB device. The options are Disabled and **Enabled**.

XHCI Hand-Off

This item is a work-around for Operating Systems that do not have XHCI (Extensible Host Controller Interface) hand-off support. The XHCI ownership change should be claimed by the XHCI driver. The settings are **Enabled** and Disabled.

EHCI Hand-Off

This item is for Operating Systems that do not support Enhanced Host Controller Interface (EHCI) hand-off. When this item is set to Enabled, EHCI ownership change will be claimed by the EHCI driver. The settings are Enabled and **Disabled**.

XHCI Mode

Use this feature to select the operation mode for the XHCI (Extensible Host Controller Interface) controller. The settings are **Smart Auto**, Auto, Enabled, Disabled and Manual.

►SATA Configuration

When this submenu is selected, the AMI BIOS automatically detects the presence of the SATA Devices and displays the following items:

SATA Controllers

This item Enables or Disables the built-in SATA controllers on the motherboard. The options are **Enabled** and Disabled.

SATA Mode Selection

This item selects the SATA mode for a device installed on a SATA drive. The options are IDE, **AHCI**, and RAID.

SATA RAID Option ROM/UEFI Driver

This item enables either the on board SATA option ROM or the EFI driver. The options are **Enabled** or Disabled.

If AHCI is selected in SATA Mode Selection above, the following items are displayed:

Serial ATA Port 0~ Port 5

This item displays the information detected on the SATA device installed on a particular SATA port.

- Model number of drive and capacity
- Software Preserve Support

Port 0 ~ Port 5 Hot Plug

This feature designates the port specified as hot pluggable. Set this item to Enabled to enable hot-plugging support. The options are Hard Disk Drive and Solid State Drive.

Port 0 ~ Port 5 SATA Device Type

This feature configures the selected SATA port to support either a solid state drive or hard disk drive. The options are **Hard Disk Drive** and Solid Sate Drive.

Port 0 ~ Port 5 Spin Up Device

On an edge detect from 0 to 1, set this item to allow the PCH to start a COMRE-SET initialization sequence to the device. The options are Enabled and **Disabled**.

SATA Gen3 Port 0 ~ Port 5 Length Value

Use this item to set a value for Gen3 length test. The values that can be selected ranges from **[00 0000b]** through [00 1111b].

SATA Gen2 Port 0 ~ Port 5 Length Value

Use this item to set a value for Gen3 length test. The values that can be selected ranges from **[00 0000b]** through [00 1111b].

If IDE is selected in SATA Mode Selection above, the following items are displayed:

Serial ATA Port 0 ~ Port 5

This item displays the information detected on the installed SATA drives on the particular SATA port.

- Model number of drive and capacity
- Software Preserve Support

SATA Gen3 Port 0 ~ Port 5 Length Value

Set this item to select a value for Gen3 length test. The values that can be selected ranges from [00 0000b] through [00 1111b].

SATA Gen2 Port 0 ~ Port 5 Length Value

Set this item to select a value for Gen2 length test. The values that can be selected ranges from [00 0000b] through [00 1111b].

If RAID is selected in SATA Mode Selection above, the following items are displayed:

Serial ATA Port 0 ~ Port 5

This item displays the information detected on the installed SATA drives on the particular SATA port.

- Model number of drive and capacity
- Software Preserve Support

Port 0 ~ Port 5 Hot Plug

This feature designates this port as hot pluggable. Set this item to Enabled to enable hot-plugging. The options are **Hard Disk Drive** and Solid State Drive.

Port 0 ~ Port 5 SATA Device Type

This feature configures the selected SATA port to support either a solid state drive or hard disk drive. Set this item to Enabled to enable hot-plugging. The options are Enabled and Disabled.

Port 0 ~ Port 5 Spin Up Device

On an edge detect from 0 to 1, set this item to allow the PCH to start a COMRESET initialization sequence to the device. The options are Enabled and **Disabled**.

►PCIe/PCI/PnP Configuration

This feature allows the user to set the PCI/PnP configurations for the following items:

Above 4G Decoding

Select Enabled for 64-bit devices to be decoded above the 4GB address space if 64bit PCI decoding is supported by the system. The options are **Disabled** and Enabled.

VGA Palette Snoop

Select Enabled to support VGA palette register snooping which will allow a PCI card that does not contain its own VGA color palette to mimic the color palette of the video card installed on the motherboard for proper color display. The options are **Disabled** and Enabled.

PERR# Generation

Select Enabled to allow a PCI device to generate a PERR number for a PCI Bus Signal Error Event. The options are **Enabled** and Disabled.

SERR# Generation

Select Enabled to allow a PCI device to generate an SERR number for a PCI Bus Signal Error Event. The options are **Enabled** and Disabled.

CPU SLOT6 PCI-E 3.0 X8/X16 OPROM

Use this feature to enable or disable PCIe slot Option ROMs to boot the computer using a device installed on the slot specified. The options are Disabled, **Legacy** and EFI.

CPU SLOT5 PCI-E 3.0 X8 OPROM

Use this feature to enable or disable PCIe slot Option ROMs to boot the computer using a device installed on the slot specified. The options are Disabled, **Legacy** and EFI.

PCH SLOT4 PCI-E 2.0 X2/4 (IN X8) OPROM

Use this feature to enable or disable PCIe slot Option ROMs to boot the computer using a device installed on the slot specified. The options are Disabled, **Legacy** and EFI.

Launch Storage OPROM Policy

This feature controls how the system executes UEFI (Unified Extensible Firmware Interface) and legacy storage OPROM. Select Legacy Only to boot the system using a legacy device installed in a PCI slot. The options are UEFI Only and **Legacy Only**.

Other PCI Device ROM Priority

This feature selects a PCI device OPROM to launch for system boot if this device is not a network, mass storage, or video device. The options are UEFI Only and **Legacy Only**.

Onboard LAN1 Option ROM/Onboard LAN2 Option ROM

Select iSCSI for iSCSI Option ROM support which will allow the user to boot the computer using an iSCSI device installed in a LAN port specified. Select PXE (Preboot Execution Environment) to boot the computer using a PXE device installed

in a LAN port specified. Select Disabled to prevent system boot by using a device installed in a LAN port. The options are Disabled, **PXE** and iSCSI.

VGA Priority

This feature selects the priority between the onboard and first offboard video device that has been detected. The options are **Onboard** and Offboard.

Network Stack

Select Enabled to enable PXE (Preboot Execution Environment) or UEFI (Unified Extensible Firmware Interface) for network stack support. The options are Enabled and **Disabled**.

►ACPI Settings

High Precision Event Timer

Select Enabled to activate the High Performance Event Timer (HPET) that produces periodic interrupts at a much higher frequency than a Real-time Clock (RTC) does in synchronizing multimedia streams, providing smooth playback and reducing the dependency on other timestamp calculation devices, such as an x86 RDTSC Instruction embedded in the CPU. The High Performance Event Timer is used to replace the 8254 Programmable Interval Timer. The options are **Enabled** and Disabled.

ACPI Sleep State

This feature selects the ACPI Sleep State for the system when it is in suspend mode. The options are Suspend Disabled and **S3 only (suspend to RAM)**.

WHEA Support

Select Enabled to enable Windows Hardware Error Architecture (WHEA) support for the Windows 2008 (or a later version) operating system. The options are **Enabled** and Disabled.

►Intel Server Platform Services Configuration

The following status information for this motherboard are displayed:

- ME BIOS Interface Version
- SPS Version
- ME FW (Firmware) Status Value
- ME FW State
- ME FW Operation State

- ME FW Error Code
- ME NM FW Status Value
- BIOS Booting Mode
- Cores Disabled
- ME FW SKU Information
- End-of-POST Status

► Super IO Configuration

Super IO Chip NCT6776D

► Serial Port 1 Configuration/Serial Port 2 Configuration

Serial Port 1/ Serial Port 2

Select Enabled to enable the onboard serial port specified by the user. The options are **Enabled** and Disabled.

Change Settings

This option specifies the base I/O port address and the Interrupt Request address of Serial Port 1 and 2. Select Auto to let the BIOS automatically assign the base I/O and IRQ address.

The options for Serial Port 1 are **Auto**, (IO=3F8h; IRQ=4), (IO=3F8h; IRQ=3, 4, 5, 6, 7, 9, 10, 11), (IO=2F8h; IRQ=3, 4, 5, 6, 7, 9, 10, 11), (IO=3E8h; IRQ=3, 4, 5, 6, 7, 9, 10, 11), and (IO=2E8h; IRQ=3, 4, 5, 6, 7, 9, 10, 11).

The options for Serial Port 2 are **Auto**, (IO=2F8h; IRQ=3), (IO=3F8h; IRQ=3, 4, 5, 6, 7, 9, 10, 11), (IO=2F8h; IRQ=3, 4, 5, 6, 7, 9, 10, 11), (IO=3E8h; IRQ=3, 4, 5, 6, 7, 9, 10, 11), and (IO=2E8h; IRQ=3, 4, 5, 6, 7, 9, 10, 11).

► Serial Port Console Redirection

Console Redirection (COM1, COM2, SOL)

Use this feature to enable console redirection for COM1, COM2 and SOL ports. The options are Enabled and Disabled. The default for both COM ports is **Disabled**. The default for SOL is **Enabled**.

► Console Redirection Settings

Configure the following options for the Console Redirection Settings. The most common settings are set as default:

Terminal Type

This feature allows the user to select the target terminal emulation type for Console Redirection. Select VT100 to use the ASCII character set. Select VT100+ to add color and function key support. Select ANSI to use the extended ASCII character set. Select VT-UTF8 to use UTF8 encoding to map Unicode characters into one or more bytes. The options are VT100, **VT100+**, VT-UTF8, and ANSI.

Bits Per Second

This item sets the transmission speed for a serial port used in Console Redirection. Make sure that the same speed is used in the host computer and the client computer. A lower transmission speed may be required for long and busy lines. The options are 9600, 19200, 38400, 57600, and **115200** (bits per second).

Data Bits

Use this feature to set the data transmission size for Console Redirection. The options are 7 and **8** (Bits).

Parity

A parity bit can be sent along with regular data bits to detect data transmission errors. Select Even if the parity bit is set to 0, and the number of 1's in data bits is even. Select Odd if the parity bit is set to 0, and the number of 1's in data bits is odd. Select None if you do not want to send a parity bit with your data bits in transmission. Select Mark to add mark as a parity bit to be sent along with the data bits. Select Space to add a Space as a parity bit to be sent with your data bits. The options are **None**, Even, Odd, Mark, and Space.

Stop Bits

A stop bit indicates the end of a serial data packet. Select 1 Stop Bit for standard serial data communication. Select 2 Stop Bits if slower devices are used. The options are **1** and 2.

Flow Control

This feature allows the user to set the flow control for Console Redirection to prevent data loss caused by buffer overflow. Send a "Stop" signal to stop sending data when the receiving buffer is full. Send a "Start" signal to start sending data when the receiving buffer is empty. The options are **None** and Hardware RTS/CTS.

VT-UTF8 Combo Key Support

Select Enabled to enable VT-UTF8 Combination Key support for ANSI/VT100 terminals. The options are **Enabled** and Disabled.

Recorder Mode

Select Enabled to capture the data displayed on a terminal and send it as text messages to a remote server. The options are **Disabled** and Enabled.

Resolution 100x31

Select Enabled for extended-terminal resolution support. The options are Disabled and **Enabled**.

Legacy OS Redirection

Use this feature to select the number of rows and columns used in Console Redirection for legacy OS support. The options are **80x24** and 80x25.

Putty Keypad

Use this feature to select function key and keypad setting on Putty. The options are **VT100**, LINUX, XTERMR6, SCO, ESCN, and VT400.

Redirection After BIOS POST

If **Always Enabled** is selected, Legacy Console Redirection will be enabled for Legacy OS after BIOS POST (Power-On Self Test) is completed. The options are **Always Enabled**, and BootLoader.

Serial Port for Out-of-Band Management/Windows Emergency Management Services (EMS)

This item allows the user to configure Console Redirection settings to support Out-of-Band Serial Port management.

Console Redirection

Select Enabled to use a COM Port selected by the user for Console Redirection. The options are Enabled and **Disabled**. If this item is set to Enabled, the following items will display.

►Console Redirection Settings

This feature allows the user to specify how the host computer will exchange data with the client computer, which is the remote computer used by the user.

Out-of-Band-Mgmt (Management) Port

Use this feature to select the port to be used for out-of-band management. The options are **COM1** and COM2

Terminal Type

This feature allows the user to select the target terminal emulation type for Console Redirection. Select VT100 to use the ASCII character set. Select VT100+ to add color and function key support. Select ANSI to use the extended ASCII character set. Select VT-UTF8 to use UTF8 encoding to map Unicode characters into one or more bytes. The options are ANSI, VT100, VT100+, and **VT-UTF8**.

Bits Per Second

This item sets the transmission speed for a serial port used in Console Redirection. Make sure that the same speed is used in the host computer and the client computer. A lower transmission speed may be required for long and busy lines. The options are 9600, 19200, 57600, and **115200** (bits per second).

Flow Control

This feature allows the user to set the flow control for Console Redirection to prevent data loss caused by buffer overflow. Send a "Stop" signal to stop sending data when the receiving buffer is full. Send a "Start" signal to start sending data when the receiving buffer is empty. The options are **None**, Hardware RTS/CTS, and Software Xon/Xoff.

Data Bits

Use this feature to set the data transmission size for Console Redirection. The options are 7 and **8** (Bits).

Parity

A parity bit can be sent along with regular data bits to detect data transmission errors. Select Even if the parity bit is set to 0, and the number of 1's in data bits is even. Select Odd if the parity bit is set to 0, and the number of 1's in data bits is odd. Select None if you do not want to send a parity bit with your data bits in transmission. Select Mark to add mark as a parity bit to be sent along with the data bits. Select Space to add a Space as a parity bit to be sent with your data bits. The options are **None**, Even, Odd, Mark, and Space.

Stop Bits

A stop bit indicates the end of a serial data packet. Select 1 Stop Bit for standard serial data communication. Select 2 Stop Bits if slower devices are used. The options are **1** and 2.

4-4 Event Logs

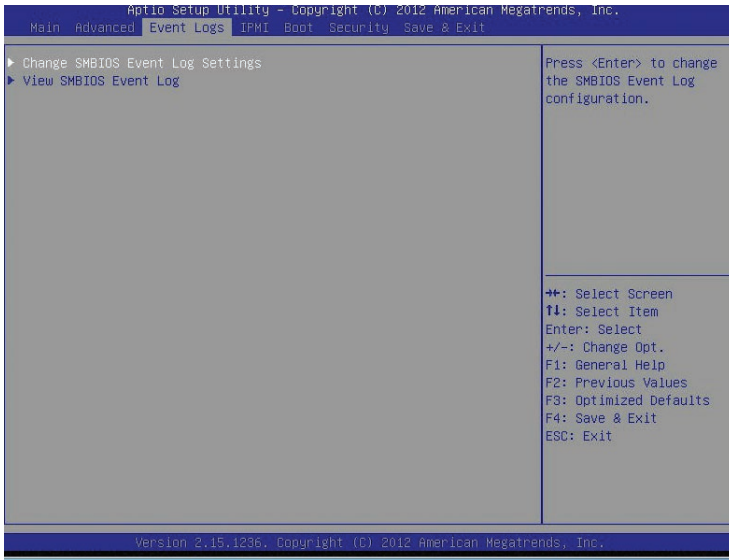

►Change SMBIOS Event Log Settings

Enabling/Disabling Options

SMBIOS Event Log

Change this item to enable or disable all features of the SMBIOS Event Logging during system boot. The options are **Enabled** and Disabled.

Erase Settings

Erase Event Log

If this feature is set to Yes, all logged events will be erased. The options are **No**, Yes, Next reset and Yes, Every reset.

When Log is Full

Select Erase Immediately for all messages to be automatically erased from the event log when the event log memory is full. The options are **Do Nothing** and Erase Immediately.

SMBIOS Event Log Standard Settings

Log System Boot Event

This option toggles the System Boot Event logging to enabled or disabled. The options are **Disabled** and Enabled.

MECI

The Multiple Event Count Increment (MECI) counter counts the number of occurrences. A duplicate event must happen before the MECI counter is incremented. This is a numeric value. The default value is **1**.

METW

Use the Multiple Event Time Window (METW) to define the length of time (in minute) it must pass before a duplicate log event entry is generated. Enter a number from 0 to 99. The default value is **60 (minutes)**.

►View SMBIOS Event Log

This section displays the contents of the SMBIOS Event Log.

4-5 IPMI

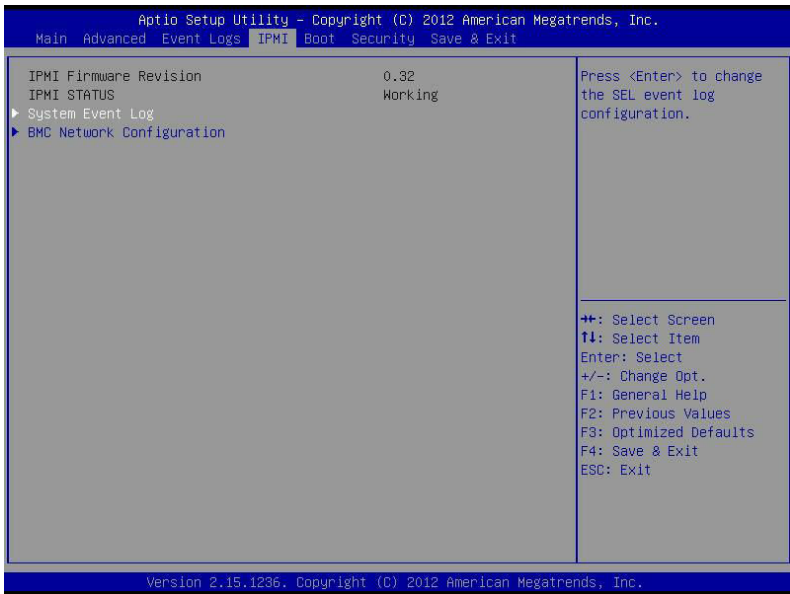

► System Event Log

IPMI Firmware Revision

This item indicates the IPMI firmware revision used in your system.

IPMI Status

This item indicates the status of the IPMI firmware installed in your system.

► System Event Log

Enabling/Disabling Options

SEL Components

Select Enabled for all system event logging at bootup. The options are **Enabled** and Disabled.

Erasing Settings

Erase SEL

Select Yes, On next reset to erase all system event logs upon next system reboot.
Select Yes, On every reset to erase all system event logs upon each system reboot.

Select No to keep all system event logs after each system reboot. The options are **No**, Yes, On next reset, and Yes, On every reset.

When SEL is Full

This feature allows the user to decide what the BIOS should do when the system event log is full. Select Erase Immediately to erase all events in the log when the system event log is full. The options are **Do Nothing** and Erase Immediately.

Custom EFI Logging Options

Log EFI Status Codes

Select Enabled to log EFI (Extensible Firmware Interface) Status Codes, Error Codes or Progress Codes. The options are **Enabled** and Disabled.



Note: After making changes on a setting, be sure to reboot the system for the changes to take effect.

►BMC Network Configuration

LAN Channel 1: This feature allows the user to configure the settings for LAN1 Port.

Update IPMI LAN Configuration

This feature allows the user to decide if the BIOS should configure the IPMI setting at next system boot. The options are No and **Yes**. If the option is set to Yes, the user is allow to configure the IPMI settings at next system boot:

IPMI LAN Selection

This feature allows the user to configure the IPMI LAN setting. The default setting is **Failover**.

IPMI Network Link Status

This feature displays the status of IPMI Network Link connections.

Configuration Address Source

This feature allows the user to select the source of the IP address for this computer. If Static is selected, you will need to know the IP address of this computer and enter it to the system manually in the field. If DHCP is selected, the BIOS will search for a DHCP (Dynamic Host Configuration Protocol) server in the network that is attached to and request the next available IP address for this computer. The options are **DHCP** and Static. The following items are assigned IP addresses automatically if DHCP is selected, or can be configured manually if Static is selected.

Station MAC Address

This item displays the Station MAC address for this computer. Mac addresses are 6 two-digit hexadecimal numbers.

Station IP Address

This item displays the Station IP address for this computer. This should be in decimal and in dotted quad form (i.e., 192.168.10.253).

Subnet Mask

This item displays the sub-network that this computer belongs to. The value of each three-digit number separated by dots should not exceed 255.

Gateway IP Address

This item displays the Gateway IP address for this computer. This should be in decimal and in dotted quad form (i.e., 192.168.10.253).

4-6 Boot Settings

Use this feature to configure Boot Settings:

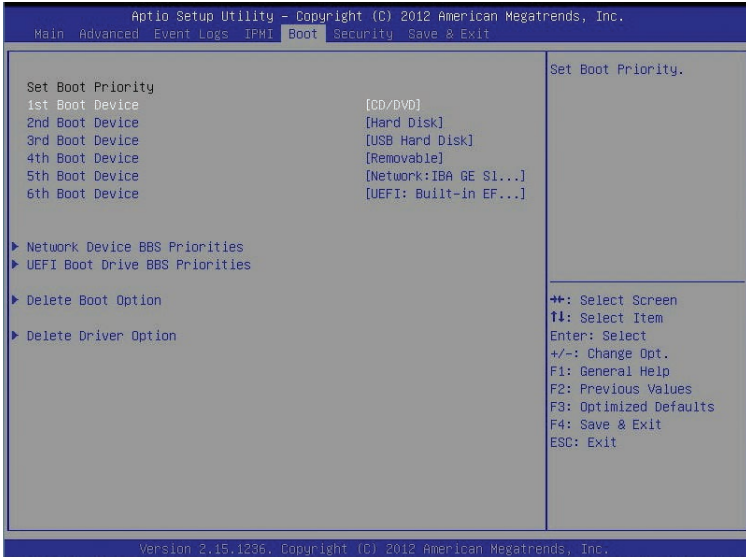

Set Boot Priority

This option prioritizes the order of bootable devices that the system to boot from. Press [ENTER] on each entry from top to bottom to select devices.

- 1st Boot Device
- 2nd Boot Device
- 3rd Boot Device
- 4th Boot Device
- 5th Boot Device
- 6th Boot Device

▶ Hard Disk BBS Priorities

▶ Network Device BBS Priorities

►UEFI Boot Drive BBS Priorities

This feature allows the user to specify which devices are boot devices and appear as boot devices to the system. The settings are [any detected boot device] and Disabled.

►Add New Boot Option

This feature allows the user to add a boot device from which the systems will boot after power-on.

Add Boot Option

Enter the name of the new boot option here.

Path for Boot Option

Enter the path of the new boot option here.

Create

Press Enter here to create the new boot option.

►Delete Boot Option

This feature allows the user to delete a previously defined boot device from which the systems boots during startup.

The settings are [any pre defined boot device]

►Add New Driver Option

This feature allows the user to add a boot device from which the systems boots during startup.

Add Driver Option

Enter the name of the new boot option here.

Path for Driver Option

Enter the path of the new boot option here.

Create

Press Enter here to create the new boot option.

►Delete Driver Option

This feature allows the user to delete a previously defined boot device from which the systems boots during startup.

The settings are [any pre defined boot device]

4-7 Security Settings

This menu allows the user to configure the following security settings for the system.

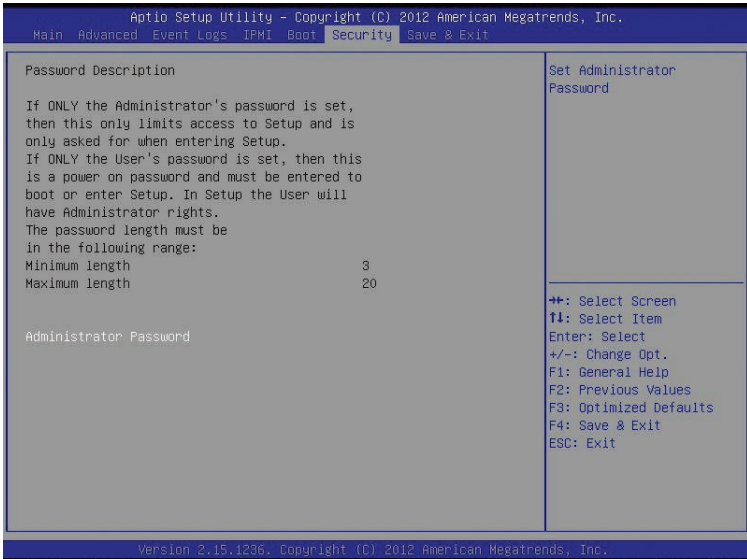

Administrator Password

Use this feature to set the Administrator Password which is required to enter the BIOS setup utility. The length of the password should be from 3 characters to 8 characters long.

4-8 Save & Exit

Select the Exit tab from the BIOS Setup Utility screen to enter the Exit BIOS Setup screen.

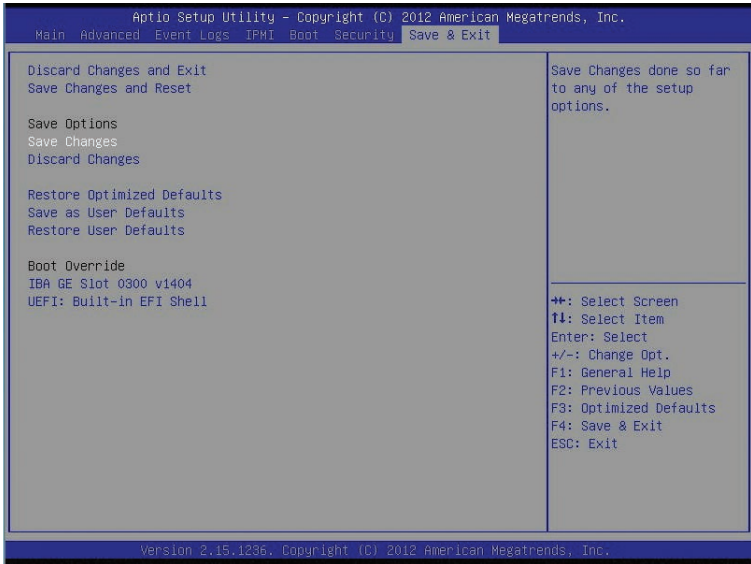

Discard Changes and Exit

Select this option to exit the BIOS Setup without making any permanent changes to the system configuration, and reboot the computer. Select Discard Changes and Exit from the Exit menu and press <Enter>.

Save Changes and Reset

When you have completed the system configuration changes, select this option to leave the BIOS Setup Utility and reboot the computer so that the new system configuration parameters can take effect. Select Save Changes and Exit from the Exit menu and press <Enter>.

Save Options

Save Changes

When you have completed the system configuration changes, select this option to save any changes that you have made. This will not reset (reboot) the system.

Discard Changes

Select this option and press <Enter> to discard all the changes and return to the AMI BIOS Utility Program.

Restore Optimized Defaults

To set this feature, select Restore Defaults from the Exit menu and press <Enter>. These are factory settings designed to maximize system performance.

Save As User Defaults

To set this feature, select Save as User Defaults from the Exit menu and press <Enter>. This enables the user to save any changes to the BIOS setup for future use.

Restore User Defaults

To set this feature, select Restore User Defaults from the Exit menu and press <Enter>. Use this feature to retrieve user-defined settings that were saved previously.

Boot Override

Listed on this section are other boot options for the system (i.e., Built-in EFI shell). Select an option and press <Enter>. Your system will boot to the selected boot option.

Appendix A

BIOS Error Beep Codes

During the POST (Power-On Self-Test) routines, which are performed each time the system is powered on, errors may occur.

Non-fatal errors are those which, in most cases, allow the system to continue with bootup. The error messages normally appear on the screen.

Fatal errors will not allow the system to continue to bootup. If a fatal error occurs, you should consult with your system manufacturer for possible repairs.

These fatal errors are usually communicated through a series of audible beeps. The numbers on the fatal error list correspond to the number of beeps for the corresponding error.

A-1 BIOS Error Beep Codes

BIOS Error Beep Codes		
Beep Code/LED	Error Message	Description
1 beep	Refresh	Circuits have been reset. (Ready to power up)
5 short beeps + 1 long beep	Memory error	No memory detected in the system
5 short beeps	Display error	System display error
OH LED On	System OH	System Overheat

Notes

Appendix B

Software Installation Instructions

B-1 Installing Software Programs

The Supermicro ftp site contains drivers and utilities for your system at <ftp://ftp.supermicro.com>. Some of these must be installed, such as the chipset driver.

After accessing the ftp site, go into the CDR_Images directory and locate the ISO file for your motherboard. Download this file to create a CD/DVD of the drivers and utilities it contains. (You may also use a utility to extract the ISO file if preferred.)

Another option is to go to the Supermicro Website at <http://www.supermicro.com/products/>. Find the product page for your motherboard here, where you may download individual drivers and utilities.

After creating a CD/DVD with the ISO files, insert the disk into the CD/DVD drive on your system and the display shown below should appear.

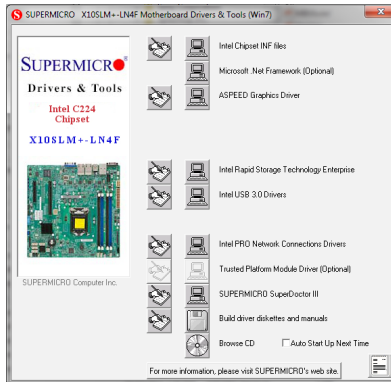

Driver/Tool Installation Display Screen

Note 1: Click the icons showing a hand writing on paper to view the readme files for each item. Click the computer icons to the right of these items to install each item (from top to the bottom) one at a time. **After installing each item, you must re-boot the system before moving on to the next item on the list.** The bottom icon with a CD on it allows you to view the entire contents.

Note 2: When making a storage driver diskette by booting into a Driver CD, please set the SATA Configuration to "Compatible Mode" and configure SATA as IDE in the BIOS Setup. After making the driver diskette, be sure to change the SATA settings back to your original settings.

B-2 Configuring SuperDoctor III

The SuperDoctor[®] III program is a web-based management tool that supports remote management capability. It includes Remote and Local Management tools. The local management is called SD III Client. The SuperDoctor III program allows you to monitor the environment and operations of your system. SuperDoctor III displays crucial system information such as CPU temperature, system voltages and fan status. See the figures below for examples of the SuperDoctor III interface.

 **Note 1:** The default User Name and Password for SuperDoctor III is ADMIN/ADMIN.

Note 2: When SuperDoctor III is first installed, it adopts the temperature threshold settings that have been set in BIOS. Any subsequent changes to these thresholds must be made within SuperDoctor III, as the SuperDoctor III settings override the BIOS settings. To set the BIOS temperature threshold settings again, you would first need to uninstall SuperDoctor III.



SuperDoctor[®] III Interface Display Screen (Health Information)



SuperDoctor® III Interface Display Screen (Remote Control)

 **Note:** The SuperDoctor III program and User's Manual can be downloaded from the Supermicro web site at <http://www.supermicro.com/products/accessories/software/SuperDoctorIII.cfm>. For Linux, we recommend that you use the SuperDoctor II application instead.

Notes

Appendix C

UEFI BIOS Recovery Instructions

Warning: Do not upgrade the BIOS unless your system has a BIOS-related issue. Flashing the wrong BIOS can cause irreparable damage to the system. In no event shall Supermicro be liable for direct, indirect, special, incidental, or consequential damages arising from a BIOS update. If you need to update the BIOS, do not shut down or reset the system while the BIOS is updating to avoid possible boot failure.

C-1 An Overview to the UEFI BIOS

The Unified Extensible Firmware Interface (UEFI) specification provides a software-based interface between the operating system and the platform firmware in the pre-boot environment. The UEFI specification supports an architecture-independent mechanism for add-on card initialization to allow the UEFI OS loader, which is stored in the add-on card, to boot up the system. UEFI offers a clean, hands-off control to a computer system at bootup.

C-2 How to Recover the UEFI BIOS Image (-the Main BIOS Block)

A UEFI BIOS flash chip consists of a recovery BIOS block, comprised of two boot blocks and a main BIOS block (a main BIOS image). The boot block contains critical BIOS codes, including memory detection and recovery codes for the user to flash a new BIOS image if the original main BIOS image is corrupted. When the system power is on, the boot block codes execute first. Once that is completed, the main BIOS code will continue with system initialization and bootup.



Note: Follow the BIOS Recovery instructions below for BIOS recovery when the main BIOS boot crashes. However, when the BIOS boot block crashes, you will need to follow the procedures in Appendix D.

C-3 To Recover the Main BIOS Block Using a USB-Attached Device

This feature allows the user to recover a BIOS image using a USB-attached device without additional utilities used. A USB flash device such as a USB Flash Drive, or a USB CD/DVD ROM/RW device can be used for this purpose. However, a USB Hard Disk drive cannot be used for BIOS recovery at this time.

To perform UEFI BIOS recovery using a USB-attached device, follow the instructions below.

1. Using a different machine, copy the "Super.ROM" binary image file into the disc Root "\" Directory of a USB device or a writeable CD/DVD.



Note: If you cannot locate the "Super.ROM" file in your driver disk, visit our website at www.supermicro.com to download the BIOS image into a USB flash device and rename it "Super ROM" for BIOS recovery use.

2. Insert the USB device that contains the new BIOS image ("Super.ROM") into your USB drive and power on the system
3. While powering on the system, keep pressing <Ctrl> and <Home> simultaneously on your keyboard until you hear two short beeps. This may take from a few seconds to one minute.
4. After locating the new BIOS binary image, the system will enter the BIOS Recovery menu as shown below.



Note: At this point, you may decide if you want to start with BIOS Recovery. If you decide to proceed with BIOS Recovery, follow the procedures below.

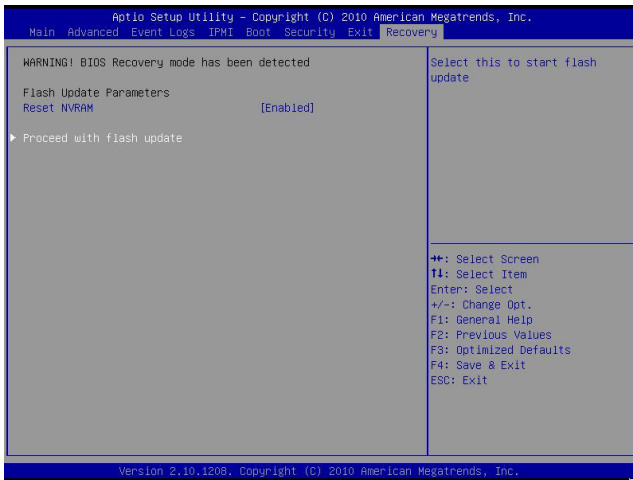

5. When the screen as shown above displays, using the arrow key, select the item- "Proceed with flash update" and press the <Enter> key. You will see the progress of BIOS Recovery as shown in the screen below.



Note: Do not interrupt the process of BIOS flashing until it is completed.

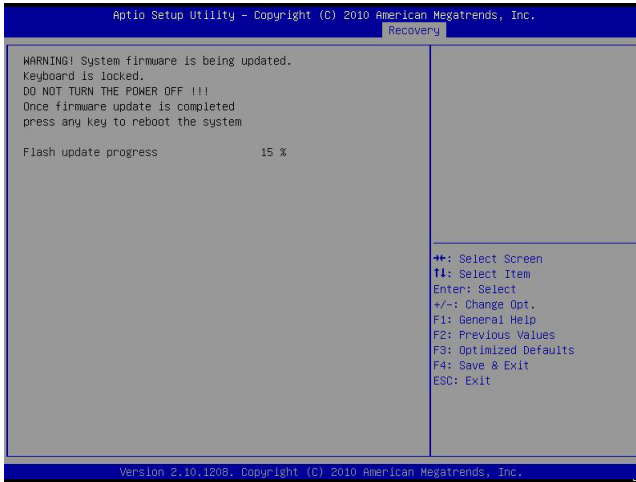

- After the process of BIOS Recovery is complete, press any key to reboot the system.

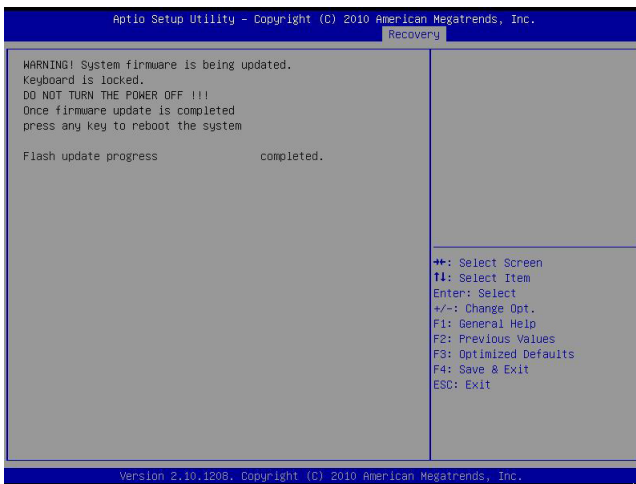

- Using a different system, extract the BIOS package into a bootable USB flash drive.
- When a DOS prompt appears, enter `AMI.BAT BIOSname.###` at the prompt.



Note: Do not interrupt this process until BIOS flashing is completed.

9. After seeing the message that BIOS update is completed, unplug the AC power cable from the power supply to clear CMOS, and then plug the AC power cable in the power supply again to power on the system.
10. Press continuously to enter the BIOS Setup utility.
11. Press <F3> to load default settings.
12. After loading default settings, press <F4> to save the settings and exit the BIOS Setup utility.

Appendix D

Dual Boot Block

D-1 Introduction

This motherboard supports the Dual Boot Block feature, which is the last-ditch mechanism to recover the BIOS boot block. This section provides an introduction to the feature.

BIOS Boot Block

A BIOS boot block is the minimum BIOS loader required to enable necessary hardware components for the BIOS crisis recovery flash that will update the main BIOS block. An on-call BIOS boot-block corruption may occur due to a software tool issue (see image below) or an unexpected power outage during BIOS updates.

```
-----  
                AMI Firmware Update Utility vX.XX.XX  
                Copyright (C)XXXX American Megatrends Inc. All Rights Reserved.  
-----  
Reading flash . . . . . done  
-- ME Data Size checking . ok  
-- FFS checksums . . . . . ok  
Erasing Boot Block . . . . . done  
_ Updating Boot Block . . . . . 0x00A91000 (13%)
```

BIOS Boot Block Corruption Occurrence

When a BIOS boot block is corrupted due to an unexpected power outage or a software tool malfunctioning during BIOS updates, you can still reboot the system by closing pins 2 and 3 using a cap on Jumper JBR1. When JBR1 is set to pins 2 and 3, the system will boot from a backup boot block pre-loaded in the BIOS by the manufacturer.

D-2 Steps to Reboot the System by Using Jumper JBR1 (Available when JBR1 is Installed onboard)

1. Power down the system.
2. Close pins 2-3 on Jumper JBR1, and power on the system.
3. Follow the BIOS recovery SOP listed in the previous chapter (Appendix C).
4. After completing the steps above, power down the system.
5. Close pins 1-2 on Jumper JBR1, and power on the system.

(Disclaimer Continued)

The products sold by Supermicro are not intended for and will not be used in life support systems, medical equipment, nuclear facilities or systems, aircraft, aircraft devices, aircraft/emergency communication devices or other critical systems whose failure to perform be reasonably expected to result in significant injury or loss of life or catastrophic property damage. Accordingly, Supermicro disclaims any and all liability, and should buyer use or sell such products for use in such ultra-hazardous applications, it does so entirely at its own risk. Furthermore, buyer agrees to fully indemnify, defend and hold Supermicro harmless for and against any and all claims, demands, actions, litigation, and proceedings of any kind arising out of or related to such ultra-hazardous use or sale.