

SUPER ®

SUPER  X8DT3

SUPER  X8DTi

SUPER  X8DT3-F

SUPER  X8DTi-F

SUPER  X8DT3-LN4F

SUPER  X8DTi-LN4F

USER'S MANUAL

Revision 1.2c

The information in this User's Manual has been carefully reviewed and is believed to be accurate. The vendor assumes no responsibility for any inaccuracies that may be contained in this document, makes no commitment to update or to keep current the information in this manual, or to notify any person or organization of the updates. **Please Note: For the most up-to-date version of this manual, please see our website at www.supermicro.com.**

Super Micro Computer, Inc. ("Supermicro") reserves the right to make changes to the product described in this manual at any time and without notice. This product, including software and documentation, is the property of Supermicro and/or its licensors, and is supplied only under a license. Any use or reproduction of this product is not allowed, except as expressly permitted by the terms of said license.

IN NO EVENT WILL SUPER MICRO COMPUTER, INC. BE LIABLE FOR DIRECT, INDIRECT, SPECIAL, INCIDENTAL, SPECULATIVE OR CONSEQUENTIAL DAMAGES ARISING FROM THE USE OR INABILITY TO USE THIS PRODUCT OR DOCUMENTATION, EVEN IF ADVISED OF THE POSSIBILITY OF SUCH DAMAGES. IN PARTICULAR, SUPER MICRO COMPUTER, INC. SHALL NOT HAVE LIABILITY FOR ANY HARDWARE, SOFTWARE, OR DATA STORED OR USED WITH THE PRODUCT, INCLUDING THE COSTS OF REPAIRING, REPLACING, INTEGRATING, INSTALLING OR RECOVERING SUCH HARDWARE, SOFTWARE, OR DATA.

Any disputes arising between manufacturer and customer shall be governed by the laws of Santa Clara County in the State of California, USA. The State of California, County of Santa Clara shall be the exclusive venue for the resolution of any such disputes. Supermicro's total liability for all claims will not exceed the price paid for the hardware product.

FCC Statement: This equipment has been tested and found to comply with the limits for a Class A digital device pursuant to Part 15 of the FCC Rules. These limits are designed to provide reasonable protection against harmful interference when the equipment is operated in a commercial environment. This equipment generates, uses, and can radiate radio frequency energy and, if not installed and used in accordance with the manufacturer's instruction manual, may cause harmful interference with radio communications. Operation of this equipment in a residential area is likely to cause harmful interference, in which case you will be required to correct the interference at your own expense.

California Best Management Practices Regulations for Perchlorate Materials: This Perchlorate warning applies only to products containing CR (Manganese Dioxide) Lithium coin cells. "Perchlorate Material-special handling may apply. See www.dtsc.ca.gov/hazardouswaste/perchlorate".

WARNING: Handling of lead solder materials used in this product may expose you to lead, a chemical known to the State of California to cause birth defects and other reproductive harm.

Manual Revision 1.2c

Release Date: March 9, 2012

Unless you request and receive written permission from Super Micro Computer, Inc., you may not copy any part of this document.

Information in this document is subject to change without notice. Other products and companies referred to herein are trademarks or registered trademarks of their respective companies or mark holders.

Copyright © 2012 by Super Micro Computer, Inc.
All rights reserved.

Printed in the United States of America

Preface

About this Manual

This manual is written for system integrators, PC technicians and knowledgeable PC users. It provides information for the installation and use of the **SUPER** X8DT3/X8DTi/X8DT3-F/X8DTi-F/X8DT3-LN4F/X8DTi-LN4F motherboard.

About this Motherboard

The **SUPER** X8DT3/X8DTi/X8DT3-F/X8DTi-F/X8DT3-LN4F/X8DTi-LN4F supports the Intel® 5500/5600* Series Processor platform, the first dual-processing platform that supports the Intel QuickPath Interconnect (QPI) Technology, providing the next generation point-to-point system interface to replace the current Front Side Bus. With the 5500/5600* Series Processor platform built in, the X8DT3/X8DTi/X8DT3-F/X8DTi-F/X8DT3-LN4F/X8DTi-LN4F offers substantial enhancement in system performance with increased bandwidth and unprecedented scalability optimized for high-end servers, High Performance Computing (HPC) systems and intensive applications. Please refer to our web site (<http://www.supermicro.com/products/>) for updates on supported processors. This product is intended to be installed and serviced by professional technicians. (*The 5600 Series processors are supported by a Rev. 2.00 or later version motherboard.)

Manual Organization

Chapter 1 describes the features, specifications and performance of the motherboard and provides detailed information about the chipset.

Chapter 2 provides hardware installation instructions. Read this chapter when installing the processor, memory modules and other hardware components into the system. If you encounter any problems, see **Chapter 3**, which describes troubleshooting procedures for video, memory and system setup stored in the CMOS.

Chapter 4 includes an introduction to the BIOS and provides detailed information on running the CMOS Setup utility.

Appendix A lists BIOS POST Error Codes. **Appendix B** provides Software Installation Instructions.

Conventions Used in the Manual

Special attention should be given to the following symbols for proper installation and to prevent damage done to the components or injury to yourself:



Danger/Caution: Instructions to be strictly followed to prevent catastrophic system failure or to avoid bodily injury.



Warning: Important information given to ensure proper system installation or to prevent damage to the components.



Note: Additional Information given to differentiate various models or to ensure correct system setup.

Contacting Supermicro

Headquarters

Address: Super Micro Computer, Inc.
980 Rock Ave.
San Jose, CA 95131 U.S.A.

Tel: +1 (408) 503-8000

Fax: +1 (408) 503-8008

Email: marketing@supermicro.com (General Information)
support@supermicro.com (Technical Support)

Web Site: www.supermicro.com

Europe

Address: Super Micro Computer B.V.
Het Sterrenbeeld 28, 5215 ML
's-Hertogenbosch, The Netherlands

Tel: +31 (0) 73-6400390

Fax: +31 (0) 73-6416525

Email: sales@supermicro.nl (General Information)
support@supermicro.nl (Technical Support)
rma@supermicro.nl (Customer Support)

Asia-Pacific

Address: Super Micro Computer, Inc.
4F, No. 232-1, Liancheng Rd.
Chung-Ho 235, Taipei County
Taiwan, R.O.C.

Tel: +886-(2) 8226-3990

Fax: +886-(2) 8226-3991

Web Site: www.supermicro.com.tw

Email: support@supermicro.com.tw (Technical Support)

Tel: +886-(2) 8226-5990 (Technical Support)

Table of Contents

Preface

Chapter 1 Introduction

1-1	Overview	1-1
1-3	Chipset Overview	1-9
1-4	Special Features	1-10
1-5	PC Health Monitoring	1-10
1-6	ACPI Features	1-11
1-7	Power Supply	1-12
1-8	Super I/O	1-12
1-9	Overview of the Winbond WPCM450 Controller (For X8DT3/i-F/X8DT3/i-LN4F Only)	1-13

Chapter 2 Installation

2-1	Static-Sensitive Devices	2-1
2-2	Motherboard Installation	2-2
2-3	Processor and Heatsink Installation	2-3
	Installing a CPU Heatsink	2-5
2-4	Memory Installation	2-7
2-5	Control Panel Connectors/IO Ports	2-12
	1. Back Panel Connectors/IO Ports	2-12
	ATX PS/2 Keyboard and PS/2 Mouse Ports	2-13
	Universal Serial Bus (USB)	2-14
	Serial Ports	2-15
	Video Connector	2-15
	Ethernet Ports	2-16
	2. Front Control Panel	2-17
	3. Front Control Panel Pin Definitions	2-18
	NMI Button	2-18
	Power LED	2-18
	HDD LED	2-19
	NIC1/NIC2 LED Indicators	2-19
	Overheat (OH)/Fan Fail LED	2-20
	Power Fail LED	2-20
	Reset Button	2-21
	Power Button	2-21
2-6	Connecting Cables	2-22
	Power Connectors	2-22
	Fan Headers	2-23

	Chassis Intrusion	2-23
	Internal Speaker	2-24
	Power LED/Speaker	2-24
	Wake-On-LAN	2-25
	Overheat LED/Fan Fail (JOH1).....	2-25
	T-SGPIO Headers	2-26
	I-Button (Optional for X8DT3/-F/LN4F only)	2-26
	Power SMB (I ² C) Connector	2-27
	IPMB I ² C SMB	2-27
	TPM Header	2-28
	DOM Power Connector	2-28
2-7	Jumper Settings	2-29
	Explanation of Jumpers	2-29
	GLAN Enable/Disable	2-29
	CMOS Clear	2-30
	Watch Dog Enable/Disable	2-30
	I ² C Bus to PCI-Exp. Slots	2-31
	VGA Enable.....	2-31
	SAS Enable/Disable (X8DT3/X8DT3-F/X8DT3-LN4F only).....	2-32
	SAS RAID Select (X8DT3/X8DT3-F/ X8DT3-LN4F only).....	2-32
	BMC Enable	2-33
2-8	Onboard LED Indicators	2-34
	GLAN LEDs.....	2-34
	IPMI Dedicated LAN LEDs (X8DT3/i-F/-LN4F Only)	2-34
	SAS Heartbeat/Activity LED Indicators	2-35
	BMC Heartbeat LED	2-35
	Onboard Power LED	2-36
2-9	Floppy Drive, Serial ATA and SAS Connections.....	2-37
	Floppy Connector.....	2-37
	Serial ATA Ports.....	2-38
	SAS Ports (X8DT3/X8DT3-F/X8DT3-LN4F only).....	2-38
Chapter 3 Troubleshooting		
3-1	Troubleshooting Procedures	3-1
	Before Power On	3-1
	No Power	3-1
	No Video	3-1
	Losing the System's Setup Configuration.....	3-2
	Memory Errors	3-2
3-2	Technical Support Procedures	3-2

3-3 Frequently Asked Questions 3-3
3-4 Returning Merchandise for Service..... 3-4

Chapter 4 BIOS

4-1 Introduction..... 4-1
 Starting BIOS Setup Utility..... 4-1
 How To Change the Configuration Data 4-2
 Starting the Setup Utility 4-2
4-2 Main Setup 4-2
4-3 Advanced Setup Configurations..... 4-4
4-4 Security Settings 4-24
4-5 Boot Configuration 4-26
4-6 Exit Options..... 4-27

Appendix A BIOS Error Beep Codes

A-1 BIOS Error Beep Codes A-1

Appendix B Software Installation Instructions

B-1 Installing Software Programs B-1
B-2 Configuring Supero Doctor III B-2

Chapter 1

Introduction

1-1 Overview

Checklist

Congratulations on purchasing your computer motherboard from an acknowledged leader in the industry. Supermicro boards are designed with the utmost attention to detail to provide the highest standards in quality and performance. Check that the following items have all been included with your motherboard. If anything listed here is damaged or missing, contact your retailer.

The following items are included in the retail box.

- One (1) Supermicro Mainboard
- One (1) floppy ribbon cable (CBL-0022L)
- One (1) USB cable (CBL-0083L)
- One (1) Serial/COM cable (CBL-010L)
- Four (4) Serial ATA cables (CBL-0044L) (For X8DT3/X8DT3-F/X8DT3-LN4F)
- Six (6) Serial ATA cables (CBL-0044L) (For X8DTi/X8DTi-F/X8DTi-LN4F)
- Two (2) SAS cable for SATA/SAS Backplane (CBL-0097L-02) (For X8DT3/X8DT3-F/X8DT3-LN4F)
- One (1) I/O backpanel shield (MCP-260-00027-0N)
- One (1) Supermicro CD containing drivers and utilities
- One (1) User's/BIOS Manual

SUPER X8DT3/X8DTi/X8DT3-F/X8DTi-F/X8DT3-LN4F/X8DTi-LN4F Image

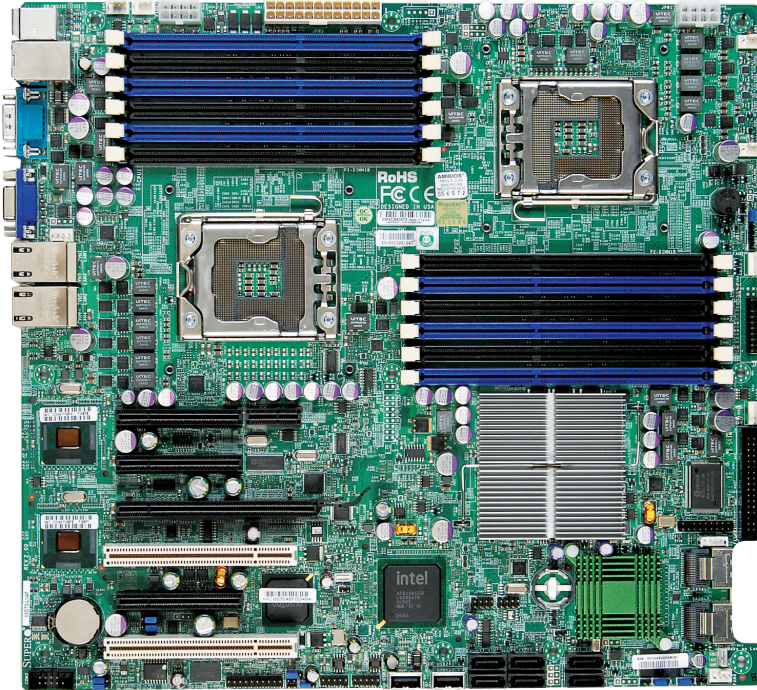

 **Note:** The drawings and pictures shown in this manual were based on the latest PCB Revision available at the time of publishing of the manual. The motherboard you've received may or may not look exactly the same as the graphics shown in the manual.

SUPER X8DT3/X8DTi/X8DT3-F/X8DTi-F/X8DT3-LN4F/X8DTi-LN4F Layout

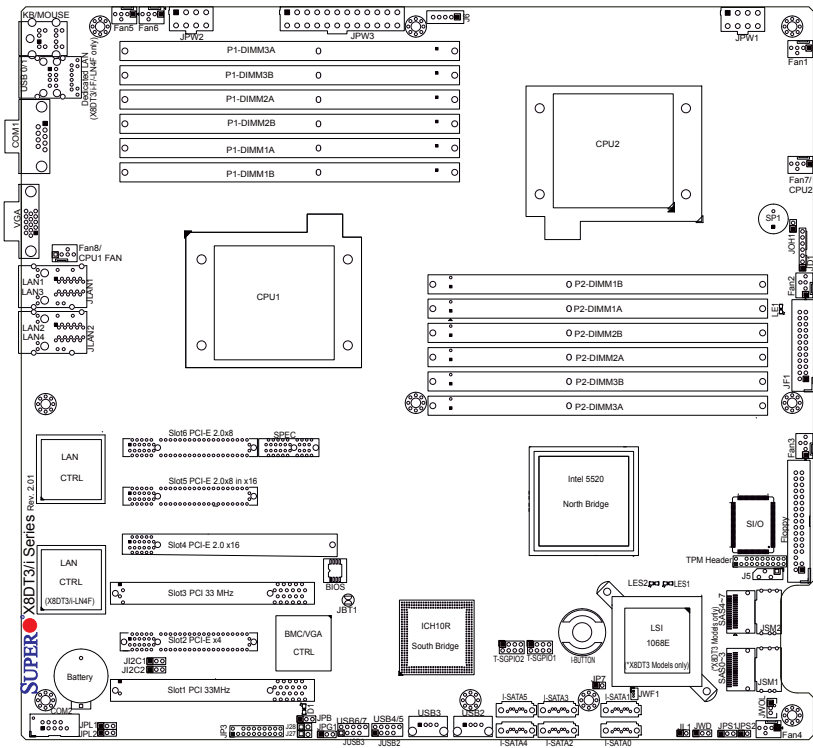

Motherboard Layout

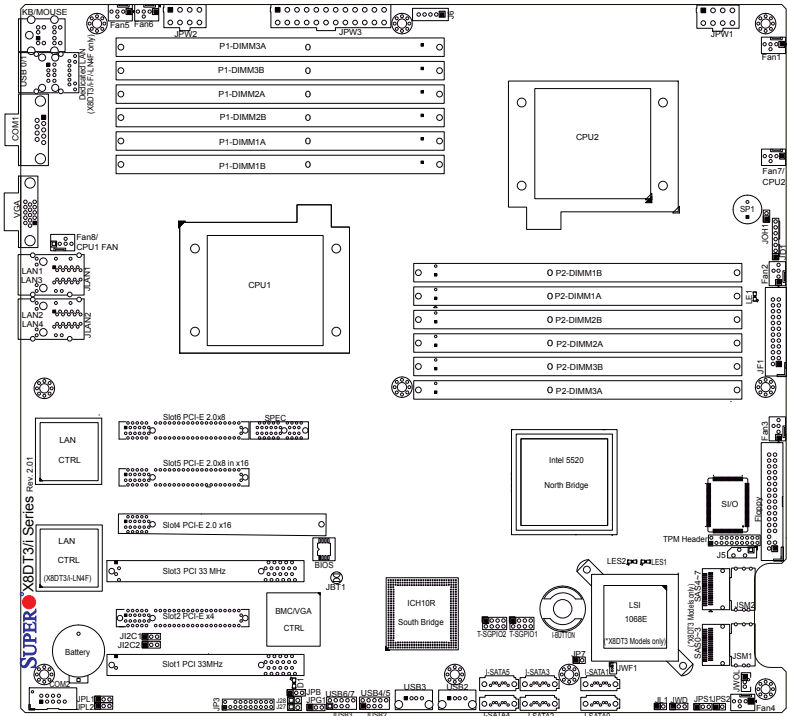

Notes:

1. Jumpers not indicated are for test purposes only.
2. For IPMI configuration, please refer to the Winbond BMC User's Guide posted on our website @ <http://www.supersmicro.com/support/manuals/>.
3. " " indicates the location of Pin 1. Also, refer to Chapter 2 for detailed information on the onboard components.
4. When LE1 is on, the onboard power connection is on. Make sure to unplug the power cables before removing or installing components.
5. To avoid possible system overheating, be sure to provide adequate airflow to the system.
6. JPB (BMC Enable jumper), JWF1 (DOM PWR connector), TPM (Trusted Platform Module header), the 5600 Series processors, and 1.35V DIMM modules are supported by the Rev. 2.00 or later version motherboard.

Quick Reference

Jumper	Description	Default Setting
JBT1	CMOS Clear	(See Section 5-10)
J ² C1/J ² C2	SMB to PCI Slots	2-3 (Disabled)
JPB	BMC Enable (for F models)	Pins 1-2 (Enabled) (for R. 2.00 & later board)
JPG1	VGA Enable	Pins 1-2 (Enabled)
JPL1/JPL2	LAN1/2 & LAN 3/4 Enable	Pins 1-2 (Enabled) (JP2: for LN4 models)
JPS1	SAS Enable	Pins 1-2 (Enabled) (Note 5 P. 1-4)
JPS2	SAS RAID Enable	Closed (SR RAID Enabled) (Note5 P1-4)
JWD	Watch Dog	Pins 1-2 (Reset)

Connector	Description
COM1/COM2	COM1/COM2 Serial Port/Header
FAN 1-8	System/CPU Fan Headers (Fans 7-8: CPU Fans)
Floppy	Floppy Disk Drive Connector
I-Button	I-Button for data storage (optional for X8DT3/-F/LN4F only)
J5	IPMB I ² C Header (for an IPMI card)
J6	Power Supply SMBbus I ² C Header
JD1	PWR LED/Speaker Header (Pins 4-7: Speaker)
JF1	Front Panel Connector
JL1	Chassis Intrusion Header
JOH1	Overheat LED Header
JWF1	DOM (Disk-On-Module) Power Header (for R. 2.0 & later)
JPW1/JPW2, JPW3	8-pin Secondary PWR, 24-pin ATX PWR (See Warning)
JWOL	Wake-On-LAN Header
LAN1/2, LAN 3/4, IPMI_Dedicated LAN	Gigabit Ethernet (RJ45) Ports (See Note 5 on P. 1-4)
I-SATA0 ~ I-SATA5	(Intel South Bridge) SATA Ports
SAS 0~3, 4~7	SAS Ports 0~3, 4~7 (X8DT3/-F/-LN4F only)
T-SGPIO-1/T-SGPIO-2	Serial General Purpose Input/Output Headers
TPM Header	Trusted Platform Module (TPM) Header (for R. 2.0 & later)
USB 0/1, 2,3, 4/5, 6/7	Universal Serial Bus (USB) Ports
VGA	VGA Connector

LED	Description
D1	BMC Heartbeat LED Indicator
LE1	Onboard Standby LED Indicator
LES1/LES2	SAS LEDs (LES1: SAS Heartbeat, LES2: SAS Activity LEDs)

 **Note:** To provide adequate power to the system, be sure to connect JPW1, JPW2 and JPW3 to the power supply. Refer to the warning on P. 1-12 for more information.

Motherboard Features

CPU

- Two Intel® 5500/5600* Series (LGA 1366) processors, each processor supporting two full-width Intel QuickPath Interconnect links with a total of up to 51.2 GB/s Data Transfer Rate (6.4 GB/s per direction)

Memory

- DIMM sockets support up to 192 GB of DDR3 Reg. ECC or up to 48 GB of DDR3 Unbuffered ECC/Non-ECC 1333 MHz/1066 MHz/800 MHz memory in 12 slots

Chipset

- Intel 5520 chipset, including: the 5520 (North Bridge) and the ICH10R (South Bridge).

Expansion Slots

- One PCI-E 2.0 x16 slot (Slot 4) (X8DTi/X8DTi-F only)
- Three PCI-E 2.0 x8 (in x16) slots (Slot 5/Slot 6, and Slot 4 for X8DT3/X8DT3-F/X8DTi/3-LN4 only)
- One PCI-E x4 slot (Slot 2) or Two PCI-E 2.0 x8 slots (for X8DTi/ X8DTi-F)
- Two 32-bit PCI 33 slot (Slot 1 and Slot 3)

BIOS

- 32 Mb AMI SPI Flash ROM
- PCI 2.2, ACPI 1.0/2.0/3.0, Plug and Play (PnP), DMI 2.3, Wakeup, USB Keyboard support, and SMBIOS 2.3

PC Health Monitoring

- Onboard voltage monitors for CPU1 Vcore/CPU2 Vcore, CPU1 DIMM/CPU2 DIMM, 1.5V, 3.3Vcc (V), 3.3V SB (V), 12Vcc (V), 5Vin, and Battery Voltage.
- Fan status monitor with firmware control
- CPU/chassis temperature monitors
- Platform Environment Control Interface (PECI) ready
- Thermal Monitor 2 (TM2) support
- CPU fan auto-off in sleep mode
- CPU slow-down on temperature overheat
- Pulse Width Modulation (PWM) Fan Control
- CPU thermal trip support for processor protection, power LED
- Power-up mode control for recovery from AC power loss
- Auto-switching voltage regulator for CPU cores
- System overheat/Fan Fail LED Indicator and control
- Chassis intrusion detection

- System resource alert via Supero Doctor III

ACPI Features

- Slow blinking LED for suspend state indicator
- Main switch override mechanism
- ACPI Power Management
- Keyboard Wakeup from Soft-off

Onboard I/O

- Intel ICH10R supports six SATA2 ports (with RAID0, RAID1, RAID10, RAID5 supported in the Windows OS Environment) (Note 1)
- LSI 1068E supports eight SAS ports (with RAID 5 optional) (For X8DT3/i-F/-LN4F) (Note 2)
- Intel 82576EB dual-port Gigabit Ethernet controllers support Giga-bit LAN ports (an additional 82576EB is available on the X8DT3/i-LN4F only)
- One floppy port interface and two COM ports (1 header, 1 port)
- One VGA Port supported by the WPCM450 BMC Controller
- PS/2 mouse and PS/2 keyboard ports
- Up to eight USB 2.0 (Universal Serial Bus) (2 Backpanel USB Ports, 2 Front USB Headers, and 2 Type A Headers)
- Super I/O: Winbond W83627HG
- IPMI 2.0 with full KVM support (X8DT3/i-F/-LN4F only) (Note 3)

Other

- Wake-on-LAN (WOL)
- Console redirection
- Onboard Fan Speed Control by Thermal Management via BIOS

CD/Diskette Utilities

- BIOS flash upgrade utility and device drivers

Dimensions

- Ext. ATX 12.00" (L) x 13.00" (W) (304.80 mm x 330.20 mm)



Note 1: For SATA HostRAID configuration instructions, please refer to the Intel SATA HostRAID User's Guide posted at <http://www.supermicro.com/support/manuals/>.

Note 2: For LSI SAS RAID configuration instructions, please refer to the LSI MegaRAID User's Guide posted at <http://www.supermicro.com/support/manuals/>.

Note 3: For IPMI configuration instructions, refer to the Embedded IPMI User's Guide posted at <http://www.supermicro.com/support/manuals/>.

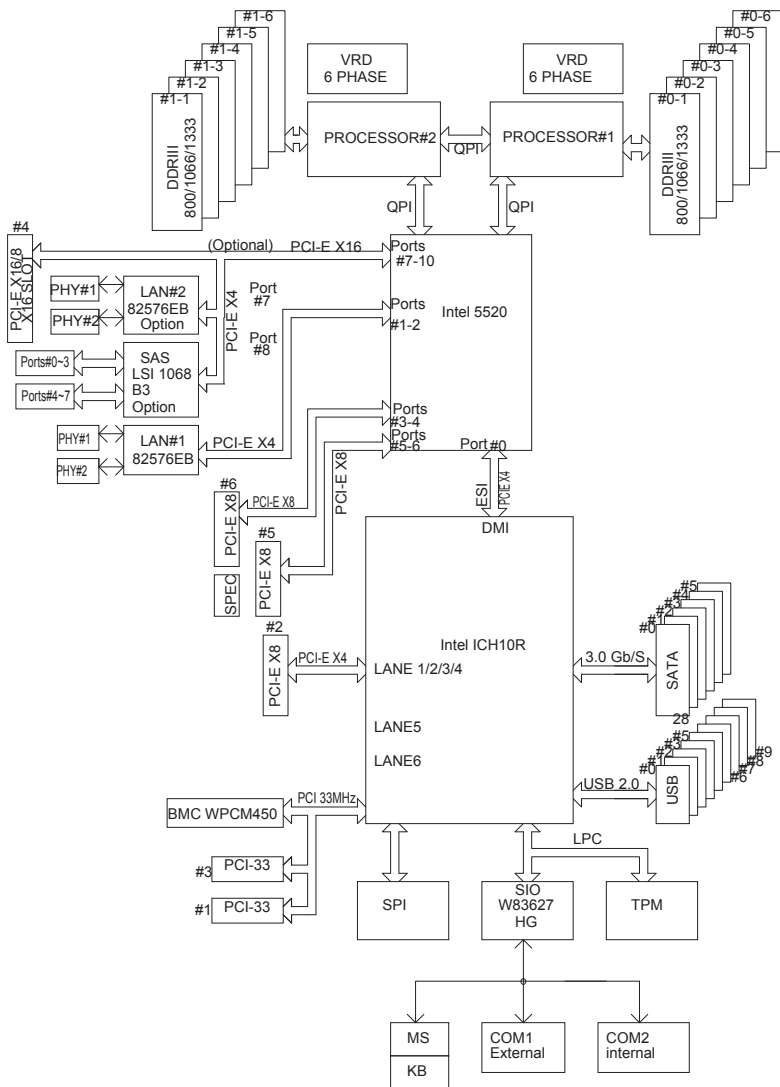

Block Diagram of the 5520 Platform

 **Note:** This is a general block diagram. Please see the previous Motherboard Features pages for details on the features of each motherboard.

1-3 Chipset Overview

Built upon the capability of the Intel 5520 platform, the X8DT3/X8DTi/X8DT3-F/X8DTi-F/X8DT3-LN4F/X8DTi-LN4F motherboard provides the performance and feature set required for dual-processor-based high-end systems with configuration optimized for workstations, High Performance Computing (HPC) systems, and intensive applications. The 5520 platform consists of the 5500/5600 Series (LGA 1366) processor, the 5520 (North Bridge), and the ICH10R (South Bridge). With the QuickPath Interconnect (QPI) controller built in, the 5520 platform is the first dual-processing platform that offers the next generation point-to-point system interconnect interface to replace the current Front Side Bus Technology, substantially enhancing system performance with increased bandwidth and scalability.

The 5520 North Bridge connects to each processor through an independent QuickPath Interconnect link. Each link consists of 20 pairs of unidirectional differential lanes for data transferring in addition to a differential forwarded clock. A full-width QuickPath interconnect link pair provides 84 signals. Each processor supports two QuickPath links, one going to the other processor and the other to the 5520.

The 5520 platform supports up to 36 PCI Express Gen2 lanes, peer-to-peer read and write transactions. The ICH10R provides up to 6 PCI-Express ports, six SATA ports and 10 USB connections.

In addition, the 5520 platform also offers a wide range of RAS (Reliability, Availability and Serviceability) features. These features include memory interface ECC, x4/x8 Single Device Data Correction (SDDC), Cyclic Redundancy Check (CRC), parity protection, out-of-band register access via SMBus, memory mirroring, and memory sparing.

Main Features of the 5500/5600 Series Processor and the 5520 Chipset

- Four processor cores in each processor with 8MB shared cache among cores
- Two full-width Intel QuickPath interconnect links, up to 6.4 GT/s of data transfer rate in each direction
- Virtualization Technology, Integrated Management Engine supported
- Point-to-point cache coherent interconnect, Fast/narrow unidirectional links, and Concurrent bi-directional traffic
- Error detection via CRC and Error correction via Link level retry

1-4 Special Features

Recovery from AC Power Loss

BIOS provides a setting for you to determine how the system will respond when AC power is lost and then restored to the system. You can choose for the system to remain powered off (in which case you must press the power switch to turn it back on) or for it to automatically return to a power-on state. See the Advanced BIOS Setup section to change this setting. The default setting is **Last State**.

1-5 PC Health Monitoring

This section describes the PC health monitoring features of the X8DT3/X8DTi/X8DT3-F/X8DTi-F/X8DT3-LN4F/X8DTi-LN4F. All have an onboard System Hardware Monitor chip that supports PC health monitoring. An onboard voltage monitor will scan these onboard voltages continuously: CPU1 Vcore/CPU2 Vcore, CPU1 DIMM/CPU2 DIMM, 1.5V, 3.3Vcc (V), 3.3V SB (V), 12Vcc (V), 5Vin, and Battery Voltage. Once a voltage becomes unstable, a warning is given or an error message is sent to the screen. Users can adjust the voltage thresholds to define the sensitivity of the voltage monitor.

Fan Status Monitor with Firmware Control

The PC health monitor can check the RPM status of the cooling fans. The onboard CPU and chassis fans are controlled by Thermal Management via BIOS (under Hardware Monitoring in the Advanced Setting).

Environmental Temperature Control

The thermal control sensor monitors the CPU temperature in real time and will turn on the thermal control fan whenever the CPU temperature exceeds a user-defined threshold. The overheat circuitry runs independently from the CPU. Once it detects that the CPU temperature is too high, it will automatically turn on the thermal fan control to prevent any overheat damage to the CPU. The onboard chassis thermal circuitry can monitor the overall system temperature and alert users when the chassis temperature is too high.



Warning: To avoid possible system overheating, please be sure to provide adequate airflow to your system.

System Resource Alert

This feature is available when used with Supero Doctor III in the Windows OS

environment or used with Supero Doctor II in Linux. Supero Doctor is used to notify the user of certain system events. For example, you can also configure Supero Doctor to provide you with warnings when the system temperature, CPU temperatures, voltages and fan speeds go beyond a pre-defined range.

1-6 ACPI Features

ACPI stands for Advanced Configuration and Power Interface. The ACPI specification defines a flexible and abstract hardware interface that provides a standard way to integrate power management features throughout a PC system, including its hardware, operating system and application software. This enables the system to automatically turn on and off peripherals such as CD-ROMs, network cards, hard disk drives and printers.

In addition to enabling operating system-directed power management, ACPI provides a generic system event mechanism for Plug and Play and an operating system-independent interface for configuration control. ACPI leverages the Plug and Play BIOS data structures while providing a processor architecture-independent implementation that is compatible with the Windows XP/2003/2008/Vista Operating System.

Slow Blinking LED for Suspend-State Indicator

When the CPU goes into a suspend state, the chassis power LED will start blinking to indicate that the CPU is in suspend mode. When the user presses any key, the CPU will wake-up and the LED will automatically stop blinking and remain on.

Main Switch Override Mechanism

When an ATX power supply is used, the power button can function as a system suspend button to make the system enter a SoftOff state. The monitor will be suspended and the hard drive will spin down. Pressing the power button again will cause the whole system to wake-up. During the SoftOff state, the ATX power supply provides power to keep the required circuitry in the system "alive." In case the system malfunctions and you want to turn off the power, just press and hold the power button for 4 seconds. This option can be set in the Power section of the BIOS Setup routine.

Wake-On-LAN (WOL)

Wake-On-LAN is defined as the ability of a management application to remotely power up a computer that is powered off. Remote PC setup, up-dates and asset tracking can occur after hours and on weekends so that daily LAN traffic is kept to a minimum and users are not interrupted. The motherboard has a 3-pin header

(WOL) to connect to the 3-pin header on a Network Interface Card (NIC) that has WOL capability. In addition, an onboard LAN controller can also support WOL without any connection to the WOL header. The 3-pin WOL header is to be used with a LAN add-on card only.



Note: Wake-On-LAN requires an ATX 2.01 (or above) compliant power supply.

1-7 Power Supply

As with all computer products, a stable power source is necessary for proper and reliable operation. It is even more important for processors that have high CPU clock rates.

The X8DT3/X8DTi/X8DT3-F/X8DTi-F/X8DT3-LN4F/X8DTi-LN4F can accommodate 24-pin ATX power supplies. Although most power supplies generally meet the specifications required by the CPU, some are inadequate. In addition, the two 12V 8-pin power connections are also required to ensure adequate power supply to the system. Also your power supply must supply 1.5A for the Ethernet ports.



Warning: To prevent damage to the power supply or motherboard, please use a power supply that contains a 24-pin and two 8-pin power connectors. Be sure to connect these connectors to the 24-pin (JPW3) and the two 8-pin (JPW1,JPW2) power connectors on the motherboard for adequate power supply to your system. Failure in doing so will void the manufacturer warranty on your power supply and motherboard.

It is strongly recommended that you use a high quality power supply that meets ATX power supply Specification 2.02 or above. It must also be SSI compliant (For more information, please refer to the web site at <http://www.ssiforum.org/>). Additionally, in areas where noisy power transmission is present, you may choose to install a line filter to shield the computer from noise. It is recommended that you also install a power surge protector to help avoid problems caused by power surges.

1-8 Super I/O

The disk drive adapter functions of the Super I/O chip include a floppy disk drive controller that is compatible with industry standard 82077/765, a data separator, write pre-compensation circuitry, decode logic, data rate selection, a clock generator, drive interface control logic and interrupt and DMA logic. The wide range of functions integrated onto the Super I/O greatly reduces the number of components required for interfacing with floppy disk drives. The Super I/O supports 360 K, 720 K, 1.2 M, 1.44 M or 2.88 M disk drives and data transfer rates of 250 Kb/s, 500 Kb/s or 1 Mb/s. It also provides two high-speed, 16550 compatible serial communication

ports (UARTs). Each UART includes a 16-byte send/receive FIFO, a programmable baud rate generator, complete modem control capability and a processor interrupt system. Both UARTs provide legacy speed with baud rate of up to 115.2 Kbps as well as an advanced speed with baud rates of 250 K, 500 K, or 1 Mb/s, which support higher speed modems.

The Super I/O provides functions that comply with ACPI (Advanced Configuration and Power Interface), which includes support of legacy and ACPI power management through an SMI or SCI function pin. It also features auto power management to reduce power consumption.

1-9 Overview of the Winbond WPCM450 Controller (For X8DT3/i-F/X8DT3/i-LN4F Only)

The Winbond WPCM450 Controller is a Baseboard Management Controller (BMC) that supports the 2D/VGA-compatible Graphics Core with the PCI interface, Virtual Media, and Keyboard/Video/Mouse Redirection (KVMR) modules. With blade-oriented Super I/O capability built-in, the WPCM450 Controller is ideal for legacy-reduced server platforms.

The WPCM450 interfaces with the host system via a PCI interface to communicate with the Graphics core. It supports USB 2.0 and 1.1 for remote keyboard/mouse/virtual media emulation. It also provides LPC interface to control Super IO functions. The WPCM450 is connected to the network via an external Ethernet Phy module.

The WPCM450 communicates with onboard components via six SMBus interfaces, fan control, and Platform Environment Control Interface (PECI) buses.

Notes

Chapter 2

Installation

2-1 Static-Sensitive Devices

Electrostatic Discharge (ESD) can damage electronic components. To prevent damage to your system board, it is important to handle it very carefully. The following measures are generally sufficient to protect your equipment from ESD.

Precautions

- Use a grounded wrist strap designed to prevent static discharge.
- Touch a grounded metal object before removing the board from the antistatic bag.
- Handle the board by its edges only; do not touch its components, peripheral chips, memory modules or gold contacts.
- When handling chips or modules, avoid touching their pins.
- Put the motherboard and peripherals back into their antistatic bags when not in use.
- For grounding purposes, make sure your computer chassis provides excellent conductivity between the power supply, the case, the mounting fasteners and the motherboard.
- Use only the correct type of onboard CMOS battery as specified by the manufacturer. Do not install the onboard battery upside down to avoid possible explosion.



Unpacking

The motherboard is shipped in antistatic packaging to avoid static damage. When unpacking the board, make sure the person handling it is static protected.

2-2 Motherboard Installation

All motherboards have standard mounting holes to fit different types of chassis. Make sure that the locations of all the mounting holes for both motherboard and chassis match. Although a chassis may have both plastic and metal mounting fasteners, metal ones are highly recommended because they ground the motherboard to the chassis. Make sure that the metal standoffs click in or are screwed in tightly. Then use a screwdriver to secure the motherboard onto the motherboard tray. Note: Some components are very close to the mounting holes. Please take precautionary measures to prevent damage to these components when installing the motherboard to the chassis.

Tools Needed

1. Phillips Screwdriver 
2. Pan head #6 screws 

Installation Instructions

1. Install the IO shield into the chassis.
2. Locate the mounting holes on the motherboard. Refer to the layout above for mounting hole locations.
3. Locate the matching mounting holes on the chassis. Align the mounting holes on the motherboard against the mounting holes on the chassis.
4. Install standoffs in the chassis as needed.
5. Install the motherboard into the chassis carefully to avoid damage to motherboard components.

 **Warning:** To avoid damaging the motherboard and its components, please do not apply any force greater than 8 *lb/sq.in* (8 lbs. per square inch) when installing a screw into a mounting hole.

6. Insert a Pan head #6 screw into a mounting hole on the motherboard and its matching mounting hole on the chassis, using a Phillips screwdriver.
7. Repeat Step 4 to insert #6 screws to all mounting holes.
8. Make sure that the motherboard is securely placed on the chassis.

Locations of Mounting Holes

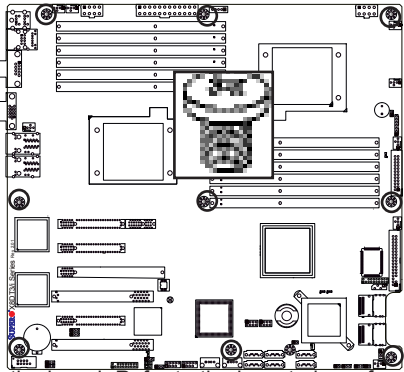

2-3 Processor and Heatsink Installation



Warning: When handling the processor package, avoid placing direct pressure on the label area of the fan.



Notes:

1. Always connect the power cord last and always remove it before adding, removing or changing any hardware components. Make sure that you install the processor into the CPU socket before you install the CPU heatsink.
2. Make sure to install the motherboard into the chassis before you install the CPU heatsink and heatsink fans.
3. When purchasing a 5500/5600 Series processor or when receiving a motherboard with a 5500/5600 Series processor pre-installed, make sure that the CPU plastic cap is in place, and none of the CPU pins are bent; otherwise, contact the retailer immediately.
4. Refer to the Motherboard Features Section for more details on CPU support.

1. Press the socket clip to release the load plate, which covers the CPU socket, from its locking position.
2. Gently lift the socket clip to open the load plate.
3. Hold the plastic cap at its north and south center edges to remove it from the CPU socket.



Socket Clip **Load Plate**

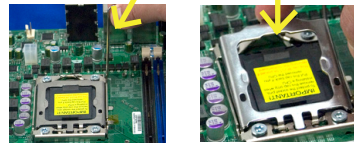

Plastic Cap

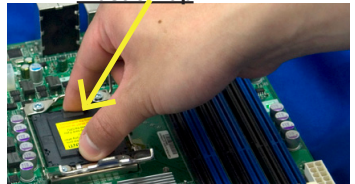

Hold the north & south edges of the plastic cap to remove it

1. After removing the plastic cap, using your thumb and the index finger, hold the CPU at the north and south center edges.
2. Align the CPU key, the semi-circle cutout, against the socket key, the notch below the gold color dot on the side of the socket.
3. Once both the CPU and the socket are aligned, carefully lower the CPU straight down into the socket. (Do not rub the CPU against the surface of the socket or its pins to avoid damaging the CPU or the socket.)
4. With the CPU inside the socket, inspect the four corners of the CPU to make sure that the CPU is properly installed.
5. Once the CPU is securely seated on the socket, lower the CPU load plate to the socket.
6. Use your thumb to gently push the socket clip down to the clip lock.

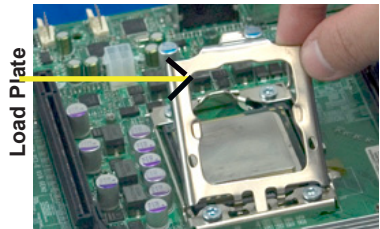
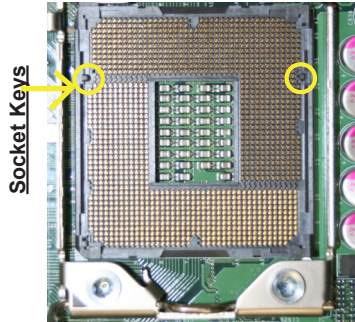
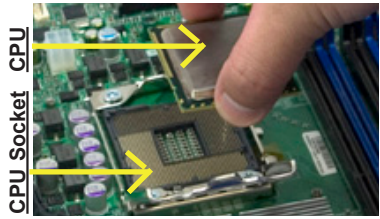

Warning: Please save the plastic cap. The motherboard must be shipped with the plastic cap properly installed to protect the CPU socket pins. Shipment without the plastic cap properly installed will cause damage to the socket pins.

Installing a CPU Heatsink

1. Do not apply any thermal grease to the heatsink or the CPU die because the required amount has already been applied.
2. Place the heatsink on top of the CPU so that the four mounting holes are aligned with those on the retention mechanism.
3. Install two diagonal screws (ie the #1 and the #2 screws) and tighten them until just snug (-do not fully tighten the screws to avoid possible damage to the CPU.)
4. Finish the installation by fully tightening all four screws.

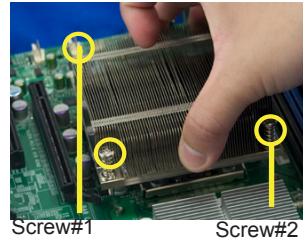
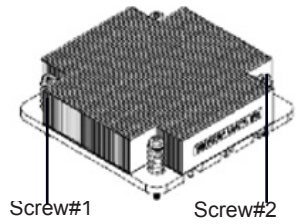

Install Screw#1

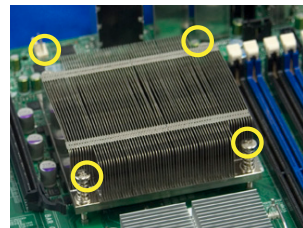
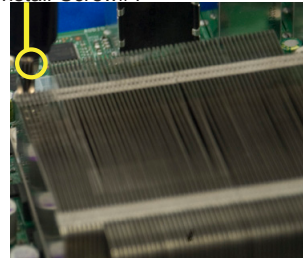

Removing the Heatsink



Warning: We do not recommend that the CPU or the heatsink be removed. However, if you do need to remove the heatsink, please follow the instructions below to uninstall the heatsink and prevent damage to the CPU or other components.

1. Unplug the power cord from the power supply.
2. Disconnect the heatsink fan wires from the CPU fan header.
3. Using a screwdriver, loosen and remove the heatsink screws from the motherboard in the sequence as show in the picture on the right.
4. Hold the heatsink as shown in the picture on the right and gently wriggle the heatsink to loosen it from the CPU. (Do not use excessive force when wriggling the heatsink.)
5. Once the CPU is loosened, remove the heatsink from the CPU socket.
6. To reinstall the CPU and the heatsink, clean the surface of the CPU and the heatsink to get rid of the old thermal grease. Reapply the proper amount of thermal grease on the surface before reinstalling them on the motherboard.

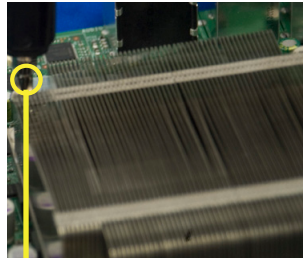

Using a screwdriver to remove Screw#1

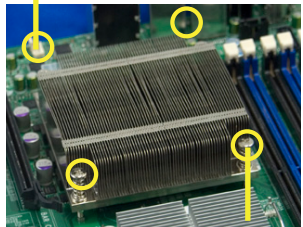

Remove Screw#2

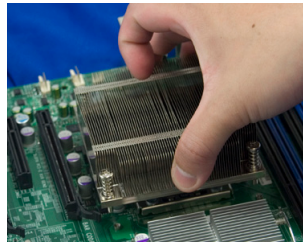

2-4 Memory Installation

Note: Check the Supermicro web site for recommended memory modules.

CAUTION



Exercise extreme care when installing or removing DIMM modules to prevent any possible damage. Also note that the memory is interleaved to improve performance (See step 1).

DIMM Installation

1. Insert the desired number of DIMMs into the memory slots, starting with DIMM #P1-DIMM1A. When populating two DIMM modules within a channel, always start with Bank1 first. For optimal memory performance, please install 3 memory modules of the same type and same speed at a time with the maximum of 12 modules. (See the Memory Installation Tables on Pages 2-8, 2-9.)
2. Insert each DIMM module vertically into its slot. Pay attention to the notch along the bottom of the module to prevent inserting the DIMM module incorrectly.
3. Gently press down on the DIMM module until it snaps into place in the slot. Repeat for all modules.

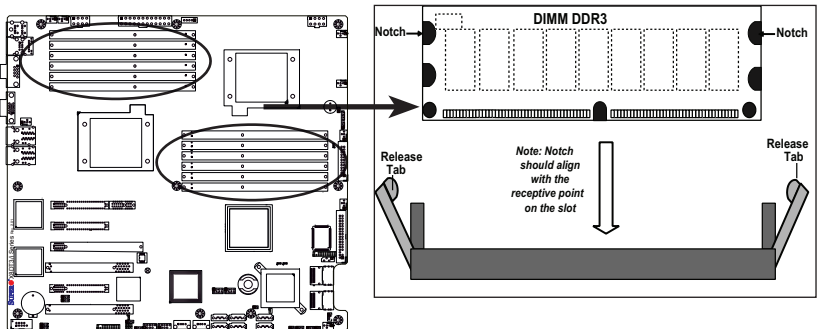

To Install: Insert module vertically and press down until it snaps into place. Pay attention to the alignment notch at the bottom.

To Remove:

Use your thumbs to gently push the release tabs near both ends of the module. This should release it from the slot.

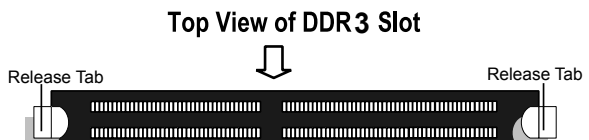

Memory Population for Optimal Performance -For a motherboard with One CPU (CPU1) installed						
	Branch 0		Branch 1		Branch 2	
3 DIMMs	P1 DIMM1A		P1 DIMM2A		P1 DIMM3A	
6 DIMMs	P1 DIMM1A	P1 DIMM1B	P1 DIMM2A	P1 DIMM2B	P1 DIMM3A	P1 DIMM3B

Memory Population for Optimal Performance -For a motherboard with One CPU (CPU2) installed						
	Branch 0		Branch 1		Branch 2	
3 DIMMs	P2 DIMM1A		P2 DIMM2A		P2 DIMM3A	
6 DIMMs	P2 DIMM1A	P2 DIMM1B	P2 DIMM2A	P2 DIMM2B	P2 DIMM3A	P2 DIMM3B

Memory Population for Optimal Performance -For a motherboard with Two CPUs installed												
	CPU1						CPU2					
	Branch 0		Branch 1		Branch 3		Branch 0		Branch 1		Branch 3	
6 DIMMs	1A		2A		3A		1A		2A		3A	
12 DIMMs	1A	1B	2A	2B	3A	3B	1A	1B	2A	2B	3A	3B

Memory Support

The X8DT3/X8DTi/X8DT3-F/X8DTi-F/X8DT3-LN4F/X8DTi-LN4F supports up to 192 GB Registered ECC DDR3 or up to 48 GB Unbuffered ECC/Non-ECC 1333 MHz/1066 MHz/800 MHz in 12 DIMMs. Please note that Memory Speed support depends on the type of CPU used in the motherboard.

DIMM Module Population Configuration

For memory to work properly, follow the tables below for memory installation.

Memory Support for the motherboards w/5500 Series Processors installed

RDIMM Population for the Motherboard w/5500 Processors Installed				
DIMM Slots per Channel	DIMMs Populated per Channel	DIMM Type (Reg.= Registered)	Speeds (in MHz)	Ranks per DIMM (any combination; SR=Single Rank, DR=Dual Rank, QR=Quad Rank)
2	1	Reg. DDR3 ECC	800,1066,1333	SR or DR
2	1	Reg. DDR3 ECC	800,1066	QR
2	2	Reg. DDR3 ECC	800,1066	Mixing SR, DR
2	2	Reg. DDR3 ECC	800	Mixing SR, DR, QR

UDIMM Population for the Motherboard w/5500 Processors Installed				
DIMM Slots per Channel	DIMMs Populated per Channel	DIMM Type (Unb.= Unbuffered)	Speeds (in MHz)	Ranks per DIMM (Mixing: any combination; SR=Single Rank, DR=Dual Rank)
2	1	Unb. ECC/NON-ECC DDR3	800,1066,1333	SR or DR
2	2	Unb. ECC/NON-ECC DDR3 (Note)	800,1066	Mixing SR, DR
Note: 1333 MHz RDIMMs will run at 1066 MHz (-BIOS automatic downgrading).				

Memory Support for the Motherboards w/5600 Processors Installed

- 1.5V DIMMs

1.5V RDIMM Population for the Motherboard w/5600 Processors Installed				
DIMM Slots per Channel	DIMMs Populated per Channel	DIMM Type (Reg.=Registered)	Speeds (in MHz)	Ranks per DIMM (any combination; SR=Single Rank, DR=Dual Rank, QR=Quad Rank)
2	1	Reg. DDR3 ECC	800,1066,1333	SR or DR
2	1	Reg. DDR3 ECC	800,1066 (Note 1)	QR
2	2	Reg. DDR3 ECC	800,1066, 1333	Mixing SR, DR
2	2	Reg. DDR3 ECC	800 (Note 2)	Mixing SR, DR, QR
Note 1: 1333 MHz RDIMMs will run at 1066 MHz (-BIOS automatic downgrading).				
Note 2: 1333/1066 MHz RDIMMs will run at 800 MHz (-BIOS automatic downgrading).				

1.5V UDIMM Population for the Motherboard w/5600 Processors Installed				
DIMM Slots per Channel	DIMMs Populated per Channel	DIMM Type (Unb.= Unbuffered)	Speeds (in MHz)	Ranks per DIMM (any combination; SR=Single Rank, DR=Dual Rank, QR=Quad Rank)
2	1	Unb. DDR3 ECC/Non-ECC	800,1066,1333	SR or DR
2	2	Unb. DDR3 ECC/Non-ECC	800,1066, 1333	Mixing SR, DR
Note 1: 1333 MHz for two DIMMs per channel is supported when Unbuf./ECC DIMMs are used.				
Note 2: Mixing of 1.35V and 1.5V DIMMs is not recommended.				

- 1.35V DIMMs

1.35V RDIMM Population for the Motherboard w/5600 Processors Installed				
DIMM Slots per Channel	DIMMs Populated per Channel	DIMM Type (Reg.=Registered)	Speeds (in MHz)	Ranks per DIMM (any combination; SR=Single Rank, DR=Dual Rank, QR=Quad Rank)
2	1	Reg. DDR3 ECC	800,1066,1333	SR or DR
2	1	Reg. DDR3 ECC	800 (Note 1)	QR
2	2	Reg. DDR3 ECC	800,1066 (Note 2)	Mixing SR, DR
2	2	Reg. DDR3 ECC	800 (Note 3)	Mixing SR, DR, QR

Note 1: 1333/1066 MHz QR RDIMMs will run at 800 MHz (-BIOS automatic downgrading).
Note 2: 1333 MHz SR/DR RDIMMs will run at 800 MHz (-BIOS automatic downgrading).
Note 3: 1333/1066 MHz SR/DR/QR RDIMMs will run at 800 MHz (-BIOS automatic downgrading).
Note 4: Mixing of 1.35V and 1.5V DIMMs is not recommended.

1.35V UDIMM Population for the Motherboard w/5600 Processors Installed				
DIMM Slots per Channel	DIMMs Populated per Channel	DIMM Type (Unb.=Unbuffered)	Speeds (in MHz)	Ranks per DIMM (any combination; SR=Single Rank, DR=Dual Rank, QR=Quad Rank)
2	1	Unb. DDR3 ECC	800,1066,1333	SR or DR
2	2	Unb. DDR3 ECC	800,1066	Mixing SR, DR

Note 1: 1333 MHz for two DIMMs per channel is supported when Unbuf./ECC DIMMs are used.
Note 2: Mixing of 1.35V and 1.5V DIMMs is not recommended.



Note 1: Due to OS limitations, some operating systems may not show more than 4 GB of memory.

Note 2: Due to memory allocation to system devices, the amount of memory that remains available for operational use will be reduced when 4 GB of RAM is used. The reduction in memory availability is disproportional. (See the following Memory Availability Table.)

Possible System Memory Allocation & Availability		
System Device	Size	Physical Memory Remaining (-Available) (4 GB Total System Memory)
Firmware Hub flash memory (System BIOS)	1 MB	3.99 GB
Local APIC	4 KB	3.99 GB
Area Reserved for the chipset	2 MB	3.99 GB
I/O APIC (4 Kbytes)	4 KB	3.99 GB
PCI Enumeration Area 1	256 MB	3.76 GB
PCI Express (256 MB)	256 MB	3.51 GB
PCI Enumeration Area 2 (if needed) -Aligned on 256-MB boundary-	512 MB	3.01 GB
VGA Memory	16 MB	2.85 GB
TSEG	1 MB	2.84 GB
Memory available for the OS & other applications		2.84 GB

2-5 Control Panel Connectors/IO Ports

The I/O ports are color coded in conformance with the PC 99 specification. See the picture below for the colors and locations of the various I/O ports.

1. Back Panel Connectors/IO Ports

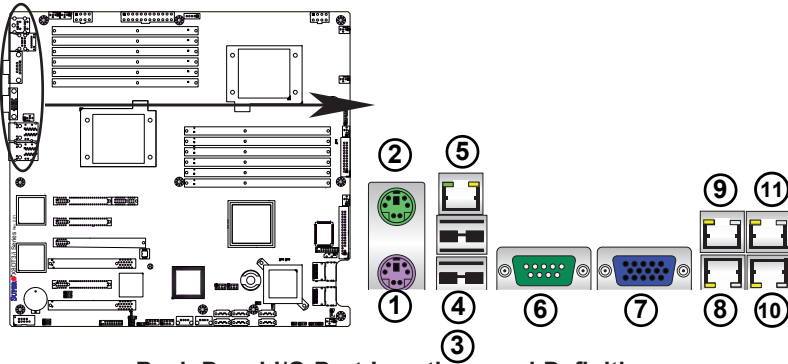

Back Panel I/O Port Locations and Definitions

Back Panel Connectors

1. Keyboard (Purple)
2. PS/2 Mouse (Green)
3. Back Panel USB Port 0
4. Back Panel USB Port 1
5. Dedicated LAN (X8DT3/i-F/ X8DT3/i-LN4F only)
6. COM Port 1 (Turquoise)
7. VGA (Blue)
8. Gigabit LAN 1
9. Gigabit LAN 3 (for X8DT3-LN4F/X8DTi-LN4F only)
10. Gigabit LAN 2
11. Gigabit LAN 4 (for X8DT3-LN4F/X8DTi-LN4F only)(See Section 2-5 for details.)

ATX PS/2 Keyboard and PS/2 Mouse Ports

The ATX PS/2 keyboard and PS/2 mouse are located next to the Back Panel USB Ports 0~1 on the motherboard. See the table at right for pin definitions.

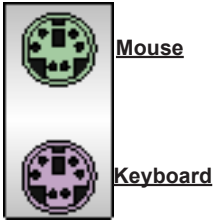

PS/2 Keyboard/Mouse Pin Definitions			
PS2 Keyboard		PS2 Mouse	
Pin#	Definition	Pin#	Definition
1	KB Data	1	Mouse Data
2	No Connection	2	No Connection
3	Ground	3	Ground
4	Mouse/KB VCC (+5V)	4	Mouse/KB VCC (+5V)
5	KB Clock	5	Mouse Clock
6	No Connection	6	No Connection

VCC: with 1.5A PTC (current limit)

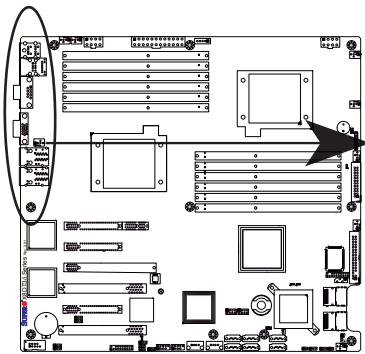

1. Keyboard (Purple)

2. Mouse (Green)

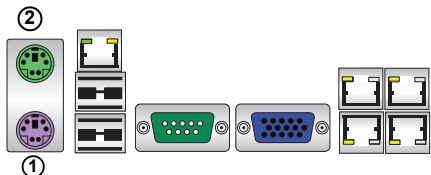

Universal Serial Bus (USB)

Two Universal Serial Bus ports (USB 0 and USB 1) are located on the I/O back panel. Additionally, six USB connections (USB 2, 3, 4/5, 6/7) on the motherboard to provide front chassis access. (Cables are not included). See the tables on the right for pin definitions.

Back Panel USB (USB 0/1)	
Pin#	Definitions
1	+5V
2	PO-
3	PO+
4	Ground
5	N/A

Front Panel USB (USB 2/3)	
Pin#	Definition
1	Vcc
2	Data-
3	Data+
4	Ground
5	NA

Front Panel USB Pin Definitions (USB4/5/6/7)			
USB 4/6		USB 5/7	
Pin #	Definition	Pin #	Definition
1	+5V	1	+5V
2	PO-	2	PO-
3	PO+	3	PO+
4	Ground	4	Ground
5	Key	5	No connection

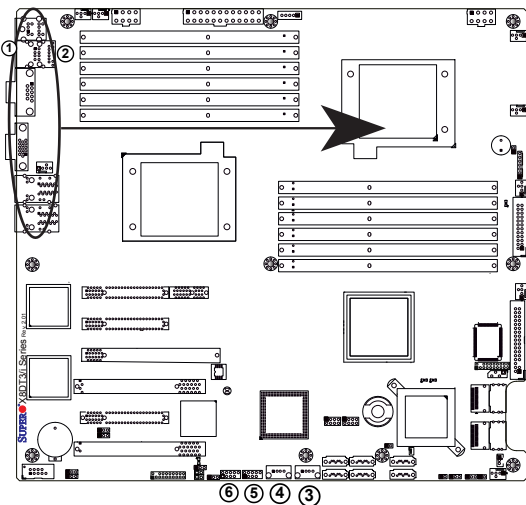

1. Backpanel USB 0
2. Backpanel USB 1
3. Front Panel USB 2
4. Front Panel USB 3
5. Front Panel USB 4/5
6. Front Panel USB 6/7

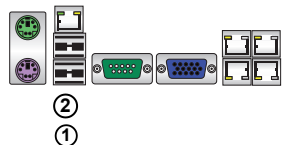

Serial Ports

Two COM connections (COM1 & COM2) are located on the motherboard. COM1 is located on the Backplane IO panel. COM2 is located next to the onboard battery to provide additional onboard serial connection support. See the table on the right for pin definitions.

Serial Ports-COM1/COM2 Pin Definitions			
Pin #	Definition	Pin #	Definition
1	DCD	6	DSR
2	RXD	7	RTS
3	TXD	8	CTS
4	DTR	9	RI
5	Ground	10	N/A

Video Connector

A Video (VGA) connector is located next to COM Port1 on the IO backplane. This connector is used to provide video display. Refer to the board layout below for the location.

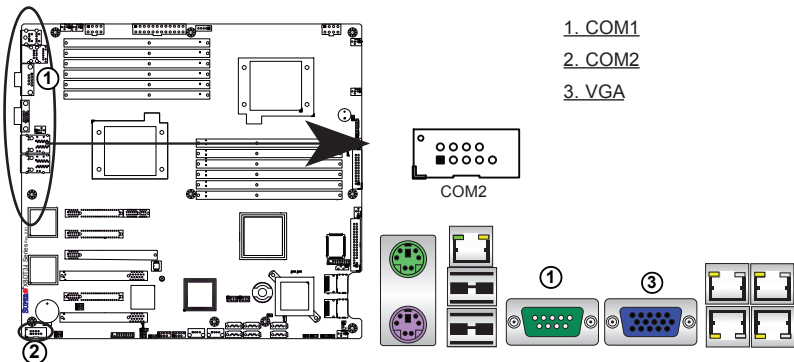

Ethernet Ports

Two Ethernet ports (LAN 1/LAN2) are located at on the IO backplane. In addition, LAN 3/LAN4 are supported on the X8DT3/i-LN4F. A dedicated LAN is also located on the X8DT3/i-F/ X8DT3/i-LN4F to provide KVM support for IPMI 2.0. All these ports accept RJ45 type cables. **(Note:** Please refer to the LED Indicator Section for LAN LED information.)

LAN Ports Pin Definition			
Pin#	Definition		
1	P2V5SB	10	SGND
2	TD0+	11	Act LED
3	TD0-	12	P3V3SB
4	TD1+	13	Link 100 LED (Yellow, +3V3SB)
5	TD1-	14	Link 1000 LED (Yellow, +3V3SB)
6	TD2+	15	Ground
7	TD2-	16	Ground
8	TD3+	17	Ground
9	TD3-	88	Ground

(NC: No Connection)

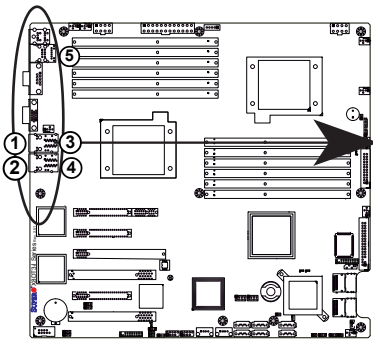

- 1. LAN1
- 2. LAN2
- 3. LAN3 (X8DT3/i-LN4F only)
- 4. LAN4 (X8DT3/i-LN4F only)
- 5. LAN5 (X8DT3/i-F/-LN4F only)

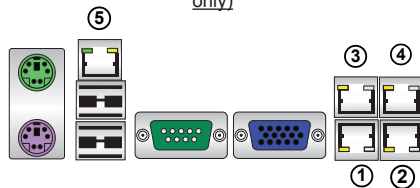

2. Front Control Panel

JF1 contains header pins for various buttons and indicators that are normally located on a control panel at the front of the chassis. These connectors are designed specifically for use with Supermicro server chassis. See the figure below for the descriptions of the various control panel buttons and LED indicators. Refer to the following section for descriptions and pin definitions.

JF1 Header Pins

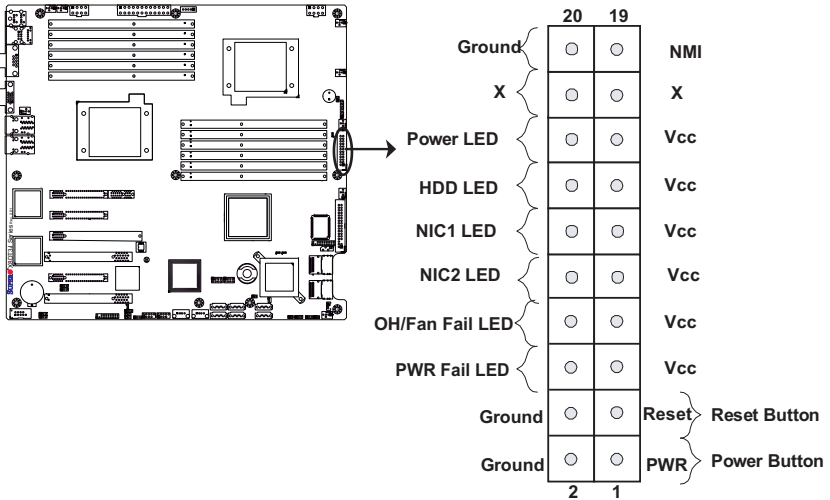

3. Front Control Panel Pin Definitions

NMI Button

The non-maskable interrupt button header is located on pins 19 and 20 of JF1. Refer to the table on the right for pin definitions.

NMI Button Pin Definitions (JF1)	
Pin#	Definition
19	Control
20	Ground

Power LED

The Power LED connection is located on pins 15 and 16 of JF1. Refer to the table on the right for pin definitions.

Power LED Pin Definitions (JF1)	
Pin#	Definition
15	+5V
16	Ground

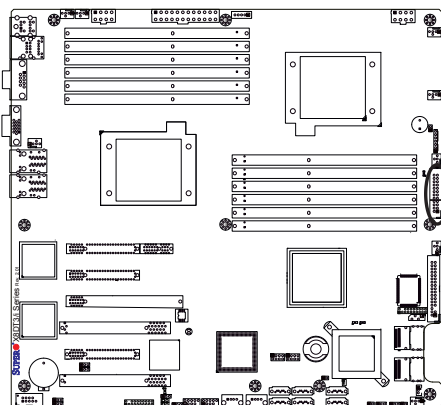

A. NMI

B. PWR LED

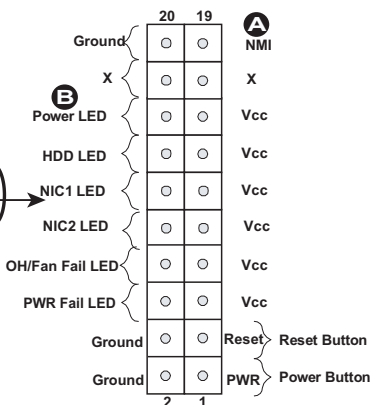

HDD LED

The HDD LED connection is located on pins 13 and 14 of JF1. Attach a hard drive LED cable here to display disk activity (for any hard drive activities on the system, including SAS, Serial ATA and IDE). See the table on the right for pin definitions.

HDD LED Pin Definitions (JF1)	
Pin#	Definition
13	+5V
14	HD Active

NIC1/NIC2 LED Indicators

The NIC (Network Interface Controller) LED connection for GLAN port 1 is located on pins 11 and 12 of JF1, and the LED connection for GLAN Port 2 is on Pins 9 and 10. Attach the NIC LED cables to display network activity. Refer to the table on the right for pin definitions.

GLAN1/2 LED Pin Definitions (JF1)	
Pin#	Definition
9/11	Vcc
10/12	Ground

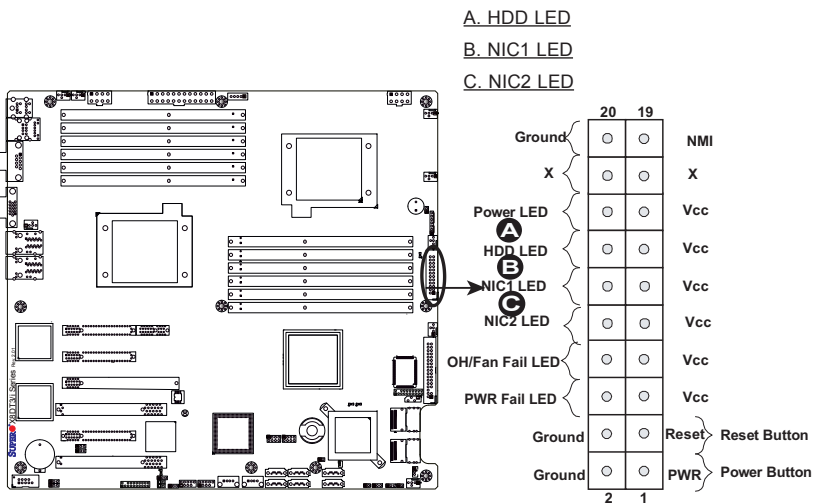

Overheat (OH)/Fan Fail LED

Connect an LED Cable to the OH/ Fan Fail connection on pins 7 and 8 of JF1 to provide advanced warnings of chassis overheating or fan failure. Refer to the table on the right for pin definitions.

OH/Fan Fail LED Pin Definitions (JF1)	
Pin#	Definition
7	Vcc
8	Ground

OH/Fan Fail Indicator Status	
State	Definition
Off	Normal
On	Overheat
Flashing	Fan Fail

Power Fail LED

The Power Fail LED connection is located on pins 5 and 6 of JF1. Refer to the table on the right for pin definitions.

PWR Fail LED Pin Definitions (JF1)	
Pin#	Definition
5	Vcc
6	Ground

A. OH/Fan Fail LED

B. PWR Supply Fail

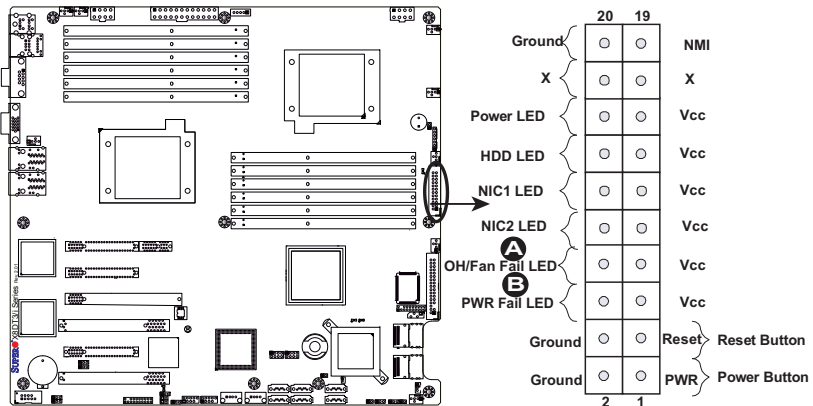

Reset Button

The Reset Button connection is located on pins 3 and 4 of JF1. Attach it to a hardware reset switch on the computer case. Refer to the table on the right for pin definitions.

Reset Button Pin Definitions (JF1)	
Pin#	Definition
3	Reset
4	Ground

Power Button

The Power Button connection is located on pins 1 and 2 of JF1. Momentarily contacting both pins will power on/off the system. This button can also be configured to function as a suspend button (with a setting in the BIOS - see Chapter 4). To turn off the power when set to suspend mode, press the button for at least 4 seconds. Refer to the table on the right for pin definitions.

Power Button Pin Definitions (JF1)	
Pin#	Definition
1	Signal
2	+3V Standby

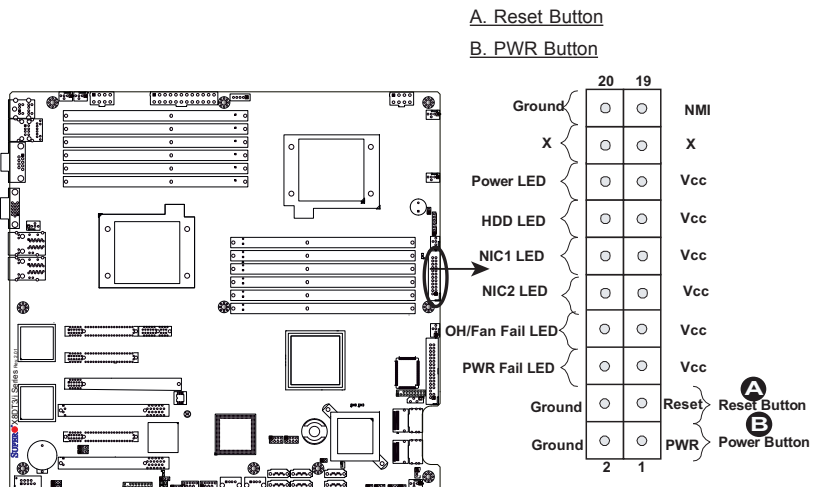

2-6 Connecting Cables

Power Connectors

A 24-pin main power supply connector(JPW3) and two 8-pin CPU PWR connectors (JPW1/JPW2) on the motherboard. These power connectors meet the SSI EPS 12V specification. In addition to the 24-pin ATX power connector, the 12V 8-pin CPU PWR connectors at JPW1/JPW2 must also be connected to your power supply. See the table on the right for pin definitions.



Warning: To prevent damage to the power supply or motherboard, please use a power supply that contains a 24-pin and two 8-pin power connectors. Be sure to connect these connectors to the 24-pin (JPW3) and the two 8-pin (JPW1,JPW2) power connectors on the motherboard. Failure in doing so will void the manufacturer warranty on your power supply and motherboard.

Pin#	Definition	Pin #	Definition
13	+3.3V	1	+3.3V
14	-12V	2	+3.3V
15	COM	3	COM
16	PS_ON	4	+5V
17	COM	5	COM
18	COM	6	+5V
19	COM	7	COM
20	Res (NC)	8	PWR_OK
21	+5V	9	5VSB
22	+5V	10	+12V
23	+5V	11	+12V
24	COM	12	+3.3V

(Required)

Pins	Definition
1 through 4	Ground
5 through 8	+12V

(Required)

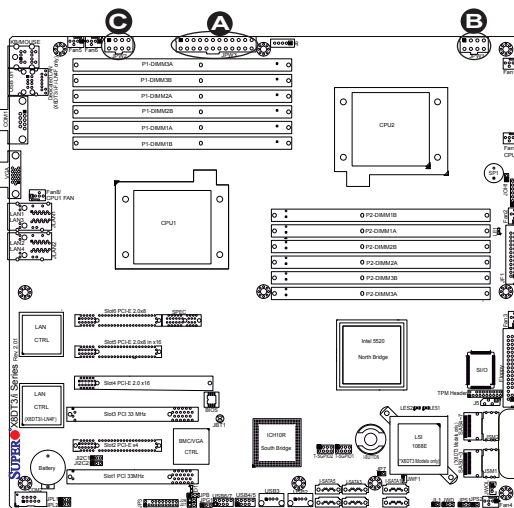

A. 24-pin ATX PWR

(Req'd)

B/C. 8-pin Processor PWR

(Req'd)

Fan Headers

This motherboard has six chassis/system fan headers (Fan1 to Fan6) and two CPU fans (Fan7/Fan8) on the motherboard. All these 4-pin fans headers are backward compatible with the traditional 3-pin fans. However, fan speed control is available for 4-pin fans only. The fan speeds are controlled by Thermal Management via Hardware Monitoring in the Advanced Setting in the BIOS. (The Default setting is Disabled.) See the table on the right for pin definitions.

Fan Header Pin Definitions	
Pin#	Definition
1	Ground
2	+12V
3	Tachometer
4	PWR Modulation

Chassis Intrusion

A Chassis Intrusion header is located at JL1 on the motherboard. Attach an appropriate cable from the chassis to inform you of a chassis intrusion when the chassis is opened.

Chassis Intrusion Pin Definitions (JL1)	
Pin#	Definition
1	Intrusion Input
2	Ground

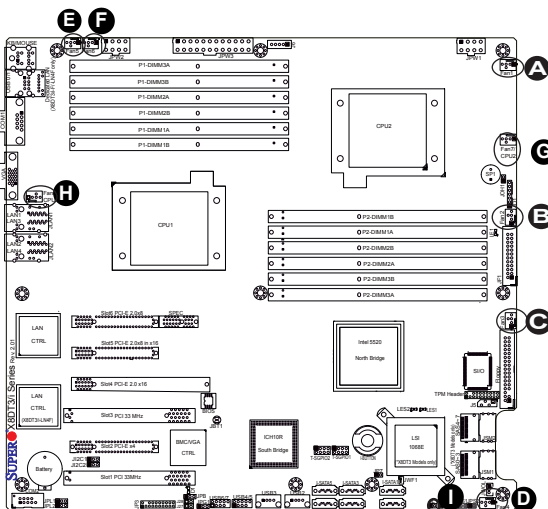

- A. Fan 1
- B. Fan 2
- C. Fan 3
- D. Fan 4
- E. Fan 5
- F. Fan 6
- G. Fan 7 (CPU2 Fan)
- H. Fan 8 (CPU1 Fan)
- I. Chassis Intrusion

Internal Speaker

The Internal Speaker, located at SP1, can be used to provide audible indications for various beep codes. See the table on the right for pin definitions. Refer to the layout below for the locations of the Internal Buzzer (SP1).

Internal Buzzer (SP1) Pin Definition		
Pin#	Definitions	
Pin 1	Pos. (+)	Beep In
Pin 2	Neg. (-)	Alarm Speaker

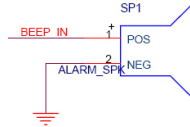

Power LED/Speaker

On the JD1 header, pins 1-3 are used for power LED indication, and pins 4-7 are for the speaker. See the table on the right for speaker pin definitions. Please note that the speaker connector pins (4-7) are for use with an external speaker. If you wish to use the onboard speaker, you should close pins 6-7 with a jumper.

Speaker Connector	
Pin Setting	Definition
Pins 6-7	Internal Speaker
Pins 4-7	External Speaker

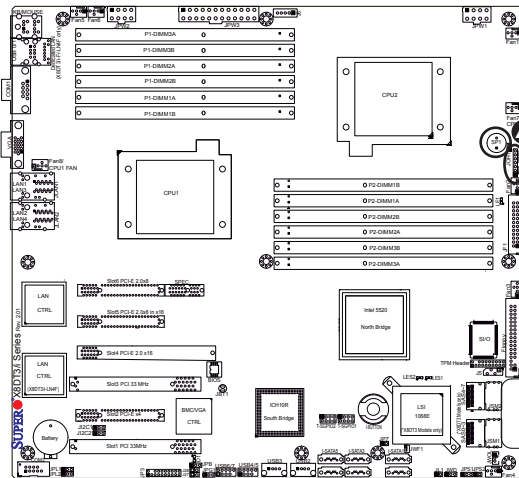

A. Internal Speaker (Buzzer)

B. PWR LED/Speaker

Wake-On-LAN

The Wake-On-LAN header is located at JWOL on the motherboard. You must also have a LAN card with a Wake-On-LAN connector and a cable to use this feature. See the table on the right for pin definitions.

Wake-On-LAN Pin Definitions	
Pin#	Definition
1	+5V Standby
2	Ground
3	Wake-up

Overheat LED/Fan Fail (JOH1)

The JOH1 header is used to connect an LED indicator to provide warnings of chassis overheating or fan failure. This LED will blink when a fan failure occurs. Refer to the table on right for pin definitions.

Overheat LED Pin Definitions	
Pin#	Definition
1	5vDC
2	OH Active

OH/Fan Fail LED Pin Definitions	
State	Message
Solid	Overheat
Blinking	Fan Fail

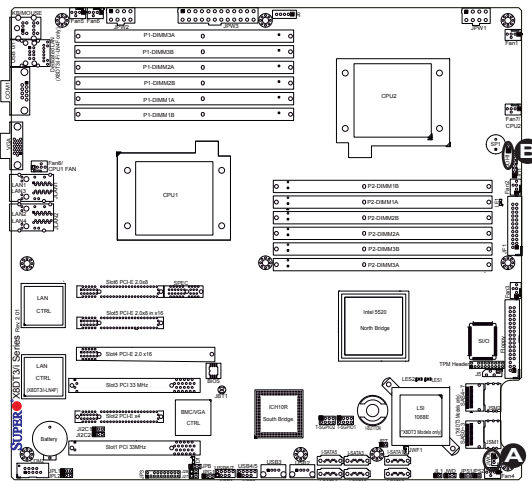

A. Wake-On-LAN

B. Overheat/Fan Fail

LED

T-SGPIO Headers

Two SGPIO (Serial-Link General Purpose Input/Output) headers (T-SGPIO-1/T-SGPIO-2) are located the motherboard. These headers support serial link interfaces for the onboard SATA and SAS connectors. See the table on the right for pin definitions. Refer to the board layout below for the location.

T-SGPIO Pin Definitions			
Pin#	Definition	Pin	Definition
1	NC	2	NC
3	Ground	4	Data
5	Load	6	Ground
7	NC	8	NC

Note: NC= No Connections

**I-Button (Optional for X8DT3-F/
LN4F only)**

An onboard I-Button, located next to USB Ports 2~3, is an 1-wire computer chip enclosed in a durable stainless steel can. I-Button stores instructions, provides electronic interface and allows HostRAID to operate with Mega-RAID firmware.

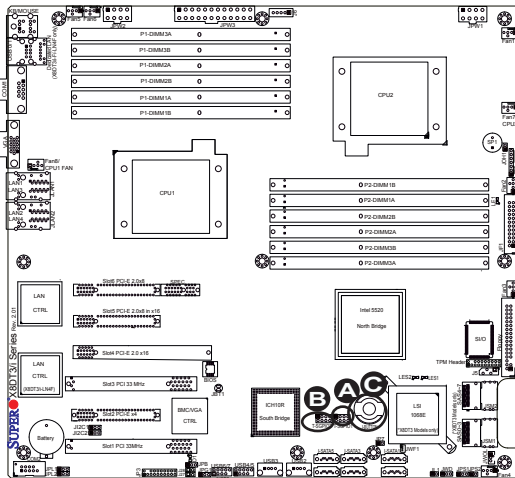

- A. T-SGPIO-1
- B. T-SGPIO-2
- C. I-Button (Optional for X8DT3 models only)

Power SMB (I²C) Connector

Power System Management Bus (I²C) Connector (J6) monitors power supply, fan and system temperatures. See the table on the right for pin definitions.

PWR SMB Pin Definitions	
Pin#	Definition
1	Clock
2	Data
3	PWR Fail
4	Ground
5	+3.3V

IPMB I²C SMB

A System Management Bus header for the IPMI slot is located at J5. Connect the appropriate cable here to use the IPMB I²C connection on your system.

SMB Header Pin Definitions	
Pin#	Definition
1	Data
2	Ground
3	Clock
4	No Connection

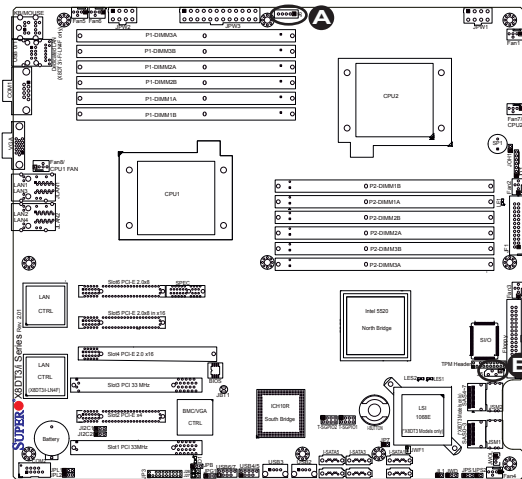

A. PWR SMB

B. IPMB SMB

TPM Header

A Trusted Platform Module header (JTPM1) is located next to COM2 port to provide TPM support for system data security. See the table on the right for pin definitions.

 **Note:** This header is available on a R. 2.00 or later version of motherboard.

TPM Header Pin Definitions			
Pin #	Definition	Pin #	Definition
1	LCLK	2	GND
3	LFRAME#	4	<(KEY)>
5	LRESET#	6	+5V (X)
7	LAD 3	8	LAD 2
9	+3.3V	10	LAD1
11	LAD0	12	GND
13	SMB_CLK4	14	SMB_DAT4
15	+3V_DUAL	16	SERIRQ
17	GND	18	CLKRUN# (X)
19	LPCPD#	20	LDRQ# (X)

DOM Power Connector

A power connector for SATA DOM (Disk_On_Module) Devices is located at JWF1. Connect the appropriate cable here to provide power support for your DOM devices.

 **Note:** This header is available on a R. 2.00 or later version of motherboard.

DOM PWR Pin Definitions	
Pin#	Definition
1	+5V
2	Ground
3	Ground

A. TPM Header
 B. DOM PWR

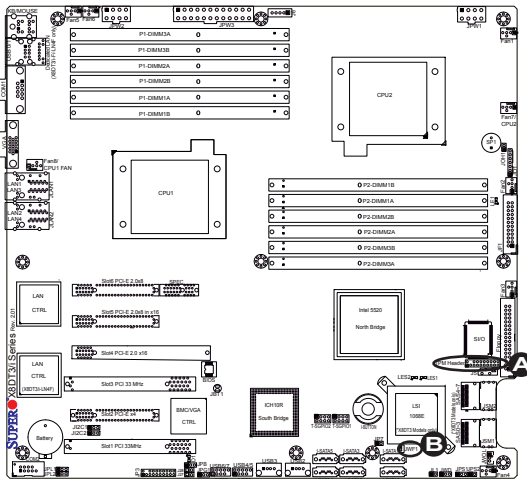

2-7 Jumper Settings

Explanation of Jumpers

To modify the operation of the motherboard, jumpers can be used to choose between optional settings. Jumpers create shorts between two pins to change the function of the connector. Pin 1 is identified with a square solder pad on the printed circuit board. See the motherboard layout pages for jumper locations.

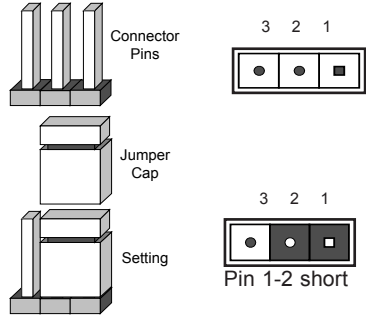

Note: On two pin jumpers, "Closed" means the jumper is on and "Open" means the jumper is off the pins.

GLAN Enable/Disable

Use JPL1 to enable or disable the GLAN Ports 1 & 2. Use JPL2 to enable or disable the GLAN Ports 3 & 4 on the X8DT3/i-LN4F. See the tables on the right for jumper settings. The default setting is **Enabled**.

GLAN 1 & 2 Enable Jumper Settings (JPL1)	
Pin#	Definition
1-2	Enabled (default)
2-3	Disabled

GLAN 3 & 4 Enable Jumper Settings (JPL2)	
Pin#	Definition
1-2	Enabled (default)
2-3	Disabled

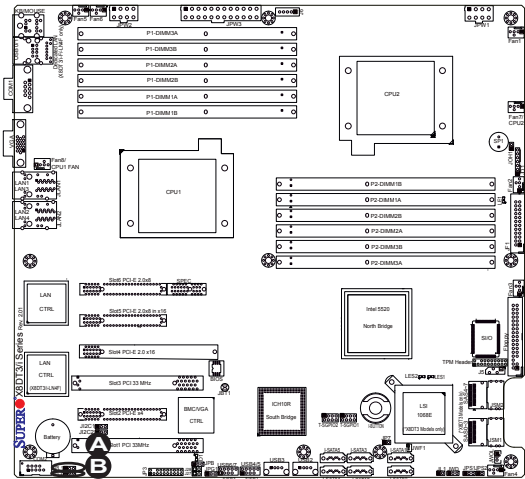

- A. GLAN 1 & 2 Enable
 - B. GLAN 3 & 4 Enable
- (For X8DT3/i-LN4F only)

CMOS Clear

JBT1 is used to clear CMOS. Instead of pins, this "jumper" consists of contact pads to prevent the accidental clearing of CMOS. To clear CMOS, use a metal object such as a small screwdriver to touch both pads at the same time to short the connection. Always remove the AC power cord from the system before clearing CMOS.



Note: For an ATX power supply, you must completely shut down the system, remove the AC power cord and then short JBT1 to clear CMOS.



Watch Dog Enable/Disable

Watch Dog (JWD) is a system monitor that can reboot the system when a software application hangs. Close Pins 1-2 to reset the system if an application hangs. Close Pins 2-3 to generate a non-maskable interrupt signal for the application that hangs. See the table on the right for jumper settings. Watch Dog must also be enabled in the BIOS.

Watch Dog Jumper Settings (JWD)	
Jumper Setting	Definition
Pins 1-2	Reset (default)
Pins 2-3	NMI
Open	Disabled

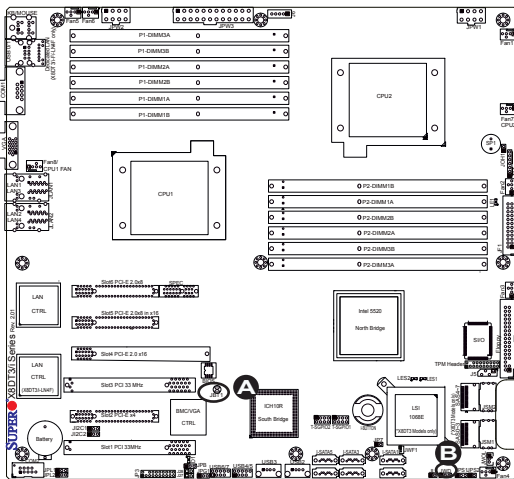

A. Clear CMOS

B. Watch Dog Enable

I²C Bus to PCI-Exp. Slots

Jumpers JI²C1 and JI²C2 allow you to connect the System Management Bus (I²C) to PCI-Express slots. The default setting is Open to disable the connection. See the table on the right for jumper settings.

I ² C to PCI-Exp Jumper Settings	
Jumper Setting	Definition
1-2	Enabled
2-3	Disabled (Default)

VGA Enable

Jumper JPG1 allows the user to enable the onboard VGA connector. The default setting is 1-2 to enable the connection. See the table on the right for jumper settings.

VGA Enable Jumper Settings	
Jumper Setting	Definition
1-2	Enabled (Default)
2-3	Disabled

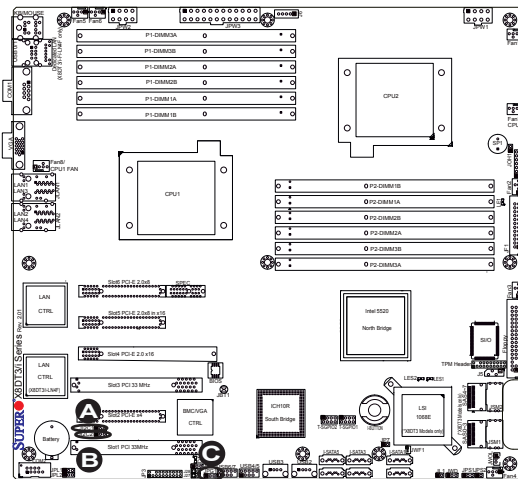

- A. JI²C1
- B. JI²C2
- C. VGA Enable

**SAS Enable/Disable (X8DT3/
X8DT3-F/X8DT3-LN4F only)**

Jumper JPS1 allows you to enable or disable the onboard SAS connections. The default setting is Pins 1-2 to enable the connection. See the table on the right for jumper settings.

SAS Enable Jumper Settings	
Jumper Setting	Definition
1-2	SAS Enabled (Default)
2-3	SAS Disabled

**SAS RAID Select (X8DT3/X8DT3-F/
X8DT3-LN4F only)**

Jumper JPS2 allows you to select RAID Configuration settings for the onboard SAS connections. See the table on the right for jumper settings.

SAS RAID Config. Select Jumper Settings	
Jumper Setting	Definition
Open	Integrated Target Mode (IT)
Closed	Software RAID (SR) (Default)



Note: For more information on LSI SAS RAID configuration, please refer to the LSI MegaRAID User's Guide posted on our website @ <http://www.supermicro.com/support/manuals/>.

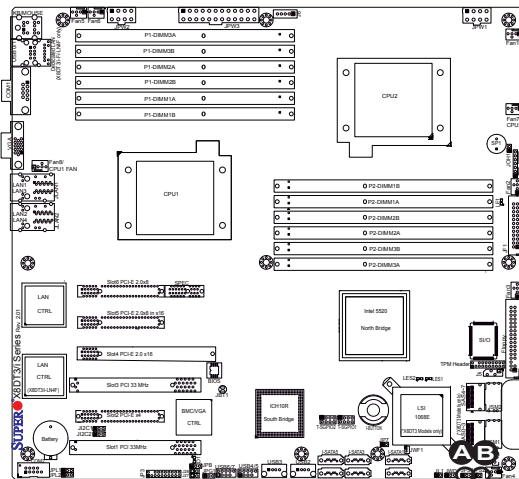

- A. SAS Enable
- B. SAS RAID Config. Select

2-8 Onboard LED Indicators

GLAN LEDs

Two LAN ports (LAN 1/LAN 2) are located on the IO Backplane of the motherboard. In addition, LAN3/LAN4 are located on the X8DT3/i-LN4F. Each Ethernet LAN port has two LEDs. The yellow LED indicates activity, while the Link LED may be green, amber or off to indicate the speed of the connections. See the tables at right for more information.

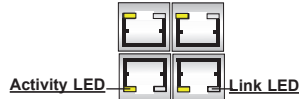

Rear View (when facing the rear side of the chassis)

LAN 1/LAN 2 Activity LED (Left) LED State		
Color	Status	Definition
Yellow	Flashing	Active

LAN 1/LAN 2 Link LED (Right) LED State	
LED Color	Definition
Off	No Connection or 10 Mbps
Green	100 Mbps
Amber	1 Gbps

IPMI Dedicated LAN LEDs (X8DT3/i-F/-LN4F Only)

In addition to LAN 1/LAN 2, an IPMI Dedicated LAN is also located on the IO Backplane of the X8DT3/i-F/-LN4F. The amber LED on the right indicates activity, while the green LED on the left indicates the speed of the connection. See the tables at right for more information.

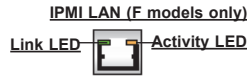

IPMI LAN Link LED (Left) & Activity LED (Right)		
Color	Status	Definition
Link (Left)	Green: Solid	100 Mbps
Activity (Right)	Amber: Blinking	Active

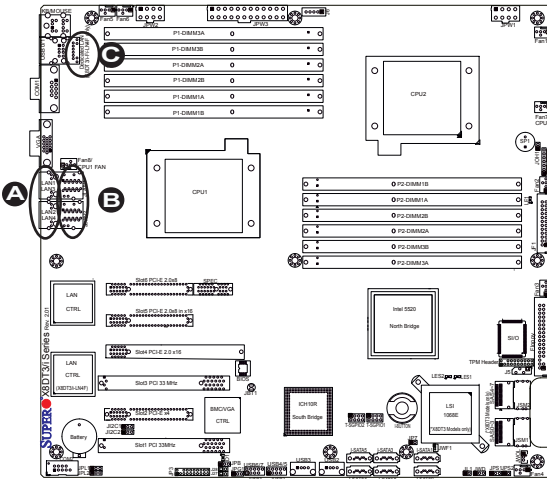

- A. LAN1/2 LEDs
- B. LAN3/4 LEDs (X8DT3/i-LN4)
- B. Dedicated LAN LEDs (X8DT3/i-F/-LN4F)

SAS Heartbeat/Activity LED Indicators

Two Onboard SAS LED are located on the motherboard. LES1 is SAS Heartbeat LED, and LES2 is SAS Activity LED. When LES1 is blinking, SAS connections function normally. When this LES2 is blinking, SAS connections are active. See the tables at right for more information.

Onboard SAS LED Indicators (LES1/LES2) Settings	
LED Color	Definition
LES1	Blinking: SAS: Normal
LES2	Blinking: SAS: Active

BMC Heartbeat LED

A BMC Heartbeat LED is located at D1 on the motherboard. When D1 is blinking, BMC functions normally. See the tables at right for more information.

BMC Heartbeat LED Indicators (D1) Settings	
LED#	Definition
D1	Blinking: BMC: Normal

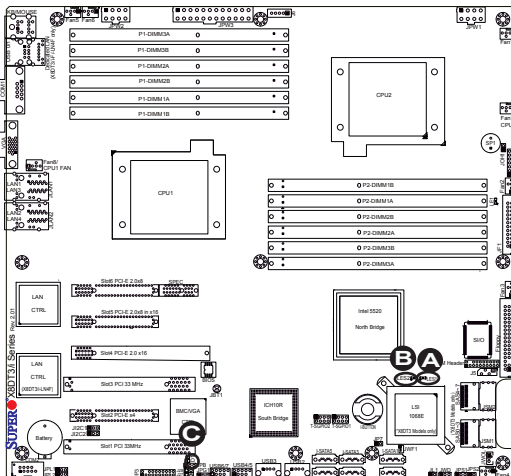

A. SAS Heartbeat LED

B. SAS Activity LED

C. BMC Heartbeat LED

Onboard Power LED

An Onboard Power LED is located at LE1 on the motherboard. When this LED is lit, the system is on. Be sure to turn off the system and unplug the power cord before removing or installing components. See the tables at right for more information.

Onboard PWR LED (LE1) Settings	
LED Color	Definition
Off	System Off (PWR cable not connected)
Green	System Power On

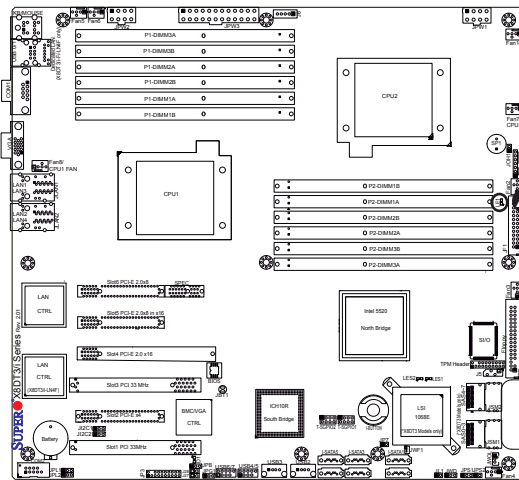

A. Onboard Power LED

2-9 Floppy Drive, Serial ATA and SAS Connections

Note the following when connecting the floppy and hard disk drive cables:

- The floppy disk drive cable has seven twisted wires.
- A red mark on a wire typically designates the location of pin 1.
- A single floppy disk drive ribbon cable has 34 wires and two connectors to provide for two floppy disk drives. The connector with twisted wires always connects to drive A, and the connector that does not have twisted wires always connects to drive B.

Floppy Connector

The floppy connector is located next to the Super I/O chip on the motherboard. See the table on the right for pin definitions.

Floppy Drive Connector Pin Definitions			
Pin#	Definition	Pin #	Definition
1	Ground	2	FDHDIN
3	Ground	4	Reserved
5	Key	6	FDEDIN
7	Ground	8	Index
9	Ground	10	Motor Enable
11	Ground	12	Drive Select B
13	Ground	14	Drive Select B
15	Ground	16	Motor Enable
17	Ground	18	DIR
19	Ground	20	STEP
21	Ground	22	Write Data
23	Ground	24	Write Gate
25	Ground	26	Track 00
27	Ground	28	Write Protect
29	Ground	30	Read Data
31	Ground	32	Side 1 Select
33	Ground	34	Diskette

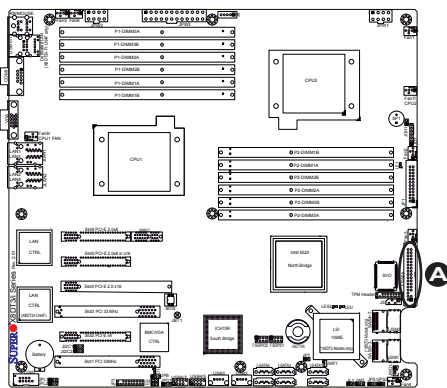

A. Floppy

Serial ATA Ports

Six Serial ATA Ports (I-SATA0~I-SATA 5) are located at JS1~JS6 on the motherboard. These ports provide serial-link signal connections, which are faster than the connections of Parallel ATA. See the table on the right for pin definitions.

Serial ATA Pin Definitions	
Pin#	Definition
1	Ground
2	TX_P
3	TX_N
4	Ground
5	RX_N
6	RX_P
7	Ground

SAS Ports (X8DT3/X8DT3-F/ X8DT3-LN4F only)

SAS Ports 0~3, 4~7, located at JSM1/ JSM2, provide Serial-Attached SCSI connections on the X8DT3/X8DT3-F/ X8DT3-LN4F. See the layout below for SAS port locations.



Note 1: For more information on SATA HostRAID configuration, please refer to the Intel SATA HostRAID User's Guide posted on our website @ <http://www.supermicro.com/support/manuals/>.

Note 2: For more information on LSI SAS RAID configuration, please refer to the LSI MegaRAID User's Guide posted on our website @ <http://www.supermicro.com/support/manuals/>.

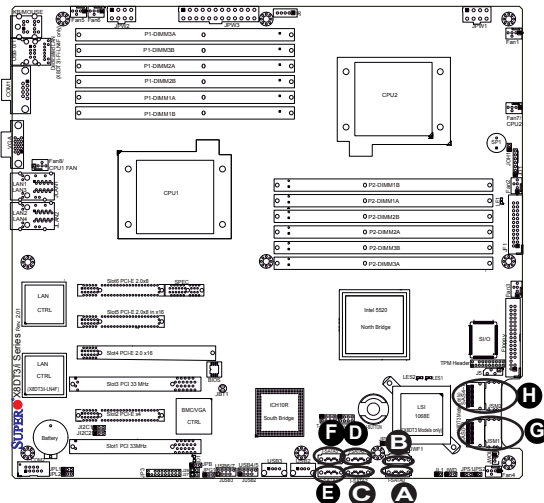

- A. I-SATA0
- B. I-SATA1
- C. I-SATA2
- D. I-SATA3
- E. I-SATA4
- F. I-SATA5
- G. SAS 0~3 (X8DT3-F/LN4F only)
- H. SAS 4~7 (X8DT3-F/LN4F only)

Chapter 3

Troubleshooting

3-1 Troubleshooting Procedures

Use the following procedures to troubleshoot your system. If you have followed all of the procedures below and still need assistance, refer to the 'Technical Support Procedures' and/or 'Returning Merchandise for Service' section(s) in this chapter. Note: Always disconnect the power cord before adding, changing or installing any hardware components.

Before Power On

1. Make sure that there are no short circuits between the motherboard and chassis.
2. Disconnect all ribbon/wire cables from the motherboard, including those for the keyboard and mouse. Be sure to remove all add-on cards as well.
3. Install CPU 1 first (making sure it is fully seated) and connect the chassis speaker and the power LED to the motherboard. (Check all jumper settings.)

No Power

1. Make sure that there are no short circuits between the motherboard and the chassis.
2. Make sure that all jumpers are set to the default positions.
3. Check that the 115V/230V switch on the power supply is properly set.
4. Turn the power switch on and off to test the system.
5. The battery on your motherboard may be old. Check to verify that it still supplies ~3VDC. If it does not, replace it with a new one.

No Video

1. If the power is on but you have no video, remove all the add-on cards and cables.

2. Use the speaker to determine if any beep codes exist. Refer to Appendix A for details on beep codes.

Losing the System's Setup Configuration

1. Make sure that you are using a high quality power supply. A poor quality power supply may cause the system to lose the CMOS setup information. Refer to Section 1-6 for details on recommended power supplies.
2. The battery on your motherboard may be old. Check to verify that it still supplies ~3VDC. If it does not, replace it with a new one.
3. If the above steps do not fix the Setup Configuration problem, contact your vendor for repairs.

Memory Errors

When a No_Memory_Beep_Code is issued by the system, check the following:

1. Make sure that the DIMM modules are properly and fully installed.
2. Check if different speeds of DIMMs have been installed. It is strongly recommended to use the same RAM speed for all DIMMs in the system.
3. Make sure that you are using the correct type of Registered ECC or Unbuffered ECC/Non-ECC DDR3 1333 MHz/1066 MHz/800 MHz SDRAM (recommended by the manufacturer.)
4. Check for bad DIMM modules or slots by swapping a single module between all memory slots and check the results.
5. Make sure that all memory modules are fully seated in their slots. Make sure to follow the instructions given in Section 2-4 in Chapter 2.
6. Check the position of the 115V/230V switch on the power supply.
7. Please follow the instructions given in the DIMM Population Tables listed on Section 2-4 (Chapter 2) to install your memory modules.

3-2 Technical Support Procedures

Before contacting Technical Support, please take the following steps. Also, please note that as a motherboard manufacturer, Supermicro does not sell directly to end-

users, so it is best to first check with your distributor or reseller for troubleshooting services. They should know of any possible problem(s) with the specific system configuration that was sold to you.

1. Please go through the 'Troubleshooting Procedures' and 'Frequently Asked Question' (FAQ) sections in this chapter or see the FAQs on our web site (<http://www.supermicro.com/support/faqs/>) before contacting Technical Support.
2. BIOS upgrades can be downloaded from our web site at (<http://www.supermicro.com/support/bios/>).
3. If you still cannot resolve the problem, include the following information when contacting Supermicro for technical support:
 - Motherboard model and PCB revision number
 - BIOS release date/version (this can be seen on the initial display when your system first boots up)
 - System configuration
 - A Technical Support form can be downloaded at (<http://www.supermicro.com/support/contact.cfm>).
 - Distributors: For immediate assistance, please have your account number ready when placing a call to our technical support department. We can be reached by e-mail at support@supermicro.com or by fax at: (408) 503-8000, option 2.

3-3 Frequently Asked Questions

Question: What are the types of memory can be supported by my board?

Answer: This motherboard has 12 240-pin DIMM slots that support DDR3 Registered ECC or Unbuffered ECC/Non-ECC 1333MHz/1066 MHz/800 MHz SDRAM modules. Please follow all memory installation instructions in Chapter 2.

Question: How do I update my BIOS?

Answer: It is recommended that you **do not** upgrade your BIOS if you are not experiencing any problems with your system. Updated BIOS files are located on our web site at <http://www.supermicro.com/support/bios/>. Please check our BIOS warning message and the information on how to update your BIOS on our web site. Select your motherboard model and download the BIOS file to your computer. Also, check the current BIOS revision and make sure that it is newer than your

BIOS before downloading. You can choose from the zip file and the .exe file. If you choose the zip BIOS file, please unzip the BIOS file onto a bootable USB device. Run the batch file using the format flash.bat filename.rom from your bootable USB device to flash the BIOS. Then, your system will automatically reboot. Please note that this process may take a few minutes to complete. Do not be concerned if the screen is paused for a few minutes.



Warning: Do not shut down or reset the system while updating the BIOS to prevent possible system boot failure!



Notes: **1.** The SPI BIOS chip used on this motherboard cannot be removed. Send your motherboard back to our RMA Department at Supermicro for repair. **2.** For AMI BIOS Recovery, please refer to the AMI BIOS Recovery Instructions posted on our website at <http://www.supermicro.com/support/manuals/>.

Question: What's on the CD that came with my motherboard?

Answer: The supplied CD has drivers and programs that are needed for your system. Please review the CD and install the applications you need. Applications on the CD include chipset drivers for the Windows OS, security and audio drivers.

Question: How do I handle the used battery?

Answer: Please handle used batteries carefully. Do not damage the battery in any way; a damaged battery may release hazardous materials into the environment. Do not discard a used battery in the garbage or a public landfill. Please comply with the regulations set up by your local hazardous waste management agency to dispose of your used battery properly.

3-4 Returning Merchandise for Service

A receipt or copy of your invoice marked with the date of purchase is required before any warranty service will be rendered. You can obtain service by calling your vendor for a Returned Merchandise Authorization (RMA) number. When returning to the manufacturer, the RMA number should be prominently displayed on the outside of the shipping carton, and mailed prepaid or hand-carried. Shipping and handling charges will be applied for all orders that must be mailed when service is complete. For faster service, You can also request a RMA authorization online (<http://www.supermicro.com/support/rma/>).

This warranty only covers normal consumer use and does not cover damages incurred in shipping or from failure due to the alternation, misuse, abuse or improper maintenance of products.

During the warranty period, contact your distributor first for any product problems.

Chapter 4

BIOS

4-1 Introduction

This chapter describes the AMI BIOS Setup Utility for the X8DT3/X8DTi/X8DT3-LN4/X8DTi-LN4. The AMI ROM BIOS is stored in a Flash EEPROM and can be easily updated. This chapter describes the basic navigation of the AMI BIOS Setup Utility setup screens.

Starting BIOS Setup Utility

To enter the AMI BIOS Setup Utility screens, press the <Delete> key while the system is booting up.



Note: In most cases, the <Delete> key is used to invoke the AMI BIOS setup screen. There are a few cases when other keys are used, such as <F1>, <F2>, etc.

Each main BIOS menu option is described in this manual. The Main BIOS setup menu screen has two main frames. The left frame displays all the options that can be configured. Grayed-out options cannot be configured. Options in blue can be configured by the user. The right frame displays the key legend. Above the key legend is an area reserved for a text message. When an option is selected in the left frame, it is highlighted in white. Often a text message will accompany it. (**Note:** the AMI BIOS has default text messages built in. Supermicro retains the option to include, omit, or change any of these text messages.)

The AMI BIOS Setup Utility uses a key-based navigation system called "hot keys". Most of the AMI BIOS setup utility "hot keys" can be used at any time during the setup navigation process. These keys include <F1>, <F10>, <Enter>, <ESC>, arrow keys, etc.



Note 1: Options printed in **Bold** are default settings.

Note 2: For AMI BIOS Recovery, please refer to the AMI BIOS Recovery Instructions posted on our website at <http://www.supermicro.com/support/manuals/>.

How To Change the Configuration Data

The configuration data that determines the system parameters may be changed by entering the AMI BIOS Setup utility. This Setup utility can be accessed by pressing at the appropriate time during system boot.

Starting the Setup Utility

Normally, the only visible Power-On Self-Test (POST) routine is the memory test. As the memory is being tested, press the <Delete> key to enter the main menu of the AMI BIOS Setup Utility. From the main menu, you can access the other setup screens. An AMI BIOS identification string is displayed at the left bottom corner of the screen below the copyright message.



Warning! Do not upgrade the BIOS unless your system has a BIOS-related issue. Flashing the wrong BIOS can cause irreparable damage to the system. In no event shall Supermicro be liable for direct, indirect, special, incidental, or consequential damages arising from a BIOS update. If you have to update the BIOS, do not shut down or reset the system while the BIOS is updating. This is to avoid possible boot failure.

4-2 Main Setup

When you first enter the AMI BIOS Setup Utility, you will enter the Main setup screen. You can always return to the Main setup screen by selecting the Main tab on the top of the screen. The Main BIOS Setup screen is shown below.

BIOS SETUP UTILITY	
Main	Advanced Security Boot Exit
System Overview	
System Time	[05:22:46]
System Date	[Tue 01/01/2002]
Supermicro X8DT3/X8DTi	
BIOS Build Ver :2.0c	
BIOS Build Date :08/30/11	
Processor	
Intel(R) Xeon(R) CPU X5675 @ 3.07GHz	
Speed	:3066MHz
Physical Count	:1
Logical Count	:12
System Memory	
Size	:2040MB
Use [ENTER], [TAB] or [SHIFT-TAB] to select a field. Use [+] or [-] to configure system Date. + Select Screen ↑ Select Item +- Change Field Tab Select Field F1 General Help F10 Save and Exit ESC Exit	
v02.69 (C) Copyright 1985-2010, American Megatrends, Inc.	

System Overview: The following BIOS information will be displayed:

System Time/System Date

Use this option to change the system time and date. Highlight *System Time* or *System Date* using the arrow keys. Enter new values through the keyboard and press <Enter>. Press the <Tab> key to move between fields. The date must be entered in Day MM/DD/YY format. The time is entered in HH:MM:SS format. (**Note:** The time is in the 24-hour format. For example, 5:30 P.M. appears as 17:30:00.)

Supermicro X8DT3/ X8DTi

- BIOS Build Version: This item displays the BIOS revision used in your system.
- BIOS Build Date: This item displays the date when this BIOS was completed.

AMI BIOS Core Version: This item displays the revision number of the AMI BIOS Core upon which your BIOS was built.

Processor

The AMI BIOS will automatically display the status of the processor used in your system:

- CPU Type: This item displays the type of CPU used in the motherboard.
- Speed: This item displays the speed of the CPU detected by the BIOS.
- Physical Count: This item displays the number of processors installed in your system as detected by the BIOS.
- Logical Count: This item displays the number of CPU Cores installed in your system as detected by the BIOS.

System Memory

This displays the size of memory available in the system:

- Size: This item displays the memory size detected by the BIOS.

4-3 Advanced Setup Configurations

Use the arrow keys to select Boot Setup and press <Enter> to access the submenu items:

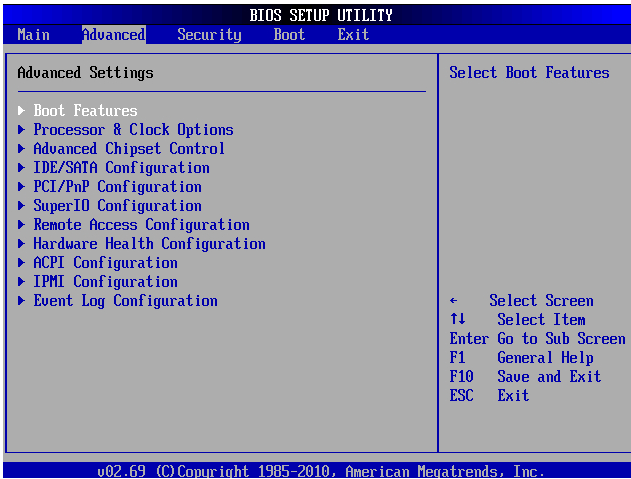

▶ Boot Features

Quick Boot

If Enabled, this option will skip certain tests during POST to reduce the time needed for system boot. The options are **Enabled** and Disabled.

Quiet Boot

This option is used to select the bootup screen between POST messages or the OEM logo. Select Disabled to display the POST messages. Select Enabled to display the OEM logo instead of the normal POST messages. The options are **Enabled** and Disabled.

AddOn ROM Display Mode

This sets the display mode for the Option ROM. Select Keep Current to use the current AddOn ROM Display setting. Select Force BIOS to use the Option ROM display mode set by the system BIOS. The options are **Force BIOS** and Keep Current.

Boots Graphics Adapter Priority

Use this feature to specify which graphics controller to be used as the primary boot device. The options are **Onboard VGA**, Slot#1, Slot#2, Slot#3, Slot#4, Slot#5, Slot#6,

Bootup Num-Lock

This feature is used to select the Power-on state for Numlock key. The options are Off and **On**.

Wait For 'F1' If Error

Select Enabled force the system to wait until the 'F1' key is pressed when an error occurs. The options are Disabled and **Enabled**.

Hit 'Del' Message Display

Select Enabled to display "Press DEL to run Setup" during POST. The options are **Enabled** and Disabled.

Interrupt 19 Capture

Interrupt 19 is the software interrupt that handles the boot disk function. When this item is set to Enabled, the ROM BIOS of the host adaptors will "capture" Interrupt 19 at bootup and allow the drives that are attached to these host adaptors to function as bootable disks. If this item is set to Disabled, the ROM BIOS of the host adaptors will not capture Interrupt 19, and the drives attached to these adaptors will not function as bootable devices. The options are **Enabled** and Disabled.

Power Configuration**Power Button Function**

If this feature is set to Instant Off, the system will power off immediately as soon as the user presses the power button. Select 4 Second Override for the system to power off when the user presses the power button for 4 seconds or longer. The options are **Instant Off** and 4 Second Override.

Restore on AC Power Loss

Use this feature to set the power state after a power outage. Select Power-Off for the system power to remain off after a power loss. Select Power-On for the system power to be turned on after a power loss. Select Last State to allow the system to resume its last state before a power loss. The options are Power-On, Power-Off and **Last State**.

Watch Dog Timer

If enabled, the Watch Dog Timer will reboot the system when it is inactive for more than 5 minutes. The options are Enabled and **Disabled**.

► Processor and Clock Options

This submenu allows the user to configure the Processor and Clock settings.

Ratio CMOS Setting

This option allows the user to set the ratio between the CPU Core Clock and the FSB Frequency. (**Note:** if an invalid ratio is entered, the AMI BIOS will restore the setting to the previous state. The Ratio CMOS settings differ, depending on the type of the CPU installed in the system.) The default setting is the maximum ratio allowed for the type of CPU installed in the system.

C1E Support

Select Enabled to enable Enhanced Halt State support. C1E significantly reduces the CPU's power consumption by reducing the CPU's clock cycle and voltage during a "Halt State." The options are Disabled and **Enabled**.

Hardware Prefetcher (Available when supported by the CPU)

If set to Enabled, the hardware prefetcher will prefetch streams of data and instructions from the main memory to the L2 cache to improve CPU performance. The options are Disabled and **Enabled**.

Adjacent Cache Line Prefetch (Available when supported by the CPU)

The CPU prefetches the cache line for 64 bytes if this option is set to Disabled. The CPU prefetches both cache lines for 128 bytes as comprised if **Enabled**.

DCU Prefetcher

Select Enabled to activate Level 1 Data Prefetcher to enhance system performance. For better performance of your DP server, please refer to the specifications of your applications installed in your server to enable or disable this feature. The options are **Enabled** and Disabled.

Data Reuse Optimization (Available when supported by the CPU)

For UP platforms, select Enabled to maximize data reuse support to enhance system performance. For DP/MP servers, enable or disable this feature for system enhancement based on application specifications. The options are **Enabled** and Disabled.

MPS and ACPI MADT Ordering

This feature is used to configure the MPS (Multi-Processor Specifications) and ACPI settings for the motherboard. Select Modern Ordering if XP or a newer version of Windows OS is used in the motherboard. Select Legacy Ordering if 2000 or an earlier version is used. The options are **Modern Ordering** and Legacy Ordering.

Max CPUID Value Limit

This feature is used to set the maximum CPU ID value. Enable this function to boot the legacy operating systems that cannot support processors with extended CPUID functions. The options are Enabled and **Disabled** (for the Windows OS.).

Intel® Virtualization Technology (Available when supported by the CPU)

Select Enabled to use Intel Virtualization Technology, which will allow one platform to run multiple operating systems and applications in independent partitions, creating multiple "virtual" systems in one physical computer. The options are **Enabled** and Disabled. **Note:** If there is any change to this setting, you will need to power off and restart the system for the change to take effect. Please refer to Intel's web site for detailed information.

Execute-Disable Bit Capability (Available when supported by the OS and the CPU)

Select Enabled to enable the Execute Disable Bit support which will allow the processor to designate areas in the system memory where an application code can execute and where it cannot, thus preventing a worm or a virus from flooding illegal codes to overwhelm the processor or damage the system during an attack. The default is **Enabled**. (Refer to Intel and Microsoft websites for more information.)

Intel AES-NI (Available when supported by the OS and the CPU)

If set to Enabled, Intel AES-NI will add new encryption features to help accelerate AES SW application, providing code authorization and signature verification to enhance system security. The default is **Disabled**. (Refer to Intel and Microsoft websites for more information.)

Simultaneous Multi-Threading (Available when supported by the CPU)

Set to Enabled to use the Simultaneous Multi-Threading Technology, which will result in increased CPU performance. The options are Disabled and **Enabled**.

Active Processor Cores

Set to Enabled to use a processor's Second Core and beyond. (Please refer to Intel's website for more information.) The options are **All**, 1, 2, 3, 4, and 5.

Intel® EIST™ Technology

EIST (Enhanced Intel SpeedStep Technology) allows the system to automatically adjust processor voltage and core frequency in an effort to reduce power consumption and heat dissipation. **Please refer to Intel's web site for detailed information.** The options are Disable (Disable GV3) and **Enable (Enable GV3)**.

Intel® Turbo Boost

Select Enabled to use the Turbo Mode to boost system performance. The options are **Enabled** and Disabled.

Performance/Watt Select

Select Power Optimized to use the Turbo Boost mode after the system has been in the P0 state for more than 2 seconds. Select Traditional to use the Turbo Boost mode when the system has been in the P0 state less than 2 seconds. The options are Power Optimized and **Traditional**.

Intel® C-STATE Tech

If enabled, C-State is set by the system automatically to either C2, C3 or C4 state. The options are Disabled and **Enabled**.

C State package Limit Setting (Available when C-State support is enabled)

If this option is set to Auto, the AMI BIOS will automatically set the limit on the C-State package register. The options are **Auto**, C1, C3, C6 and C7.

C1 Auto Demotion

When this item is set to enabled, the CPU will conditionally demote C3, C6 or C7 requests to C1 based on un-core auto-demote information. The options are Disabled and **Enabled**.

C3 Auto Demotion

When this item is set to enabled, the CPU will conditionally demote C6 or C7 requests to C3 based on un-core auto-demote information. The options are Disabled and **Enabled**.

Clock Spread Spectrum

Select Enable to enable Clock Spectrum support, which will allow the BIOS to monitor and attempt to reduce the level of Electromagnetic Interference caused by the components whenever needed. The options are **Disabled** and Enabled.

► Advanced Chipset Control

The items included in the Advanced Settings submenu are listed below:

► CPU Bridge Configuration

QPI Links Speed

Use this feature to select QPI's data transfer speed. The options are Slow-mode, and **Full Speed**.

QPI Frequency

Use this feature to select the desired QPI frequency. The options are **Auto**, 4.800 GT, 5.866GT, 6.400 GT.

QPI L0s and L1

Select Enabled to lower QPI power state. L0s and L1 are automatically selected by the motherboard. The options are **Disabled** and Enabled.

Memory Frequency

This feature forces a DDR3 frequency slower than what the system has detected to run at a certain speed. The available options are **Auto**, Force DDR-800, Force DDR-1066, and Force DDR-1333.

Memory Mode

Select Independent to make all DIMMs available to the operating system. Select Channel Mirroring to maintain two identical copies of all data in Channel 1 and Channel 2 memory modules for data security. Select Lockstep for the motherboard to use two areas of memory to run the same set of operations in parallel. Select Sparing for a preset threshold of correctable errors to be used to trigger fail-over. The spare memory is put online and used as active memory in place of the failed memory. This option is supported by Intel 5600 Series processors only. The options are **Independent**, Channel Mirroring, Lockstep, and Sparing.

Demand Scrubbing

This is a memory error-correction scheme that allows the processor to write corrected data back into the memory block from where it was read by the processor. The options are Enabled and **Disabled**.

Patrol Scrubbing

This is a memory error-correction scheme that works in the background looking for and correcting resident errors. The options are **Enabled** and Disabled.

Throttling - Closed Loop

Throttling improves reliability and reduces power in the processor by automatic voltage control during processor idle states. The options are **Enabled** and Disabled.

► North Bridge Configuration

This feature is used to configure the settings for the Intel North Bridge chip.

Intel I/OAT

The Intel I/OAT (I/O Acceleration Technology) significantly reduces CPU overhead by leveraging CPU architectural usage, freeing the system resource for other tasks. The options are Disabled and **Enabled**.

DCA Technology

Select Enabled to use Intel's DCA (Direct Cache Access) Technology to improve data transfer efficiency. The options are Enabled and **Disabled**.

DCA Prefetch Delay

A DCA Prefetch is used with TOE components to prefetch data in order to shorten execution cycles and maximize data processing efficiency. A TOE device is a specialized, dedicated processor that is installed on an add-on card or a network card to handle some or all packet processing of this add-on card. Prefetching too frequently can saturate the cache directory and delay necessary cache accesses. This feature reduces or increases the frequency the system prefetches data. The options are [8], [16], [24], **[32]**, [40], [48], [56], [64], [72], [80], [88], [96], [104], [112], and [120].

IOH PCI-E Max Payload Size

Some add-on cards perform faster with the coalesce feature, which limits the payload size to 128B; while others, with a payload size of 256B which inhibits the coalesce feature. Please refer to your add-on card user guide for the desired setting. The options are **256B** and 128B.

Intel VT-d

Select Enabled to enable Intel's Virtualization Technology support for Direct I/O VT-d by reporting the I/O device assignments to VMM through the DMAR ACPI Tables. This feature offers fully-protected I/O resource-sharing across the Intel platforms, providing the user with greater reliability, security and availability in networking and data-sharing. The settings are Enabled and **Disabled**.

Active State Power-Management

Select Enabled to use the power management for signal transactions between the PCI Express L0 and L1 Links. Select Enabled to configure PCI-Exp. L0 and L1 Link power states. The options are **Disabled** and Enabled.

► South Bridge Configuration

This feature allows the user to configure the settings for the Intel ICH South Bridge settings.

USB Functions

Select Enabled to use onboard USB connections. The Options are Disabled and **Enabled**.

Legacy USB Support

Select Enabled to use Legacy USB devices. If this item is set to Auto, Legacy USB support will be automatically enabled if a legacy USB device is installed on the motherboard. The settings are Disabled, **Enabled** and Auto.

Port 64/60 Emulation

Select Enabled to enable 64h/60h emulation for complete USB keyboard support for operating systems that are not compatible with USB devices. The options are Enabled and **Disabled**.

USB 2.0 Controller (Available when the item: USB Functions is disabled)

This feature displays the current USB controller used in the motherboard. The settings are Disabled, and **Enabled**.

USB 2.0 Controller Mode

This setting allows you to select the USB 2.0 Controller mode. The options are **Hi-Speed (480 Mbps)** and Full Speed (12 Mbps).

BIOS EHCI Hand-Off

Select Enabled to enable BIOS Enhanced Host Controller Interface support to provide a workaround solution for an operating system that does not have EHCI Hand-Off support. When enabled, the EHCI Interface will be changed from the BIOS-controlled to the OS-controlled. The options are Disabled and **Enabled**.

Reserved Page Route

Select PCI to use the PCI communication mode for the USB connections. Select LPC to use the LPC mode for the USB connections. The options are **PCI** and LPC.

► IDE/SATA Configuration

When this submenu is selected, the AMI BIOS automatically detects the presence of the IDE devices and displays the following items:

SATA#1 Configuration

Select Compatible to set SATA#1 to legacy compatibility mode. Select Enhanced to set SATA#1 to native SATA mode. The options are Disabled, Compatible and **Enhanced**.

Configure SATA#1 as

This feature is used to select the drive type for SATA#1. Select RAID (Intel) to enable Intel's SATA RAID firmware and configure SATA#1 as an Intel's SATA RAID device. Select RAID (Adaptec) to enable Adaptec's SATA RAID firmware and configure SATA#1 as an Adaptec's SATA RAID device. The options are **IDE**, RAID (Intel), RAID (Adaptec), and AHCI.

SATA#2 Configuration

Select Enhanced to set SATA#2 to the native SATA mode. The options are Disabled, and **Enhanced**.

Primary IDE Master/Slave, Secondary IDE Master/Slave, Third IDE Master, and Fourth IDE Master

These settings allow the user to set the parameters of Primary IDE Master/Slave, Secondary IDE Master/Slave, Third and Fourth IDE Master slots. Press <Enter> to activate the following submenu screen for details. Set the correct configurations accordingly. The items included in the submenu are:

Type

Use this feature to select the type of device connected to the system. The options are Not Installed, **Auto**, CD/DVD and ARMD.

LBA/Large Mode

LBA (Logical Block Addressing) is a method of addressing data on a disk drive. In the LBA mode, the maximum drive capacity is 137 GB. For drive capacities over 137 GB, your system must be equipped with a 48-bit LBA mode addressing. If not, contact your manufacturer or install an ATA/133 IDE controller card that supports 48-bit LBA mode. The options are Disabled and **Auto**.

Block (Multi-Sector Transfer)

Block Mode boosts the IDE drive performance by increasing the amount of data transferred. Only 512 bytes of data can be transferred per interrupt if Block Mode is not used. Block Mode allows transfers of up to 64 KB per interrupt. Select Disabled to allow data to be transferred from and to the device one sector at a time. Select Auto to allow data transfer from and to the device multiple sectors at a time if the device supports it. The options are **Auto** and Disabled.

PIO Mode

The IDE PIO (Programmable I/O) Mode programs timing cycles between the IDE drive and the programmable IDE controller. As the PIO mode increases, the cycle time decreases. The options are **Auto**, 0, 1, 2, 3, and 4.

Select Auto to allow the AMI BIOS to automatically detect the PIO mode. Use this value if the IDE disk drive support cannot be determined.

Select 0 ~ 4 to allow the AMI BIOS to use PIO mode 0 ~ 4. It has a data transfer rate of 3.3 MB/s ~ 16.6 MB/s. See the table below.

PIO Mode Select Options

Option Selected	PIO Mode	Max. Transfer Rate
0	PIO Mode 0	3.3 MB/s
1	PIO Mode 1	5.2 MB/s
2	PIO Mode 2	8.3 MB/s
3	PIO Mode 3	11.1 MB/s
4	PIO Mode 4	16.6 MB/s

DMA Mode

Select Auto to allow the BIOS to automatically detect IDE DMA mode when the IDE disk drive support cannot be determined. The options are **Auto**, SWDMAN, MWDMAN, and UDMAN. See the table below for DMA Mode Select Options.

DMA Mode Select Options

Option Selected	DMA Mode	Max. Transfer Rate
SWDMA 0	Single-Word DMA 0	2.1 MB/s
SWDMA1	Single-Word DMA 1	4.2 MB/s
SWDMA 2	Single-Word DMA 2	8.3MB/s
MWDMA 0	Multi-Word DMA 0	4.2 MB/s
MWDMA1	Multi-Word DMA 1	13.3 MB/s
MWDMA 2	Multi-Word DMA 2	16.6 MB/s
UDMA 0	Ultra DMA 0	16.6 MB/s
UDMA 1	Ultra DMA 1	25 MB/s
UDMA 2	Ultra DMA 2	33.3 MB/s
UDMA 3	Ultra DMA 3	44.4 MB/s
UDMA 4	Ultra DMA 4	66.6 MB/s
UDMA5	Ultra DMA 5	100 MB/s
UDMA 6	Ultra DMA 6	133 MB/s

S.M.A.R.T. For Hard disk drives

Self-Monitoring Analysis and Reporting Technology (SMART) can help predict impending drive failures. Select Auto to allow the AMI BIOS to automatically detect hard disk drive support. Select Disabled to prevent the AMI BIOS from using the S.M.A.R.T. Select Enabled to allow the AMI BIOS to use the S.M.A.R.T. to support hard drive disk. The options are Disabled, Enabled, and **Auto**.

32Bit Data Transfer

Select Enable to support 32-bit IDE data transfer. The options are **Enabled** and Disabled.

Hot Plug (Available when SATA#1 is Configured as RAID Intel/Adaptec or AHCI)

Select **Enable** to enable the hot plug function for the SATA devices. The options are **Enabled** and **Disabled**

IDE Detect Timeout (sec)

Use this feature to set the time-out value for the BIOS to detect the ATA, ATAPI devices installed in the system. The options are 0 (sec), 5, 10, 15, 20, 25, 30, and **35**.

► PCI/PnP Configuration

Clear NVRAM

This feature clears the NVRAM during system boot. The options are **No** and **Yes**.

Plug & Play OS

Selecting **Yes** allows the OS to configure Plug & Play devices. (This is not required for system boot if your system has an OS that supports Plug & Play.) Select **No** to allow the AMI BIOS to configure all devices in the system.

PCI Latency Timer

This feature sets the latency Timer of each PCI device installed on a PCI bus. Select **64** to set the PCI latency to 64 PCI clock cycles. The options are 32, **64**, 96, 128, 160, 192, 224 and 248.

PCI IDE Bus Master

Select **Enabled** for the BIOS to use PCI bus mastering to read from and write to IDE drives. The options are **Disabled** and **Enabled**.

SR-IOV Supported

Select **Enabled** to enable Single Root I/O Virtualization (SR-IOV) support that works in conjunction with the Intel Virtualization Technology and allow multiple operating systems running simultaneously within a single computer via natively share PCI-Express devices in order to enhance network connectivity and performance. The options are **Enabled** and **Disabled**.

Slot 1 Option ROM~Slot 6 Option ROM

Select **Enabled** to enable Slot 1 Option ROM~Slot 6 Option ROM, which will allow you to boot the computer from a PCI device installed on a PCI slot. The options are **Disabled** and **Enabled**.

Onboard LAN Option ROM Select

This feature allows the user to select the onboard LAN Option ROM type. The options are iSCSI and **PXE**.

LAN1 Option ROM/LAN2 Option ROM/LAN3 Option ROM/LAN4 Option ROM

Select Enabled to enable the onboard LAN1, LAN2, LAN3, or LAN4 Option ROM. This is to boot computer using a network interface. The options for LAN1 are **Enabled** and Disabled. The options for LAN2 - LAN 4 are **Disabled** and Enabled.

LSI SAS 1068 Option ROM

Select Enabled to enable LSI SAS 1068 Option ROM to boot the computer using a network interface. The options are **Enabled** and Disabled.

► Super IO Device Configuration

Onboard Floppy Controller

Select Enable to enable the onboard Floppy Controller. The options are **Enabled** and Disabled.

Floppy A

This feature allows the user to select the type of floppy drive connected to the system as specified. The options are Disabled, 360KB 5 1/4", 1.2MB 5 1/4", 720KB 3 1/2", 1.44MB 3 1/2" and 2.88MB 3 1/2". The default setting is **1.44MB 3 1/2"**.

Serial Port1 Address/ Serial Port2 Address

This option specifies the base I/O port address and the Interrupt Request address of Serial Port 1 and Serial Port 2. Select Disabled to prevent the serial port from accessing any system resources. When this option is set to Disabled, the serial port physically becomes unavailable. Select 3F8/IRQ4 to allow the serial port to use 3F8 as its I/O port address and IRQ 4 for the interrupt address. The options for Serial Port1 are Disabled, **3F8/IRQ4**, 3E8/IRQ5, and 2E8/IRQ3. The options for Serial Port2 are Disabled, **2F8/IRQ3**, 3E8/IRQ5, and 2E8/IRQ3.

Serial Port 2 Mode

Use this feature to configure Serial Port 2 mode. The options are **Normal**, IrDA and ASK IR. IrDA (Infrared Data) is an industry standard for remote control devices. ASK IR (Amplitude Shifted Keying Infrared) is a protocol compatible with Sharp® branded PDAs and other infrared devices.

Serial Port3 Address

This option specifies the base I/O port address and the Interrupt Request address of Serial Port 3. Select Disabled to prevent the serial port from accessing any

system resources. When this option is set to Disabled, the serial port physically becomes unavailable. Select 3E8/IRQ5 to allow the serial port to use 3E8 as its I/O port address and IRQ 5 for the interrupt address. The options are Disabled, and **3E8/IRQ5**.

► Remote Access Configuration

Remote Access

Select Enabled to enable Remote Access support. The options are Disabled and **Enabled**. If Remote Access is set to Enabled, the following items will display:

Serial Port Number

This feature allows the user decide which serial port to be used for Console Redirection. The options are COM 1, COM2, and **COM3**.

Base Address, IRQ

This item displays the base address and IRQ of the serial port used for Console Redirection.

Serial Port Mode

This feature allows the user to set the serial port mode for Console Redirection. The options are **115200 8, n, 1**; 57600 8, n, 1; 38400 8, n, 1; 19200 8, n, 1; and 9600 8, n, 1.

Flow Control

This feature allows the user to set the flow control for Console Redirection. The options are **None**, Hardware, and Software.

Redirection After BIOS POST

Select Disabled to turn off Console Redirection after Power-On Self-Test (POST). Select Always to keep Console Redirection active all the time after POST. (Note: This setting may not be supported by some operating systems.) Select Boot Loader to keep Console Redirection active during POST and when the Boot Loader is active. The options are Disabled, Boot Loader, and **Always**.

Terminal Type

This feature allows the user to select the target terminal type for Console Redirection. The options are **ANSI**, VT100, and VT-UTF8.

VT-UTF8 Combo Key Support

Select Enabled to use VT-UTF8 Combo as the keyboard type to send commands from a remote console. The options are **Enabled** and Disabled.

Sredir Memory Display Delay

This feature specifies the length of time in seconds to display memory information. The options are **No Delay**, Delay 1 Sec, Delay 2 Sec, and Delay 4 Sec.

► Hardware Health Configuration

This feature allows the user to monitor system health, and review the status of each item as displayed.

CPU Overheat Alarm

This option allows the user to select the CPU Overheat Alarm setting which determines when the CPU OH alarm will be activated to provide warning of possible CPU overheat.



Warning!

1. Any temperature that exceeds the CPU threshold temperature predefined by the CPU manufacturer may result in CPU overheat or system instability. When the CPU temperature reaches this predefined threshold, the CPU and system cooling fans will run at full speed.
2. To avoid possible system overheating, please be sure to provide adequate airflow to your system.

The options are:

- The Early Alarm: Select this setting if you want the CPU overheat alarm (including the LED and the buzzer) to be triggered as soon as the CPU temperature reaches the CPU overheat threshold as predefined by the CPU manufacturer.
- **The Default Alarm:** Select this setting if you want the CPU overheat alarm (including the LED and the buzzer) to be triggered when the CPU temperature reaches about 5°C above the threshold temperature as predefined by the CPU manufacturer to give the CPU and system fans additional time needed for CPU and system cooling. In both the alarms above, please take immediate action as shown below.

CPU1 Temperature/CPU2 Temperature/System Temperature

This feature displays current temperature readings for the CPU and the System.

The following items will be displayed for your reference only:

CPU1 Temperature/CPU2 Temperature

The CPU thermal technology that reports absolute temperatures (Celsius/Fahrenheit) has been upgraded to a more advanced feature by Intel in its newer

processors. The basic concept is each CPU is embedded by unique temperature information that the motherboard can read. This 'Temperature Threshold' or 'Temperature Tolerance' has been assigned at the factory and is the baseline on which the motherboard takes action during different CPU temperature conditions (i.e., by increasing CPU Fan speed, triggering the Overheat Alarm, etc). Since CPUs can have different 'Temperature Tolerances', the installed CPU can now send information to the motherboard what its 'Temperature Tolerance' is, and not the other way around. This results in better CPU thermal management.

Supermicro has leveraged this feature by assigning a temperature status to certain thermal conditions in the processor (Low, Medium and High). This makes it easier for the user to understand the CPU's temperature status, rather than by just simply seeing a temperature reading (i.e., 25°C). The CPU Temperature feature will display the CPU temperature status as detected by the BIOS:

Low – This level is considered as the 'normal' operating state. The CPU temperature is well below the CPU 'Temperature Tolerance'. The motherboard fans and CPU will run normally as configured in the BIOS (Fan Speed Control).

User intervention: No action required.

Medium – The processor is running warmer. This is a 'precautionary' level and generally means that there may be factors contributing to this condition, but the CPU is still within its normal operating state and below the CPU 'Temperature Tolerance'. The motherboard fans and CPU will run normally as configured in the BIOS. The fans may adjust to a faster speed depending on the Fan Speed Control settings.

User intervention: No action is required. However, consider checking the CPU fans and the chassis ventilation for blockage.

High – The processor is running hot. This is a 'caution' level since the CPU's 'Temperature Tolerance' has been reached (or has been exceeded) and may activate an overheat alarm.

User intervention: If the system buzzer and Overheat LED has activated, take action immediately by checking the system fans, chassis ventilation and room temperature to correct any problems.



Notes: 1. The system may shut down if it continues for a long period to prevent damage to the CPU.

2. The information provided above is for your reference only. For more information on thermal management, please refer to Intel's Web site at www.Intel.com.

System Temperature: The system temperature will be displayed (in degrees in Celsius and Fahrenheit) as it is detected by the BIOS.

Voltage Monitoring

CPU1 Vcore/CPU2 Vcore, CPU1 DIMM/CPU2 DIMM, 1.5V, 3.3V, 3.3VSB (V), 5V, 12V, and VBAT (Battery Voltage).

System FAN Monitor

Fan Speed Control Modes

This feature allows the user to decide how the system controls the speeds of the onboard fans. The CPU temperature and the fan speed are correlative. When the CPU on-die temperature increases, the fan speed will also increase for effective system cooling. Select "Full Speed/FS" to allow the onboard fans to run at full speed for maximum cooling. The FS setting is recommended for special system configuration or debugging. Select "Performance/PF" for better system cooling. The PF setting is recommended for high-power-consuming and high-density systems. Select "Balanced/BL" for the onboard fans to run at a speed that will balance the needs between system cooling and power saving. The BL setting is recommended for regular systems with normal hardware configurations. Select "Energy Saving/ES" for best power efficiency and maximum quietness. The Options are: Full Speed/FS, Performance/PF, **Balanced/BL**, and Energy Saving/ES.

Fan1 ~ Fan8 Reading

This feature displays the fan speed readings from fan interfaces Fan1 through Fan8. (Fan7 is CPU1 Fan and Fan8 is CPU2 Fan.)

► ACPI Configuration

Use this feature to configure Advanced Configuration and Power Interface (ACPI) power management settings for your system.

ACPI Aware O/S

Select Enabled to enable ACPI support if it is supported by the OS to control ACPI through the Operating System. Otherwise, disable this feature. The options are **Yes** and No.

ACPI Version Features

Use this feature to select the ACPI version to be supported by the system. The options are ACPI v1.0, **ACPI v2.0** and ACPI v3.0. Please refer to ACPI's website for further explanation: <http://www.acpi.info/>.

ACPI APIC Support

Select Enabled to include the ACPI APIC Table Pointer in the RSDT (Root System Description Table) pointer list. The options are **Enabled** and Disabled.

APIC ACPI SCI IRQ

If set to Enabled, APIC ACPI SCI IRQ is supported by the system. The options are Enabled and **Disabled**.

Headless Mode

Select Enabled to use the system to function without a keyboard, monitor and/or mouse. The options are Enabled and **Disabled**.

NUMA Support

Select Enabled to enable Non-Uniform Memory Access support for an "NUMA-Aware" OS to improve CPU performance. Select Disabled to provide better memory access for an "non-NUMA" OS. Select NUMA for SLES 11 for better CPU performance on a SUSE Linux Enterprise Server 11. The options are **Enabled**, Disabled and NUMA for SLES11.

WHEA Support

Select Enabled to enable Windows Hardware Error Architecture (WHEA) support which will provide a common infrastructure for the system to handle hardware errors on Windows platforms to reduce system crashes caused by hardware errors and to improve system recovery and health monitoring. The default setting is **Enabled**.

High Precision Event Timer

Select Enabled to activate the High Performance Event Timer (HPET) that produces periodic interrupts at a much higher frequency than a Real-time Clock (RTC) does in synchronizing multimedia streams, providing smooth playback and reducing the dependency on other timestamp calculation devices, such as an x86 RDTSC Instruction embedded in the CPU. The High Performance Event Timer is used to replace the 8254 Programmable Interval Timer. The options are **Enabled** and Disabled.

► IPMI Configuration

Intelligent Platform Management Interface (IPMI) is a set of common interfaces that IT administrators use to monitor system health and to manage the system as a whole. For more information on the IPMI specifications, please visit Intel's website at www.intel.com.

IPMI Firmware Revision

This item displays the IPMI Firmware Revision Number currently used in this system.

Status of BMC

Baseboard Management Controller (BMC) manages the interface between system management software and platform hardware. This displays the status code of the BMC micro controller.

►View BMC System Event Log

This feature displays the BMC System Event Log (SEL). It shows the total number of entries of BMC System Events. To view an event, select an Entry Number and press <Enter> to display the information as shown in the screen.

- SEL Entry Number
- SEL Record ID
- SEL Record Type
- Event Timestamp
- Generator ID
- Event Message Format Version
- Event Sensor Type
- Event Sensor Number
- Event Dir Type
- Event Data.

Clear BMC System Event Log

Clear BMC System Log

Select OK and press the <Enter> key to clear the BMC system log. Select Cancel to keep the BMC System log. The options are **OK** and Cancel.



Caution: Any cleared information is unrecoverable. Make absolutely sure that you no longer need any data stored in the log before clearing the BMC Event Log.

►Set LAN Configuration

Set this feature to configure the IPMI LAN adapter with a network address as shown in the following graphics.

Channel Number

Enter the channel number for the SET LAN Config command. This is initially set to [1]. Press "+" or "-" on your keyboard to change the Channel Number.

Channel Number Status

This feature returns the channel status for the Channel Number selected above: "Channel Number is OK" or "Wrong Channel Number".

► IP Address Configuration

This submenu displays the following IP Address Configuration information.

Parameter Selector

This item displays the parameter of your IP Address configuration.

IP Address Source

This feature allows the user to decide how an IP address is assigned to a client computer or network device. Select DHCP (Dynamic Host Configuration Protocol) to allow a client (computer or device) to obtain an IP address from a DHCP server that manages a pool of IP addresses and network information on a "request and grant" basis. Upon time-out (or lease expiration), the IP address assigned to the client can be reassigned to a new client. Select **Static** (Static Allocation) to allow the host server to allocate an IP address based on a table containing MAC Address/IP Address pairs that are manually entered (probably by a network administrator). Only clients with a MAC address listed in the MAC/IP Address Table will be assigned an IP address. The IP Address allocated to the client is on a longer term basis than that assigned by the DHCP mentioned in the other option. The options are **DHCP** and **Static**.

IP Address

This item displays the IP address of this computer. The value of each three-digit number separated by dots should not exceed 255.

Current IP Address in BMC

This item displays the current IP address used for your IPMI connection.

► MAC Address Configuration

This submenu displays the following MAC Address Configuration information.

Parameter Selector

Use this feature to select the parameter of your Mac Address configuration.

MAC Address

This item displays the MAC address of this computer, which are 6 two-digit hexadecimal numbers (Base 16, 0 ~ 9, A, B, C, D, E, F) separated by dots. The value of each three-digit number separated by dots should not exceed 255.

Current MAC Address in BMC

This item displays the current MAC address used for your IPMI connection.

►Subnet Mask Configuration

Subnet masks tell the network which subnet this machine belongs to. The value of each three-digit number separated by dots should not exceed 255.

Parameter Selector

Use this feature to select the parameter of your Subnet Masks configuration.

Subnet Mask

This item displays the current subnet mask setting for your IPMI connection. If "Static" is selected, the subnet mask setting can be entered. The value of each three-digit number separated by dots should not exceed 255.

Current Subnet Mask in BMC

This item displays the current Subnet Mask used for your IPMI connection. The value of each three-digit number separated by dots should not exceed 255.

►Gateway Address

This is the IP address of the gateway in the network that the system is connected to. It's usually a router. If "Static" is selected, the subnet mask setting can be entered. The value of each three-digit number separated by dots should not exceed 255.

Parameter Selector

Use this feature to select the parameter of your Gateway Address settings.

Gateway Address

If DHCP is selected under IP Address Source, the DHCP server will automatically assign the IP address of the Gateway device to this machine. If you want this machine to use a different Gateway, please select Static under the IP Address Source and manually enter the Gateway address of your choice to this machine.

Current Gateway Address in BMC

This item displays the current Gateway address used for your IPMI connection.

► Event Log Configuration

View Event Log

Use this option to view the System Event Log.

Mark all events as read

Select OK to mark all events as read. The options are **OK** and Cancel.

Clear event log

Select OK to clear the Event Log memory of all messages. The options are **OK** and Cancel.

PCIe Error Log

Select Yes to enable PCI-Express error (PERR) logging. The options are **Yes** and No.

4-4 Security Settings

The AMI BIOS provides an option for you to set a Supervisor and a User password. If you use both passwords, the Supervisor password must be set first.

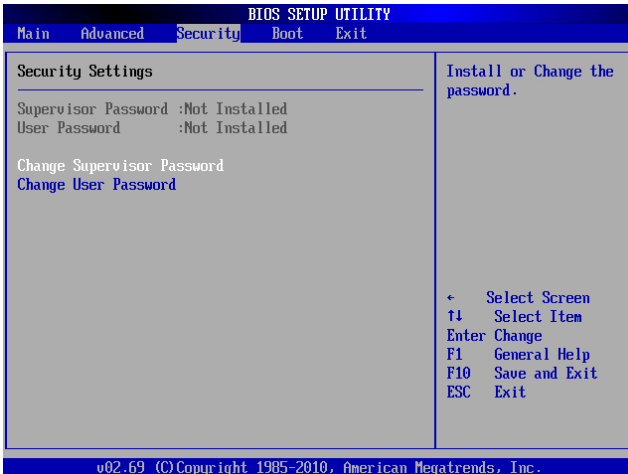

Supervisor Password

This item indicates if a Supervisor password has been entered for the system. "Not Installed" means a Supervisor password has not been used.

User Password

This item indicates if a user password has been entered for the system. "Not Installed" means that a user password has not been used.

Change Supervisor Password

Select this feature and press <Enter> to access the submenu, and then enter a new Supervisor Password.

User Access Level (Available when Supervisor Password is set as above)

Use this feature to set the user's access level. The options are:

- **Full Access:** grants full User read and write access to the Setup Utility,
- **View Only:** allows the user to access to the Setup Utility, but cannot change the fields,
- **Limited:** allows the user to change limited fields such as Date and Time,
- **No Access:** prevents the user from accessing the Setup Utility.

Change User Password

Select this feature and press <Enter> to access the submenu, and then enter a new User Password.

Clear User Password (Available only if User Password has been set)

This item allows you to clear a user password after it has been entered.

Password Check

This item allows you to check a password after it has been entered. The options are **Setup** and **Always**.

4-5 Boot Configuration

Use this feature to configure boot settings.



► Boot Device Priority

Use this feature to specify the sequence of Boot Device Priority. The settings are 1st boot device ~ 6th boot device and Disabled.

► Hard Disk Drives

Use this feature to specify the boot sequence from all available hard disk drives. The settings are Disabled and available HDDs (i.e., 1st Drive, 2nd Drive, 3rd Drive).

► Removable Drives

Use this feature to specify the boot sequence from available Removable Drives. The settings are 1st boot device, 2nd boot device, and Disabled.

► CD/DVD Drives

Use this feature to specify the boot sequence from available CD/DVD Drives (1st Drive, 2nd Drive).

► USB Drives

Use this feature to specify the boot sequence from available USB Drives (1st Drive, 2nd Drive).

► Network Drives

Use this feature to specify the boot sequence from available Network Drives (1st Drive, 2nd Drive).

► Other Drives

Use this feature to specify the boot sequence from other available Drives (1st Drive, 2nd Drive).

Retry Boot Devices

If this item is enabled, the BIOS will automatically attempt to boot from a specified boot device again after its initial failure to boot. The options are Enabled and Disabled.

4-6 Exit Options

Select the Exit tab from the AMI BIOS Setup Utility screen to enter the Exit BIOS Setup screen.

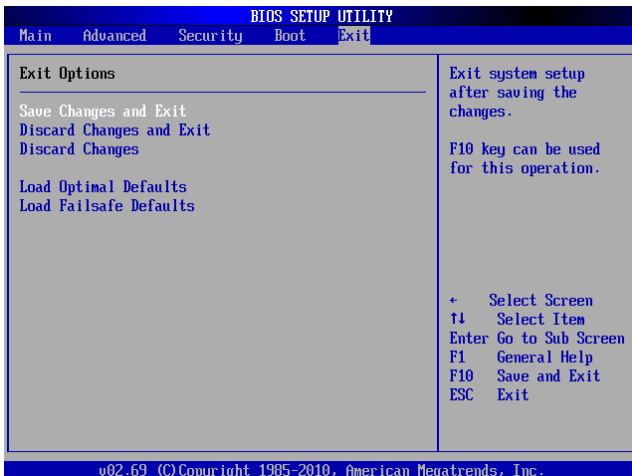

Save Changes and Exit

After you have changed the system configuration settings, select this option to leave the BIOS Setup Utility and reboot the computer so that the new system configuration parameters can take effect.

Discard Changes and Exit

Select this option to quit the BIOS Setup without making any permanent changes to the system configuration, and reboot the computer.

Discard Changes

Select this option and press <Enter> to discard all the changes and return to the AMI BIOS Utility Program.

Load Optimal Defaults

To set this feature, select Load Optimal Defaults from the Exit menu and press <Enter>. Then, select OK to allow the AMI BIOS to automatically load Optimal Defaults to the BIOS Settings. The Optimal settings are designed for maximum system performance, but may not work best for all computer applications.

Load Fail-Safe Defaults

To set this feature, select Load Fail-Safe Defaults from the Exit menu and press <Enter>. The Fail-Safe settings are designed for maximum system stability, but not for maximum performance.

Appendix A

BIOS Error Beep Codes

During the POST (Power-On Self-Test) routines, which are performed each time the system is powered on, errors may occur.

Non-fatal errors are those which, in most cases, allow the system to continue the boot-up process. The error messages normally appear on the screen.

Fatal errors will not allow the system to continue the boot-up procedure. If a fatal error occurs, you should consult with your system manufacturer for possible repairs.

A-1 BIOS Error Beep Codes

BIOS Error Beep Codes		
Beep Code	Error Message	Description
1 beep	Refresh	Circuits have been reset. (Ready to power up)
5 short beeps + 1 long beep	Memory error	No memory detected in the system
8 beeps	Display memory read/write error	Video adapter missing or with faulty memory
1 continuous beep (with the front panel OH LED on)	System Overheat	1 continuous beep with the front panel OH LED on

Notes

Appendix B

Software Installation Instructions

B-1 Installing Software Programs

After you've installed the Windows Operating System, a screen as shown below will appear. You are ready to install software programs and drivers that have not yet been installed. To install these software programs and drivers, click the icons to the right of these items. (**Note:** To install the Windows OS, please refer to the instructions posted on our website at <http://www.supermicro.com/support/manuals/>.)

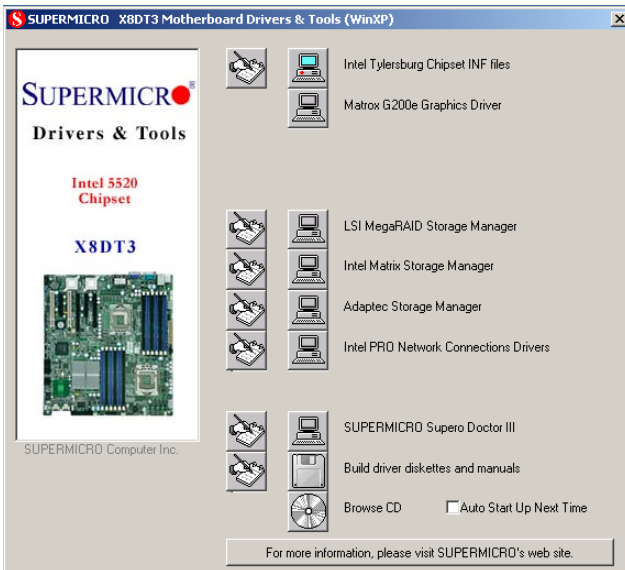

Driver/Tool Installation Display Screen



Note 1: Click the icons showing a hand writing on the paper to view the readme files for each item. Click on a computer icon to the right of an item to install an item (from top to the bottom) one at a time. After installing each item, you must re-boot the system before proceeding with the next item on the list. The bottom icon with a CD on it allows you to view the entire contents of the CD.

Note 2: When making a storage driver diskette by booting into a Driver CD, please set the SATA Configuration to "Compatible Mode" and configure SATA as IDE in the BIOS Setup. After making the driver diskette, be sure to change the SATA settings back to your original settings.

B-2 Configuring Supero Doctor III

The Supero Doctor III program is a web-based management tool that supports remote management capability. It includes Remote and Local Management tools. The local management is called the SD III Client. The Supero Doctor III program included on the CDROM that came with your motherboard allows you to monitor the environment and operations of your system. Supero Doctor III displays crucial system information such as CPU temperature, system voltages and fan status. See the Figure below for a display of the Supero Doctor III interface.



Note: 1 The default user name and password are ADMIN.

Note 2: In the Windows OS environment, the Supero Doctor III settings take precedence over the BIOS settings. When first installed, Supero Doctor III adopts the temperature threshold settings previously set in BIOS. Any subsequent changes to these thresholds must be made within Supero Doctor, since the SD III settings override the BIOS settings. For the Windows OS to adopt the BIOS temperature threshold settings, please change the SDIII settings to be the same as those set in BIOS.

Supero Doctor III Interface Display Screen-I (Health Information)



Supero Doctor III Interface Display Screen-II (Remote Control)



Note: SD III Software Revision 1.0 can be downloaded from our Web site at: ftp://ftp.supermicro.com/utility/Supero_Doctor_III/. You can also download SDIII User's Guide at: <http://www.supermicro.com/PRODUCT/Manuals/SDIII/UserGuide.pdf>. For Linux, we will still recommend that you use Supero Doctor II.

Notes

(Disclaimer Continued)

The products sold by Supermicro are not intended for and will not be used in life support systems, medical equipment, nuclear facilities or systems, aircraft, aircraft devices, aircraft/emergency communication devices or other critical systems whose failure to perform be reasonably expected to result in significant injury or loss of life or catastrophic property damage. Accordingly, Supermicro disclaims any and all liability, and should buyer use or sell such products for use in such ultra-hazardous applications, it does so entirely at its own risk. Furthermore, buyer agrees to fully indemnify, defend and hold Supermicro harmless for and against any and all claims, demands, actions, litigation, and proceedings of any kind arising out of or related to such ultra-hazardous use or sale.